

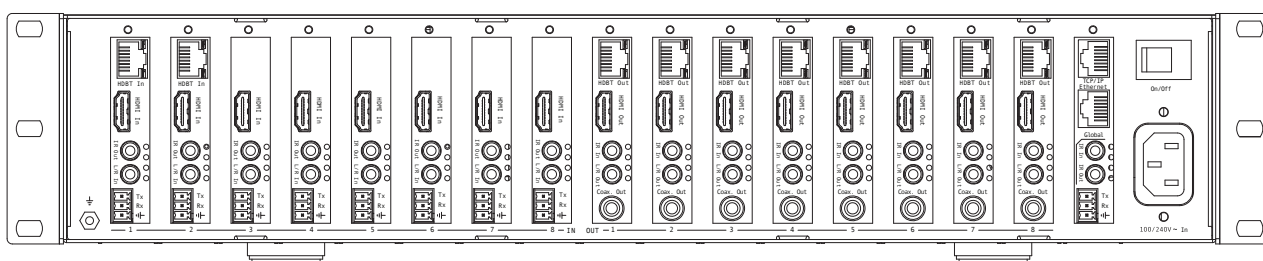

ELAN[®]

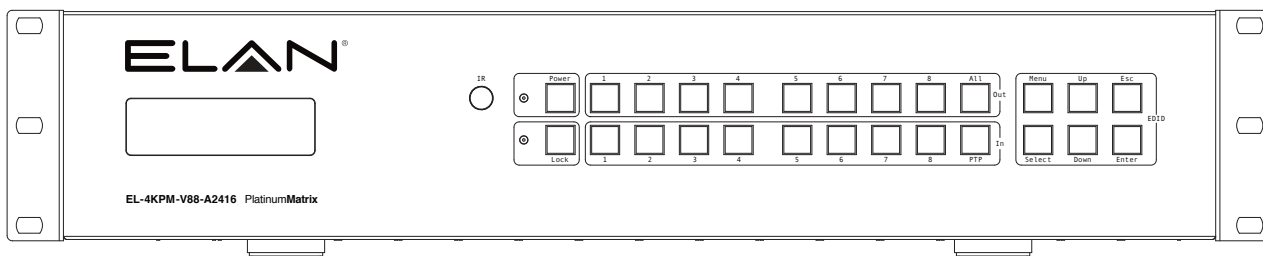

EL-4KPM-V88-A2416 Video/Audio Premium Matrix User Manual



Thank you for purchasing this product.

For optimum performance and safety, please read these instructions carefully before connecting, operating or adjusting this product. Please keep this manual for future reference.



Surge protection device recommended

This product contains sensitive electrical components that may be damaged by electrical spikes, surges, electric shock, lightning strikes, etc. Use of surge protection systems is highly recommended in order to protect and extend the life of your equipment.

Safety And Performance Notice

The transmission distances of HDMI over UTP cables are measured using TE CONNECTIVITY 1427071-6

EIA/TIA-568-B termination (T568B) of cables is recommended for optimal performance.

To minimize interference of the unshielded twisted pairs in the CAT5e/6 cable do not run the HDBaseT / Cat5e/6/6a cabling with or in close parallel proximity to mains power cables.

Do not substitute or use any other power supply other than the enclosed unit, or a ELAN approved replacement.

Do not disassemble either the Transmitter or Receiver units for any reason. Doing so will void the manufacturer's warranty.

Contents

Introduction_____03

Features_____03

Panel Descriptions_____04

Matrix Main Com Board_____05

Matrix HDBaseT Receiver Options_____06

EDID Control_____07

Terminating HDBaseT Cat Cable_____08

Understanding the Matrix/Receiver Status Lights__08

Infrared Distribution_____09

Infrared Remote Control _____10

Application Diagram_____11

Specifications_____12

Package Contents_____12

Maintenance_____12

Infrared Commands_____13-14

RS-232 and Telnet Commands_____15-16

Certifications_____17

Introduction

Our Premium Series of HDBaseT matrix products offer the very best performance and flexibility for the custom installer. Built with the custom installer in mind, any combination of inputs and outputs can be specified to suit the exact AV distribution needs of the project. The ELAN EL-4KPM-V88-A2416 include both HDBaseT/HDMI inputs and outputs allowing extension of HDMI signal of up to 100m*. The built-in audio matrix with HDMI/analog/digital embedding and de-embedding further adds audio distribution capabilities enabling you to provide your clients with a feature rich solution.

EL-4KPM-V88-A2416 Features:

- 8x HDMI inputs which can be independently routed to 8x HDBaseT/HDMI video outputs (quantity dependent on model)
- 4K video support
- Supports distances of up to 100m @ 1080p & 70m @ 4K on a single CAT cable
- 2x HDBaseT inputs allowing sources to be located remotely using ELAN HDBaseT transmitters
- Supports POH (Power Over HDBaseT) to power ELAN transmitters and receivers - no local power supplies required
- LAN serving (Ethernet Switch) with compatible ELAN receivers
- Integrated 24 Input x 16 Output Audio Matrix
- Audio Return Channel (ARC) with compatible ELAN HDBaseT receivers
- Analog audio L/R embedding onto HDMI outputs
- HDMI Audio de-embedding to analog audio L/R + digital coaxial outputs
- Bi-directional RS-232 and IR from all input and output locations (with compatible ELAN transmitters and receivers)
- Web interface module for control & configuration of the matrix
- Control of Matrix via front panel, IR, RS-232 & TCP/IP
- Advanced EDID management
- HDCP2.2 Compliant

Panel Descriptions

Front Panel

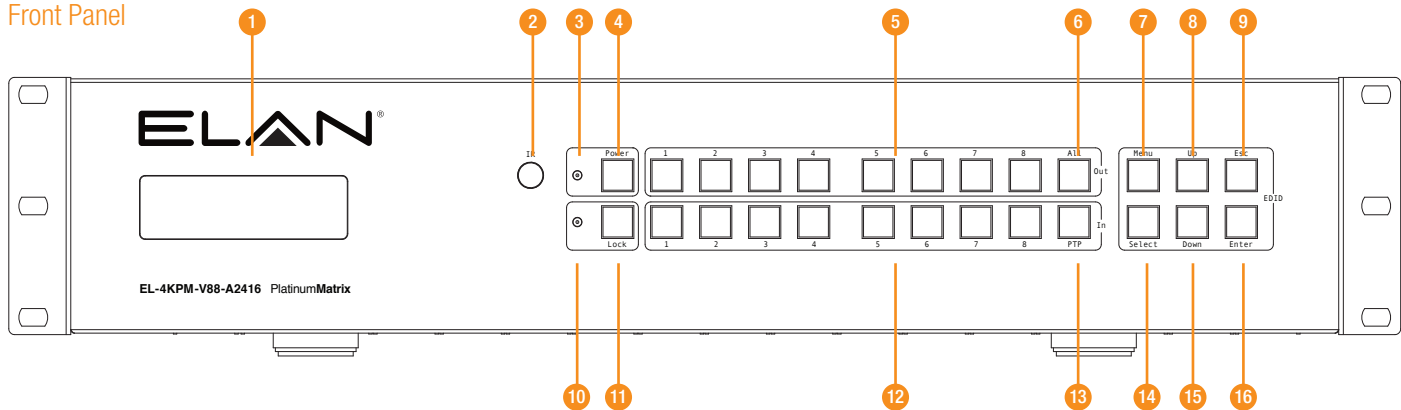

- 1 LCD display – Show the status of input & output selection and EDID info.
- 2 IR receiver window – Receives IR from a hand held remote control or processor.
- 3 Power LED indicator - Indicates the power status of the matrix.
- 4 Power button – Press to toggle power of the matrix on/off
- 5 HDMI output selection button 1 to 8 – Press to select the output from 1 to 8.
- 6 All button for HDMI outputs – Press to select all of the outputs from 1 to 8.
- 7 Menu button – Press to enter EDID setup
- 8 Up – Press to change up through the adjustable values.
- 9 ESC - Press to quit EDID set up menu.
- 10 Lock LED indicator - Indicate the status of the key lock
- 11 Lock button – Press to lock the buttons on the front panel (Press and hold for 2 seconds)
- 12 HDMI input selection button 1 to 8 – Press to select the input from 1 to 8.
- 13 PTP button-Press to mirror all inputs and outputs (e.g. output 1 to input1, output 2 to input2 and so on).
- 14 Select – Press to select an EDID parameter to change. Selected segment will blink.
- 15 Down – Press to change down through the adjustable values
- 16 Enter – Press to set EDID to specified INPUT or copy EDID from specified OUTPUT to specified INPUT.

Rear Panel

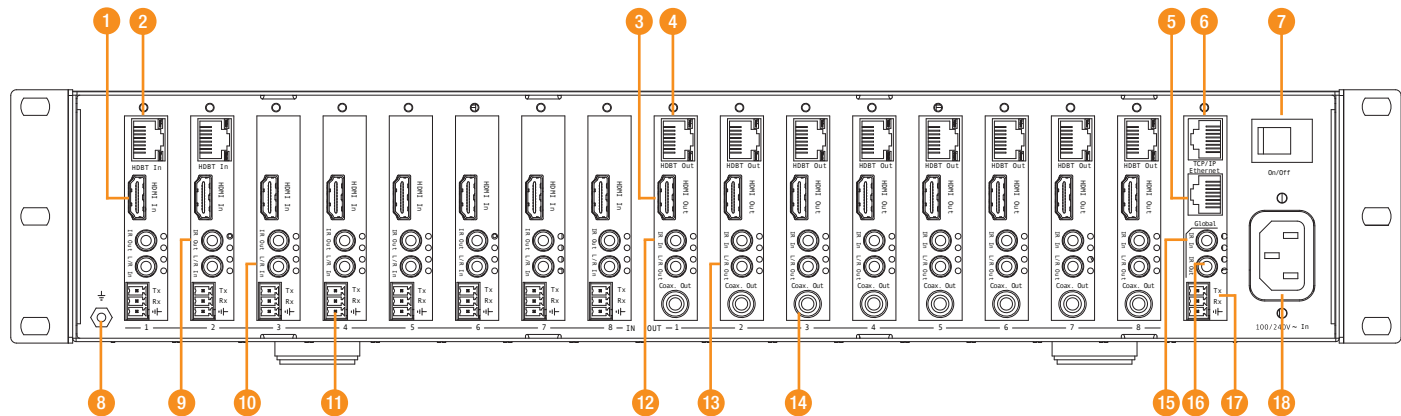

- 1 HDMI inputs 1 to 8 – Connect HDMI sources
- 2 HDBT inputs 1&2 – Connect remote HDBT transmitter
- 3 HDMI outputs 1 to 8 – Output for displays.
- 4 HDBT outputs 1 to 8 – Output for displays.
- 5 Ethernet-embedded for LAN serving to all connected HDBT transmitters and receivers
- 6 RJ45 - TCP/IP control
- 7 Power switch
- 8 GND – Ground connection
- 9 RS-232 port – Connect to this port for the control of the matrix from a computer or control processor.
- 10 L/R stereo inputs 1 to 8 – 3.5mm stereo jack
- 11 IR outputs 1 to 8 – 3.5mm mono jack for routed IR emitter outputs for discrete source control.
- 12 Coaxial Digital outputs 1 to 8 – RCA connector.
- 13 L/R stereo outputs 1 to 8 – 3.5mm stereo jack.
- 14 IR Inputs 1 to 8 – 3.5mm stereo jack for integration with a control processor.
- 15 RS-232 Port – 1x 3-pin phoenix terminal
- 16 Global IR Output – 3.5mm mono jack.
- 17 Global IR Input – 3.5mm stereo jack.
- 18 AC power input – 100V-240V input.

Matrix Main Com Board

The Matrix main communication board is located on the rear panel and has the following connections:-

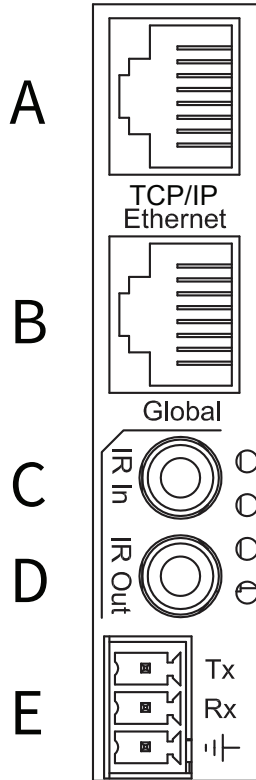

Connections:

- A. TCP/IP – For control of Matrix (RJ45 Connector)
- B. Ethernet – Matrix includes 1x16 10/100 Ethernet switch (RJ45 Connector)
- C. Global IR Input 3.5mm stereo jack
- D. Global IR Output 3.5mm mono jack
- E. RS-232 2-way (Phoenix Connector)

TCP/IP

The ELAN Matrix can be controlled via TCP/IP.

For full list of protocols please see ‘RS-232 & Telenet Commands’ located at the rear of this manual.

A ‘Straight-through’ RJ45 patch lead should be used

RS-232 2-Way

The ELAN matrix can be controlled via supplied 3-pin Phoenix to 9-pin serial cable

For full list of protocols please see ‘RS-232 & Telenet Commands’ located at the rear of this manual.

Details of RS-232 pin assignment and communication are below:

MT0808-FAV		REMOTE CONTROL CONSOLE	
PIN	Assignment	PIN	Assignment
1	NC	1	NC
2	Tx	2	Rx
3	Rx	3	Tx
4	NC	4	NC
5	GND	5	GND
6	NC	6	NC
7	NC	7	NC
8	NC	8	NC
9	NC	9	NC

Baud Rate: 57600 bps

Data Bit: 8-bit

Parity: None

Stop Bit: 1-bit

Flow Control: None

Matrix HDBaseT Receiver Options

There are four HDBaseT receiver options that are compatible with the outputs on the ELAN Premium Series products.

EL-4KHDBT-RX-70-E-ARC-IRS

Premium HDBaseT receiver which features 2-way IR & RS232, HDMI ARC display distances up to 100m*. Only compatible with EL-4KPM-V88-A2416 and EL-4KPM-V66-A1812 ELAN Premium Matrix products.

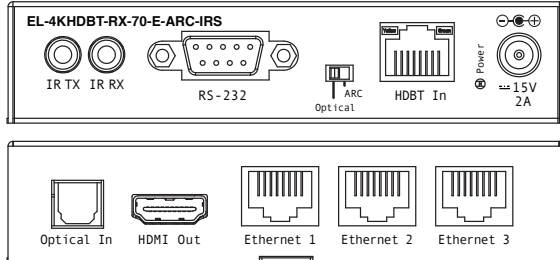

- HDBaseT input/HDMI Output
- Optical Audio input (Toslink)
- 2-way RS232 (9-pin serial)
- IR Output 3.5mm Mono Jack
- IR Input 3.5mm Mono Jack
- 3x 10/100 Ethernet connections (RJ45)

EL-4KHDBT-RX-40-IRS

Mid-Level HDBaseT receiver which has the same features as the EL-4KHDBT-RX-70-ARC receiver but with added 2-way RS-232 control.

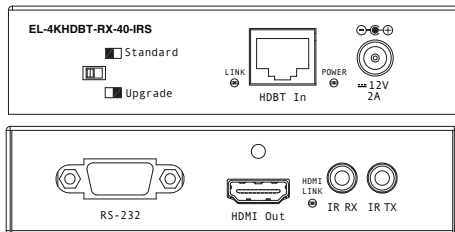

- HDBaseT input/HDMI output
- 2-way RS232 (9-pin serial)
- IR Output 3.5mm mono jack
- IR Input 3.5mm stereo jack

EL-4KHDBT-RX-40-IR

Basic HDBaset Receiver with 2-way IR pass-through. Supports distances up to 70m*.

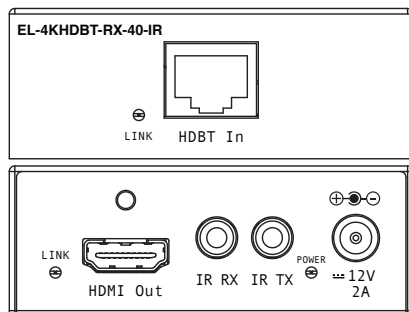

- HDBaseT input/HDMI output
- IR Output 3.5mm mono jack
- IR Input 3.5mm stereo jack

EDID Control

EDID (Extended Display Identification Data) is a data structure that is used between a display and a source. This data is used by the source to find out what audio and video resolutions are supported by the display then from this information the source will discover what the best audio and video resolutions need to be outputted.

While the objective of EDID is to make connecting a digital display to a source a simple plug and play procedure issues do arise when multiple displays or video matrix switching is introduced because of the increased number of variables.

By pre-determining the video resolution and audio format of the source and display device you can reduce the time need for EDID hand shaking thus making switching quicker and more reliable.

32				10				EDID TYPE
Combination of DIP positions								
0	0	0	0	0	0	0	0	Copy EDID from output1
0	0	0	0	0	0	0	1	1080P 2.0CH
0	0	0	0	0	0	1	0	1080P 5.1CH
0	0	0	0	0	0	1	1	1080P 7.1CH
0	0	1	0	0	0	0	0	1080i 2.0CH
0	0	1	0	0	0	1	1	1080i 5.1CH
0	0	1	0	1	0	0	0	1080i 7.1CH
0	1	1	1	1	1	1	1	4K60Hz 4:2:0 2.0CH
1	0	0	0	0	0	0	0	4K60Hz 4:2:0 5.1CH
1	0	0	0	0	1	1	1	4K60Hz 4:2:0 7.1CH
1	0	1	1	0	0	0	0	4K30Hz 4:4:4 2.0CH
1	0	1	1	0	1	1	1	4K30Hz 4:4:4 5.1CH
1	1	0	0	0	0	0	0	4K30Hz 4:4:4 7.1CH
1	1	0	1	0	1	1	1	DVI 1280x1024
1	1	1	1	0	0	0	0	DVI 1920x1080
1	1	1	1	1	1	1	1	DVI 1920x1200

Configuration of the EDID settings can be achieved in one of three ways:

- 1 Via the Web GUI
- 2 Via Front Panel Buttons
 - a. Press **MENU** button
 - b. Panel will display 'EDID settings. Press **SELECT** button
 - c. Select the input you wish to fix the EDID on or select 'All'. Use **UP/DOWN** buttons to toggle selection and **SELECT** button to confirm
 - d. Select video resolution required (4K, 1080p, 3D etc). Use **UP/DOWN** buttons to toggle selection and **SELECT** button to confirm
 - e. Select audio format required (2.0, 5.1, 7.1). Use **UP/DOWN** buttons to toggle selection and **SELECT** button to confirm
- 3 Via Supplied IR Remote Control
 - a. Fixed EDID to INPUT / ALL INPUTS:
 - To select video resolution - Press **1080i/1080P/3D/4K**
 - To select Audio resolution - Press **2.0CH/5.1CH/7.1CH**
 - To assign settings to individual input/all inputs – Press **INPUT / ALL** button in 'ZONE INPUT' area of remote control
 - b. Copy EDID of any specific OUTPUT to any assigned INPUT or ALL INPUTS:
 - Press **COPY** button
 - Press **OUTPUT** zone button you wish to copy EDID from
 - Press **INPUT** zone button /ALL button to copy EDID to
 - c. User defined EDID to any INPUT or ALL INPUTS:
 - Press **USER1/USER2** button
 - Press selected **INPUT** or **ALL** button to assign EDID

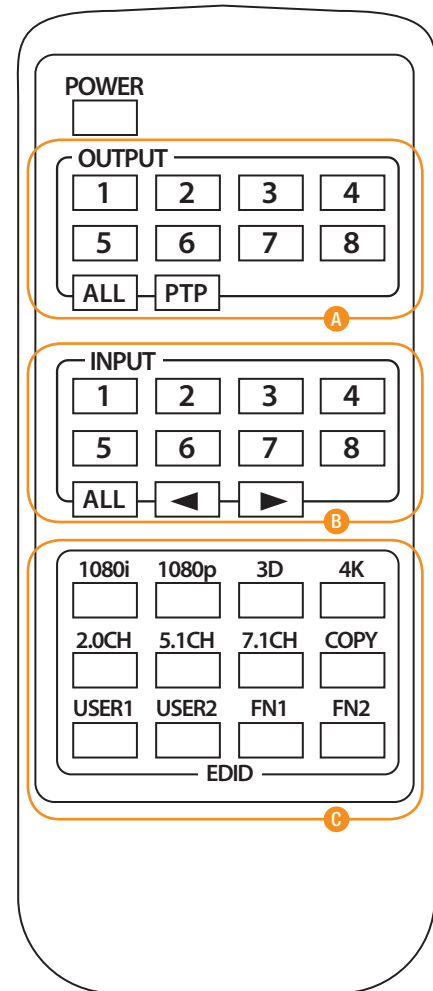

Terminating HDBaseT CAT cable

It is important that the interconnecting CAT cable between the ELAN HDBaseT products is terminated using the correct RJ45 pin configuration. The link CAT cable **MUST** be a 'straight' (pin-to-pin) CAT cable and it is advised that this is wired to the T568B wiring standard as this format is less prone to EMI (Electro-Magnetic Interference).

When installing CAT cables it is advised that you use the best possible CAT cable quality possible. HDMI distribution products will only work if used with CAT5e standard cable or above. ELAN recommends using a CAT6 cable for your installations, especially when running over longer distances, in areas of high EMI, or for 4K signal distribution.

RJ45 Wiring - T568B

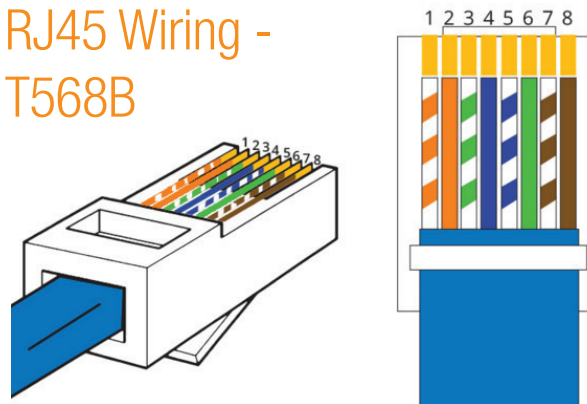

Understanding the Matrix / Receiver HDBaseT status lights

The ELAN Matrix and HDBaseT extender solutions include status LED indicators on both the Matrix and Receiver products to show all connections are active and to help diagnose possible problems.

Understanding the status lights:-

ELAN Matrix:

- The Yellow HDBaseT status link light will be off when the zone output has been turned off or there is a problem with the specific Matrix output.
- The Yellow HDBaseT status link light will blink when the zone output is on and working
- The Green HDBaseT link light will blink if there is an unstable connection between the ELAN Matrix and HDBaseT Receiver
- The Green HDBaseT link light will be lit when there is an active HDBaseT Receiver connected to the Matrix
- The Green HDBaseT link light will be off when there is no connection with a HDBaseT receiver

ELAN HDBaseT Receiver:

- The HDMI link light will be off when there is no connection with a display
- The HDMI link light will be on when there is an active connection with a display (NOTE - Not all HDBaseT RX feature a HDMI status LED)
- The HDBaseT link light will be off when there is no CAT cable/active HDBaseT connection on the RJ45 HDBaseT input
- The HDBaseT link light will blink if there is an unstable connection between the ELAN Matrix and HDBaseT receiver
- The HDBaseT link light will be lit when a CAT cable is connected to the HDBaseT RJ45 output on the Matrix and an active connection is achieved with the ELAN HDBaseT Receiver.



Infrared (IR) Distribution

The ELAN Premium Series of matrix products include multiple options for control and routing of IR. As default setting IR is globally routed meaning that ALL IR inputs are routed to ALL IR outputs on both Matrix and HDBaseT Receivers and Transmitters.

IMPORTANT: The ELAN HDMI Premium, Matrix, & HDBaseT product lines utilize 5 volts to power an IR Receiver on the IR Input and include an EL-4KACC-IR-CAB, 3.5mm Mono to 3.5mm Stereo 5v to 12v IR converter cable. This cable is required when using 12v IR products from Xantech, Niles, and SpeakerCraft.

Each ELAN Matrix and HDBaseT receiver is supplied with all necessary IR hardware required and includes:

IR Control Cable - EL-4KACC-IR-CAB

ELAN IR Control cable 3.5mm Mono to 3.5mm Stereo for linking third party IR Receivers to ELAN Premium, Matrix, and HDBaseT HDMI Series products.

Compatible with 12v IR third party products.

Note: Cable is directional as indicated

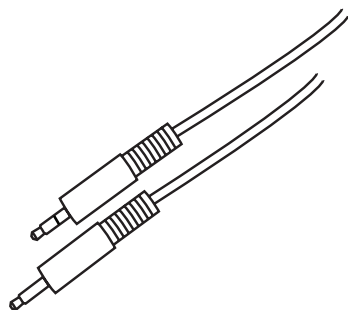

Infrared 3.5mm Pin-Out

IR Emitter - Mono 3.5mm

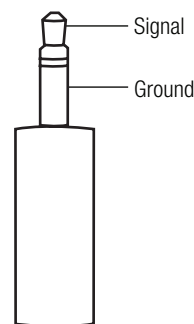

IR Receiver - Stereo 3.5mm

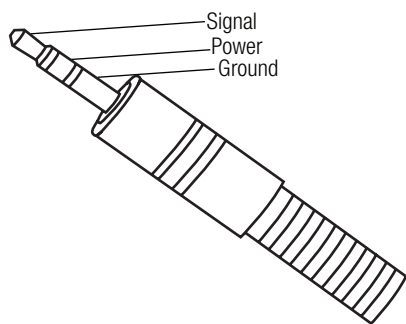

Infrared (IR) Control

The ELAN Premium Series matrix units are supplied with IR Remote Control for source selection and general setup.

As well as controlling matrix solutions using the original ELAN remote the ELAN products can be controlled using the original Infrared NEC codes shown at the rear of this manual.

Remote Control Description

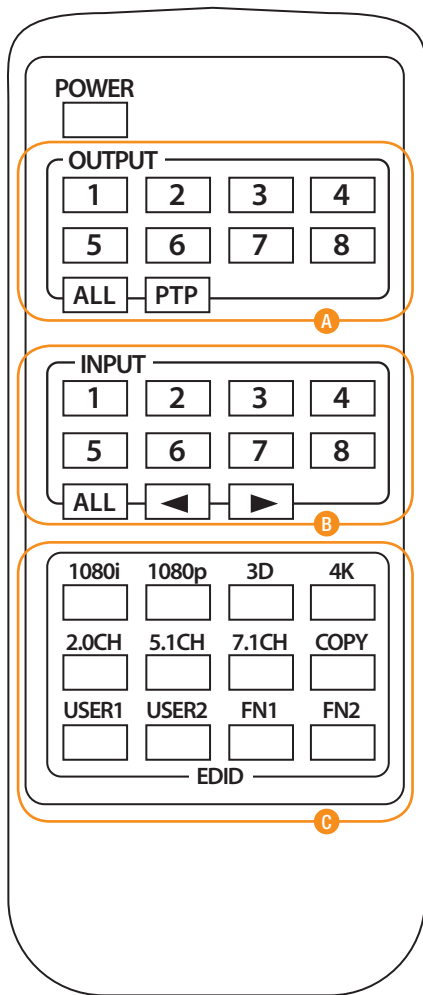

OUTPUT AND INPUT SELECTION

- A** Select the zone OUTPUT you wish to change the source on (Numbers 1-8 correspond to the zone outputs 1-8).
- B** Select the source INPUT you wish to change on the selected zone to (Numbers 1-8 corresponds to the source inputs 1-8)
- C** Press PTP button If you wish to instantly mirror all inputs and outputs (Example - Input 1 to output 1, input 2 to output 2 etc).

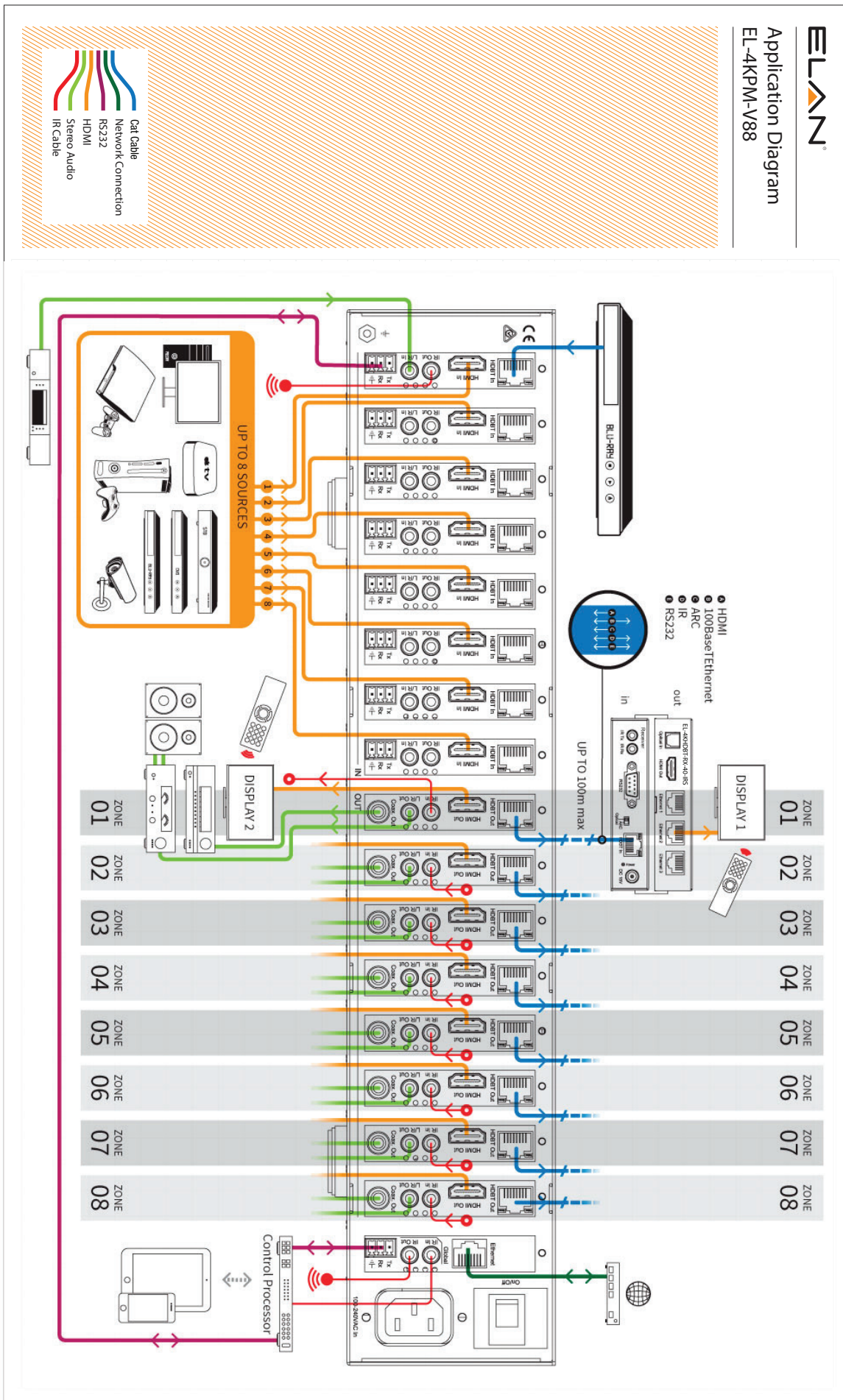

Specifications

Video Input Connections: 8x HDMI Type A, 19-pin, female, 2x HDBaseT RJ45 connector

Video Output Connections: 8x HDMI Type A, 19-pin, female, 8x HDBaseT RJ45 connector

Audio Input Connections: 8x 3.5mm stereo jack (L/R)

Audio Output Connections: 8x RCA (SPDIF), 8x 3.5mm stereo jack (L/R)

RS-232 serial ports: 9x 3-Pin Phoenix connector

TCP/IP Control: RJ45, female

Ethernet/Network: RJ45, female

IR Input ports: 9x 5v 3.5mm stereo jack

IR Output ports: 9x 5v 3.5mm mono jack

Rack-Mountable: 2U rack height, rack ears included

Casing Dimensions (W x H x D): 440mm x 87mm x 361mm, without feet

Dimensions Including Connections (W x H x D): 440mm x 87mm x 369mm, with feet

Shipping Weight: 8.8kg

Operating Temperature: 32°F to 104°F (0°C to 40°C)

Storage Temperature: -4°F to 140°F (-20°C to 60°C)

Input: 100V-250V, 50Hz-60HZ, 13A

NOTE: Specifications are subject to change without notice. Weight details are approximate and will alter per model.

Package Contents:

- 1 x EL-4KPM-V88-A2416
- 1 x Remote control
Remote Includes CR2025 battery
- 1 x Rack mounting kit
- 8 x 5v-to-12v IR converter cables
- 2 x Serial cable - 9-pin RS-232 to 3-pin phoenix connector
- 1 x User manual
- 4 x Power cables (Type A, C, G & I)

Maintenance

Clean this unit with a soft, dry cloth. Never use alcohol, paint thinner or benzene to clean this unit.

COMMAND	NEC	HEX
1080i	OX18	0000 006D 0000 0022 0157 00AC 0016 0016 0016 0016 0016 0016 0016 0016 003F 0016 003F 0016 0016 0016 0016 0016 0016 0016 0016 0016 0016 0016 0016 0016 0016 003F 0016 003F 0016 0016 0016 0016 0016 0016 003F 0016 003F 0016 003F 0016 003F 0016 003F 0016 0016 0016 0016 003F 0016 003F 0016 003F 0016 0689
1080p	OX44	0000 006D 0000 0022 0157 00AC 0016 0016 0016 0016 0016 0016 0016 0016 003F 0016 003F 0016 0016 0016 0016 0016 0016 0016 0016 0016 0016 0016 0016 0016 0016 003F 0016 003F 0016 0016 0016 0016 0016 0016 003F 0016 003F 0016 003F 0016 003F 0016 0016 0016 0016 003F 0016 003F 0016 003F 0016 0689
3D	OX0F	0000 006D 0000 0022 0157 00AC 0016 0016 0016 0016 0016 0016 0016 0016 003F 0016 003F 0016 0016 0016 0016 0016 0016 0016 0016 0016 0016 0016 0016 0016 0016 003F 0016 003F 0016 0016 0016 0016 0016 0016 003F 0016 003F 0016 003F 0016 003F 0016 0016 0016 0016 003F 0016 003F 0016 003F 0016 0689
4K	OX51	0000 006D 0000 0022 0157 00AC 0016 0016 0016 0016 0016 0016 0016 0016 003F 0016 003F 0016 0016 0016 0016 0016 0016 0016 0016 0016 0016 0016 0016 0016 0016 003F 0016 003F 0016 0016 0016 0016 0016 0016 003F 0016 003F 0016 003F 0016 003F 0016 0016 0016 0016 003F 0016 003F 0016 003F 0016 0689
2.0ch Audio	OX0A	0000 006D 0000 0022 0157 00AC 0016 0016 0016 0016 0016 0016 0016 0016 003F 0016 003F 0016 0016 0016 0016 0016 0016 0016 0016 0016 0016 0016 0016 0016 0016 003F 0016 003F 0016 0016 0016 0016 0016 0016 003F 0016 003F 0016 003F 0016 003F 0016 0016 0016 0016 003F 0016 003F 0016 003F 0016 0689
5.1ch Audio	OX1E	0000 006D 0000 0022 0157 00AC 0016 0016 0016 0016 0016 0016 0016 0016 003F 0016 003F 0016 0016 0016 0016 0016 0016 0016 0016 0016 0016 0016 0016 0016 0016 003F 0016 003F 0016 0016 0016 0016 0016 0016 003F 0016 003F 0016 003F 0016 003F 0016 0016 0016 0016 003F 0016 003F 0016 003F 0016 0689
7.1ch Audio	OX0E	0000 006D 0000 0022 0157 00AC 0016 0016 0016 0016 0016 0016 0016 0016 003F 0016 003F 0016 0016 0016 0016 0016 0016 0016 0016 0016 0016 0016 0016 0016 0016 003F 0016 003F 0016 0016 0016 0016 0016 0016 003F 0016 003F 0016 003F 0016 003F 0016 0016 0016 0016 003F 0016 003F 0016 003F 0016 0689
Copy EDID	OX1A	0000 006D 0000 0022 0157 00AC 0016 0016 0016 0016 0016 0016 0016 0016 003F 0016 003F 0016 0016 0016 0016 0016 0016 0016 0016 0016 0016 0016 0016 0016 0016 003F 0016 003F 0016 0016 0016 0016 0016 0016 003F 0016 003F 0016 003F 0016 003F 0016 0016 0016 0016 003F 0016 003F 0016 003F 0016 0689
User 1	OX53	0000 006D 0000 0022 0157 00AC 0016 0016 0016 0016 0016 0016 0016 0016 003F 0016 003F 0016 0016 0016 0016 0016 0016 0016 0016 0016 0016 0016 0016 0016 0016 003F 0016 003F 0016 0016 0016 0016 0016 0016 003F 0016 003F 0016 003F 0016 003F 0016 0016 0016 0016 003F 0016 003F 0016 003F 0016 0689

COMMAND	NEC	HEX
User 2	OX52	0000 006D 0000 0022 0157 00AC 0016 0016 0016 0016 0016 0016 0016 0016 003F 0016 003F 0016 0016 0016 0016 0016 0016 0016 0016 0016 0016 0016 0016 0016 0016 003F 0016 003F 0016 0016 0016 0016 0016 0016 003F 0016 003F 0016 003F 0016 003F 0016 0016 0016 0016 003F 0016 003F 0016 003F 0016 0689
User 3	OX01	0000 006D 0000 0022 0157 00AC 0016 0016 0016 0016 0016 0016 0016 0016 003F 0016 003F 0016 0016 0016 0016 0016 0016 0016 0016 0016 0016 0016 0016 0016 0016 003F 0016 003F 0016 0016 0016 0016 0016 0016 003F 0016 003F 0016 003F 0016 003F 0016 0016 0016 0016 003F 0016 003F 0016 003F 0016 0689
User 4	OX45	0000 006D 0000 0022 0157 00AC 0016 0016 0016 0016 0016 0016 0016 0016 003F 0016 003F 0016 0016 0016 0016 0016 0016 0016 0016 0016 0016 0016 0016 0016 0016 003F 0016 003F 0016 0016 0016 0016 0016 0016 003F 0016 003F 0016 003F 0016 003F 0016 0016 0016 0016 003F 0016 003F 0016 003F 0016 0689

RS-232 and Telnet Commands

NO.	COMAND	ACTION
1	?	Print Help Information
2	HELP	Print Help Information
3	STATUS	Print System Status And Port Status
4	PON	Power On, System Run On Normal State
5	POFF	Power Off, System Run On Power Save State
6	IR ON/OFF	Set System IR Control On Or Off
7	KEY ON/OFF	Set System KEY Control On Or Off
8	APM ON/OFF	Set Advanced Process Mode On Or Off
9	BEEP ON/OFF	Set Onboard Beep On Or Off
10	RESET RESET ALL	Reset System To Default Setting (Should Type "Yes" To Confirm, "No" To Discard) Reset System And Network To Default Setting
11	MXIR xx FR yy Output Port IR:xx From Local IR:yy	xx=[00]: All Output IR, [01...08]: Output IR yy=[01...08] Local IR
12	MXIR GI (+-) xx Global IR_IN Signal To Input/ Output IR:xx	xx=[01...08]: Input IR, [09...16]: Local IR xx=[17...24]: Output IR +: Add xx To Current Setting -: Remove xx From Current Setting
13	MXIR GO (+-)xx Global IR_OUT Signal From Input/Output IR:xx	xx=[01...08]: Input IR, [09...16]: Local IR xx=[17...24]: Output IR, [25]: Global IR In +: Add xx To Current Setting -: Remove xx From Current Setting
14	MXRS-232 xx TO yy Local RS- 232:xx Connect To Input/Output RS-232:yy	xx=[01...08]: Local RS-232, [09]: Global RS-232 yy=[00]: Disconnect With Any RS-232 yy=[01...08]: Input RS-232, [09...16]: Output RS-232
15	MXSTA	Print Matrix IR And RS-232 Connect State
16	AUD OUT xx ANA yy	Output Port:xx Audio From Input Port:yy Stereo

NO.	COMAND	ACTION
17	AUD OUT xx EXT yy	Output Port:xx Audio From Input Port:yy Extract xx=[00]: All Output Audio, [01...08]: Output Audio yy=[01...08]: Input Port Audio
18	AUD OUT xx ARC tt	Output Port:xx Audio From Output Port:tt ARC xx=[00]: All Output Audio, [01...08]: Output Audio yy=[01...08]: Input Port Audio
19	AUD OUT xx FOANA	Output Port:xx Audio From Select Video Input Stereo xx=[00]: All Output Audio, [01...08]: Output Audio
20	AUD OUT xx FOEXT	Output Port:xx Audio From Select Video Extract xx=[00]: All Output Audio, [01...08]: Output Audio
21	AUD OUT xx DL zz	Set AUDIO:xx Delay zz ms zz=00 ~ 500ms Delay, 50ms per Step
22	AUD STA	Print Input/Output Port Audio Setting State
23	AUD IN xx ORG	Input Port:xx Use Original Receive HDMI/DVI Signal
23	AUD IN xx BPS	Input Port:xx Bypass Receive HDMI/DVI Signal
24	AUD IN xx ANA	Input Port:xx Insert Stereo To HDMI/DVI Signal
25	AUD IN xx AUTO	Input Port:xx Insert Stereo To DVI Signal Only xx==[00]: All Input Port, [01...08]: Input Port
26	IN xx FO yy	INPUT:xx Force Select Source:yy, Stop Auto
27	IN xx AU yy	INPUT:xx Auto Detect Source, Source:yy High Priority xx=[00]: All INPUT Port, [01...08]: INPUT Port yy=[01]: HDMI, [02]: HDBT
28	OUT xx ON/OFF	Set OUTPUT:xx On Or Off
29	OUT xx FR yy	Set OUTPUT:xx From INPUT:yy
30	OUT xx EH/ET	Set OUTPUT:xx Use HDMI/HDBT EDID xx=[00]: All OUTPUT Port, [01...08]: OUTPUT Port yy=[01...08]: INPUT Port

COMMAND	ACTION
EDID xx CP yy	Set Input:xx EDID Copy From Output:yy
EDID xx DF zz	Set Input:xx EDID To Default EDID:zz xx=[00]: All INPUT Port, [01...06]: INPUT Port yy=[01...06]: OUTPUT Port zz=00: HDMI 1080p@60Hz, Audio 2CH PCM zz=01: HDMI 1080p@60Hz, Audio 5.1CH DTS/DOLBY zz=02: HDMI 1080p@60Hz, Audio 7.1CH DTS/DOLBY/HD zz=03: HDMI 1080i@60Hz, Audio 2CH PCM zz=04: HDMI 1080i@60Hz, Audio 5.1CH DTS/DOLBY zz=05: HDMI 1080i@60Hz, Audio 7.1CH DTS/DOLBY/HD zz=06: HDMI 1080p@60Hz/3D, Audio 2CH PCM zz=07: HDMI 1080p@60Hz/3D, Audio 5.1CH DTS/DOLBY zz=08: HDMI 1080p@60Hz/3D, Audio 7.1CH DTS/DOLBY/HD zz=09: HDMI 4K@30Hz 4:4:4, Audio 2CH PCM zz=10: HDMI 4K@30Hz 4:4:4, Audio 5.1CH DTS/DOLBY zz=11: HDMI 4K@30Hz 4:4:4, Audio 7.1CH DTS/DOLBY/HD zz=12: DVI 1280x1024@60Hz, Audio None zz=13: DVI 1920x1080@60Hz, Audio None zz=14: DVI 1920x1200@60Hz, Audio None zz=15: User EDID 1 zz=16: User EDID 2 zz=17: GUI Download EDID zz=18: HDMI 4K@60Hz 4:2:0, Audio 2CH PCM zz=19: HDMI 4K@60Hz 4:2:0, Audio 5.1CH DTS/DOLBY zz=20: HDMI 4K@60Hz 4:2:0, Audio 7.1CH DTS/DOLBY/HD
MUTE ON/OFF OUT yy	Set Output Audio: yy Mute On or Off
VOL xx OUT yy	Set Output Audio:yy Volume to xx yy=[00]: All Output Audio, [01...06]: Output Audio xx=[00...30]: Volume Value xx=+: Volume Increase xx=-: Volume Decrease
NET DHCP ON/OFF :	Set Auto IP(DHCP) ON Or OFF
NET IP xxx.xxx.xxx.xxx :	Set IP Address
NET GW xxx.xxx.xxx.xxx :	Set Gateway Address
NET SM xxx.xxx.xxx.xxx :	Set Subnet Mask Address
NET RB :	Set Network Reboot and Apply New Config!!!
NET TN xxxx :	Set Telnet Port

Certifications

FCC Notice

This equipment has been tested and found to comply with the limits for a Class B digital device, pursuant to part 15 of the FCC Rules. These limits are designed to provide reasonable protection against harmful interference in a residential installation. This equipment generates, uses, and can radiate radio frequency energy and, if not installed and used in accordance with the instructions, may cause harmful interference to radio communications. However, there is no guarantee that interference will not occur in a particular installation. If this equipment does cause harmful interference to radio or television reception, which can be determined by turning the equipment off and on, the user is encouraged to try to correct the interference by one or more of the following measures:

- Reorient or relocate the receiving antenna.
- Increase the separation between the equipment and receiver.
- Connect the equipment into an outlet on a circuit different from that to which the receiver is connected.
- Consult the dealer or an experienced radio/TV technician for help.

CAUTION - changes or modifications not expressly approved by the party responsible for compliance could void the user's authority to operate the equipment.

CANADA, INDUSTRY CANADA (IC) NOTICES

This Class B digital apparatus complies with Canadian ICES-003.

Operation is subject to the following two conditions: (1) this device may not cause interference, and (2) this device must accept any interference, including interference that may cause undesired operation of the device.

CANADA, AVIS D'INDUSTRY CANADA (IC)

Cet appareil numérique de classe B est conforme aux normes canadiennes ICES-003.

Son fonctionnement est soumis aux deux conditions suivantes : (1) cet appareil ne doit pas causer d'interférence et (2) cet appareil doit accepter toute interférence, notamment les interférences qui peuvent affecter son fonctionnement.

CORRECT DISPOSAL OF THIS PRODUCT

This marking indicates that this product should not be disposed with other household wastes. To prevent possible harm to the environment or human health from uncontrolled waste disposal, recycle it responsibly to promote the sustainable reuse of material resources. To return your used device, please use the return and collection systems or contact the retailer where the product was purchased. They can take this product for environmentally safe recycling.





Notes





Notes





ELAN[®]



main:
1 (800) 472-5555 - US
1 (707) 283-5900 - International
1 (707) 283-5901 - Fax

tech support:
techsupport@elanhomesystems.com

web:
elanhomesystems.com

