

CN-1800S Instructions

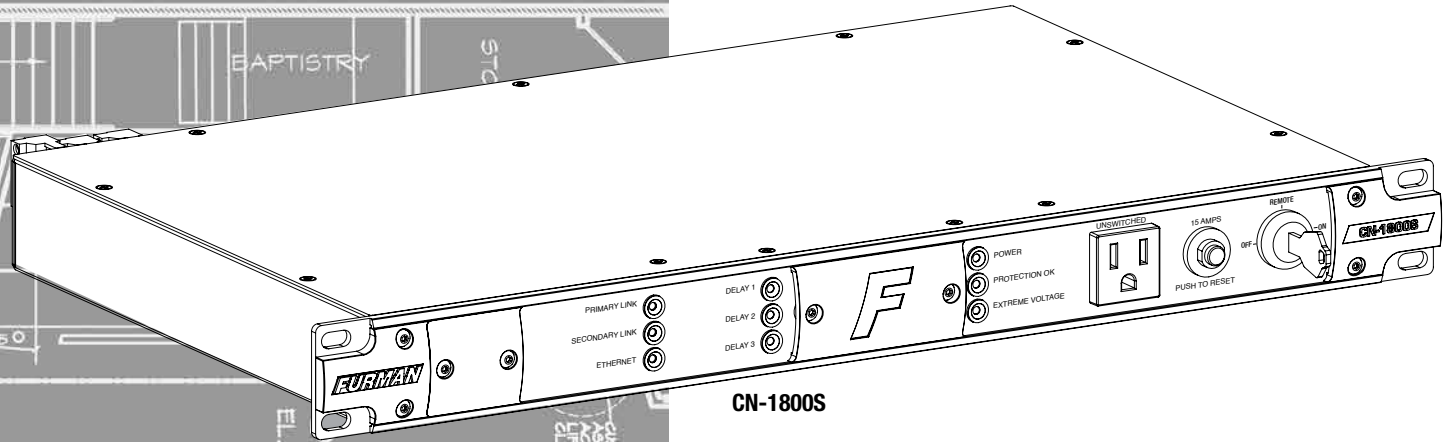
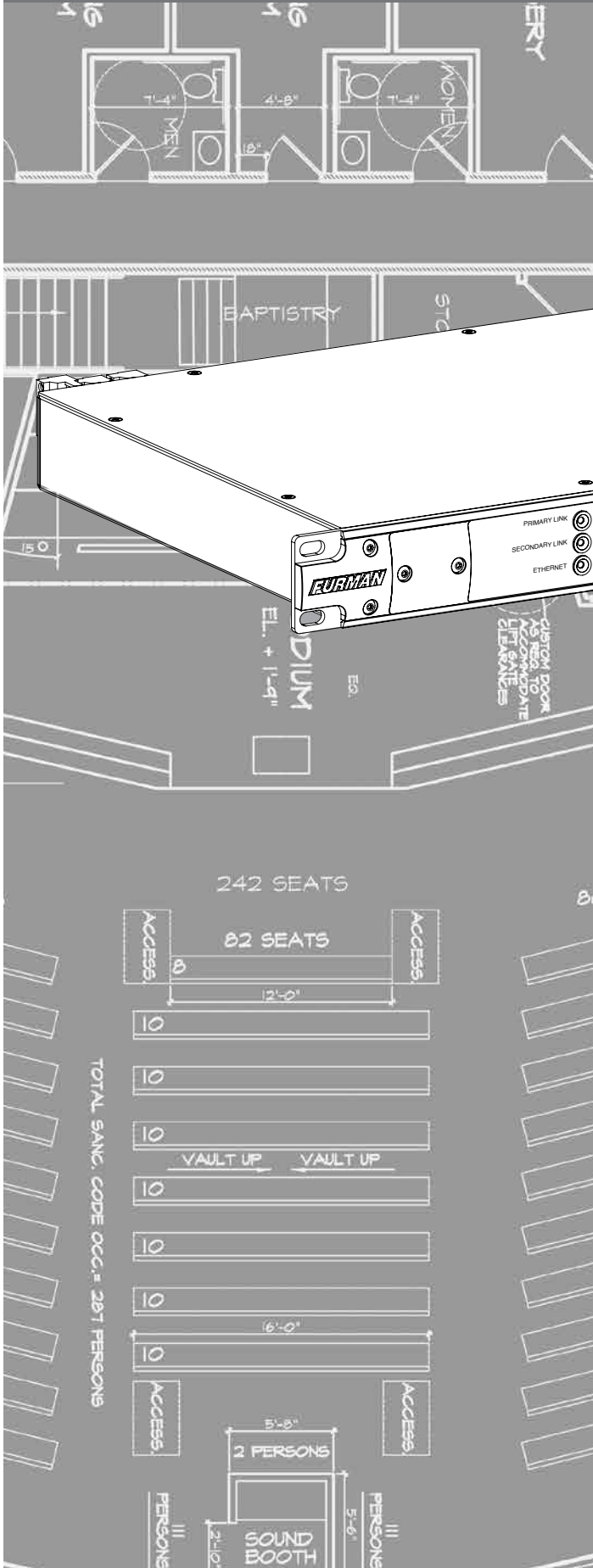

CN-1800S

Contractor Grade Power Management with SmartSequencing™

Features:

SmartSequencing™ technology allows large complex A/V systems to be safely power cycled on and off sequentially, with a simple key turn or press of a button.

Series Multi-Stage Protection (SMP) ensures zero downtime for mission critical installations by safely eliminating dangerous surges and spikes.

Extreme Voltage Shutdown (EVS) with auto reset safeguards against operation during catastrophic under and over voltage conditions.

Linear Filtering Technology (LiFT) ensures maximum equipment performance by reducing AC noise in a linear fashion across a wide bandwidth.

Remote Access (RS-232) compatibility with programming provides integration with various control system platforms, including BlueBOLT®.

Security features include a key switch to prevent unauthorized operation and cover shields to prevent tampering with switch settings.

Forced Off immediate shutdown: for safety and fire ordinance compliance. Multi-Color LED Indicators for status functions.

9 outlets on 4 banks providing 1800 total Watts of conditioned AC power.

10 ft. Power Cord 14 AWG

15 Year Limited Product Warranty

Introduction

Congratulations and thank you for choosing the Furman CN-1800S. We assure you that your CN-1800S will provide many years of trouble free operation. The CN-1800S is a 15 Amp Contractor-Grade Surge Protector and Power Sequencing device equipped with Furman's exclusive SmartSequencing™ technology. The Furman CN-1800S features multiple layers of protection that have been designed to shield your sensitive analog and digital equipment from AC line hazards. Furman's SmartSequencing™ technology defines a new level of power management and control while streamlining installations from start to finish.

Why choose Furman?

At Furman Sound, we have spent the last 30 years quietly obsessing about professional audio and how to best separate your equipment from the noise and damage often associated with AC power. Over the years we have developed a multitude of technologies that have spared countless devices from certain death and earned us the trust and respect of the Professional A/V industry. The CN-1800S represents the culmination of our engineering expertise and leverages more than 30 years of experience.

Why choose AC power sequencing?

Many pro audio/video installations need audio power amplifiers to activate last. Our solution is the AC power sequencer. The power sequencer provides AC power to outlet groups one at a time, thus allowing equipment to be powered up and down in an orderly fashion by first providing power to signal processing equipment and then providing power to the amplifiers. When shutting down the A/V system, a sequencer will turn off the system in the reverse order, hence the amps will be turned off first, and then the signal processing equipment will be turned off last.

This is necessary because, as most sound reinforcement professionals know, the majority of equipment damage occurs when devices are either powered up or powered down. Power sequencing allows equipment to power up in sequence and prevent the dreaded "pop". The "pop" is a speaker pop associated with on/off switching of signal processing equipment while the audio power amplifiers are energized. If the signal processing "pop" is amplified sufficiently, the result can damage speaker components. Because it prevents this unwanted, and often costly, circumstance, AC power sequencing is extremely valuable.

Furman Contractor Series equipment also allows sound reinforcement equipment to be remotely powered up or powered down over a large distance, not just in the immediate vicinity of the operator. Additionally, Maintained or Momentary mode contact switching allows the user great flexibility when controlling the unit from a remote location. A remotely mounted switch or control pad can be used to sequence equipment on or off. In addition, Furman Contractor Series remote functions can be initiated across a room, on-site, or off-site with RS-232 protocol or our cloud-based BlueBOLT technology.

The CN-1800S **SmartSequencer** incorporates Furman's revolutionary Series Multi-Stage Protection (SMP) circuit with our acclaimed Linear Filtering Technology (LiFT). In combination, these field tested technologies comprise, without question, the world's most advanced power conditioning and transient voltage surge suppression anywhere! And, in regards to Professional A/V, the CN-1800S fulfills many power sequencing requirements that have not been easy to achieve in the past. Furman SmartSequencing™ delivers right out of the box! Please review this manual thoroughly to discover how the CN1800S with SmartSequencing™ delivers professional results.

Before You Begin Inspect Upon Receipt

The box should contain the following items: a Contractor Series Quick Start Guide

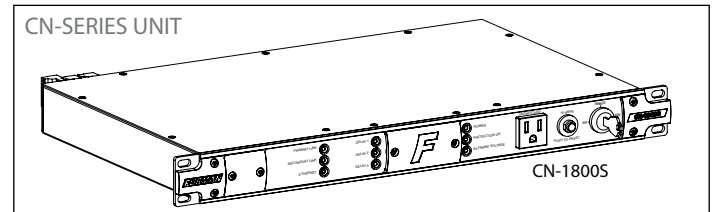

CN-1800S

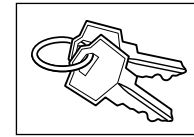

Pair of Security Keys

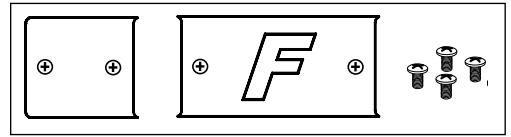

Two Removable Cover Shields and Four Screws

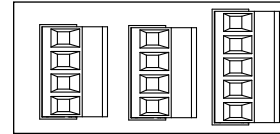

3 Phoenix Type Connectors
(2 four pin, 1 five pin)

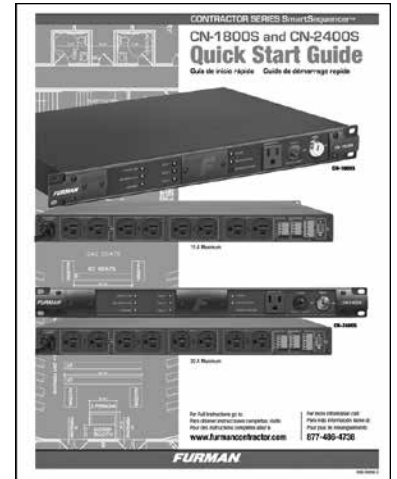

Quick Start Guide

Table of Contents

Feature Descriptions	2 & 3
Important Safety Instructions	3
Quick Start Diagrams	4 & 5
SmartSequencing™ 101	6
Front Panel Overview	6, 7, 8, 9, 10 & 11
Rear Panel Overview	12 & 13
Setup and Troubleshooting	13
RS-232 Installation and Command Set	14
BlueBOLT™	14
Specifications	14
FCC Notice and Customer Service	14
15 Year Limited Warranty	14

SmartSequencing™

Furman SmartSequencing™ is a contractor-friendly technology that makes AC power sequencing easy to employ by non-technical personnel. Multiple Furman Contactor Series units can be linked together using inexpensive two conductor wire, thus creating a vast control system. Generally, high-priced automation systems are used for large, innovative installs, yet these control systems seldom combine AC power distribution, filtering, and protection. Furthermore, many automation systems are difficult to implement on smaller budgets. SmartSequencing™ provides the answer right out of the box by offering a simple approach to AC power management and control. Furman's newest power sequencing technology is an end-to-end solution that is operational up to 1000 feet via a non-polarized, isolated current loop. In situations where power sequencing is critical, or more than one AC electrical circuit is utilized, wiring Furman SmartSequencing™ products in series is simple, fast and reliable.

SMP (Series Multi-Stage Protection)

Furman's SMP surge suppression virtually eliminates service calls and costly "down time". Traditional surge suppression circuits sacrifice themselves when exposed to multiple transient voltage spikes, requiring your system to be dismantled and your surge suppresser to be repaired. This does not happen with Furman's SMP. Damaging transient voltages are safely absorbed, clamped, and dissipated. Your connected equipment is protected, while your Furman protects itself! Its unparalleled clamping voltage is unique to Furman's SMP. According to UL 1449 Clamping Level is defined as the amount of voltage that is allowed to pass through to your equipment when the protection device is subjected to a transient surge or spike. While other designs offer clamping voltages that clamp well above 330 Vpk, Furman's SMP clamps at 188 Vpk, (133 VAC RMS) even when tested with multiple 6000 Vpk - 3000 Amp surges. This unprecedented level of protection is only available with Furman's SMP technology!

EVS (EXTREME VOLTAGE SHUTDOWN)

Furman's trusted (EVS) over-voltage circuitry protects against prolonged over-voltage conditions, such as accidental connections to 208 or 240 VAC or an intermittent loss of neutral. It does so by monitoring the incoming AC voltage. When an unsafe condition is detected, a relay shuts off the incoming power until the overvoltage condition has been corrected. The CN-1800S augments the EVS capability with Auto Reset options allowing the end user to decide if the power should be reinstated, or remain off until conditions return to acceptable limits. The Extreme Voltage Shutdown technology is a tremendous asset.

LIFT (LINEAR FILTERING TECHNOLOGY)

Unfortunately, traditional AC power conditioners have been designed under unrealistic laboratory conditions. Professional audio/video components are constantly bombarded by electromagnetic interference (EMI) and radio frequency interference (RFI) via their AC power source. Prior technologies, whether they were multiple-pole or conventional series-mode filters, could actually harm audio and video performance more than they help, due to the resonant peaking of their antiquated, non-linear designs. Under certain conditions, these designs can actually add more than 10 dB of noise to the incoming AC line! Worse still, AC noise and ground contamination frequently causes system reboots, sync issues and even data loss. LIFT takes a different approach, ensuring optimal performance through Furman's linear AC noise filtering with no ground contamination.

Remote Access (and BlueBOLT®)

If so desired, the CN-1800S can be controlled remotely via an integral RS-232 data-link and command protocol. The remote access feature delivers integration with various control systems. The protocol set provides over a dozen commands such as reset, disable, and sequence and includes queries such as voltage, current, and power. Our optional BlueBOLT® RS-232-to-Ethernet adaptor (available Q4, 2012) provides additional control programming and monitoring from any Web-enabled device via Telnet, direct HTTP connection, or www.mybluebolt.com

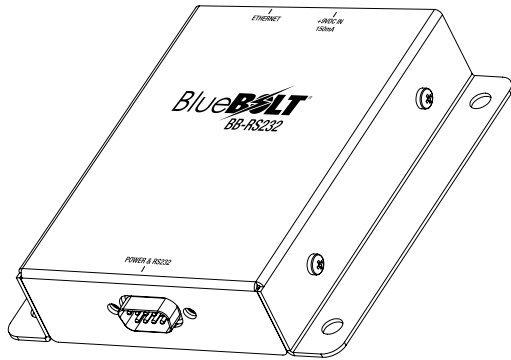

Security and Safety

The CN1800S is adaptable to most common installation requests and requirements. An ON/OFF key switch prevents operation from unauthorized personnel and removable security covers help to discourage tampering. The RS-232 DE-9 communications port can be defeated by the key switch. Furthermore, there are Forced Off inputs and selectable DIP Switch settings for connecting to alarm systems, thus providing an immediate power shutdown in compliance with many fire ordinances. The combinations of features cover many needs for a wide variety of client concerns.

Additional Features

The CN1800S Power Sequencer is equipped with eight 120V rear panel outlets on four duplexes and a single front panel convenience outlet, all filtered and protected with Furman technology. The unit has three unswitched outlets that provide constant power under safe utility conditions. Rear panel outlets are divided into four banks: one bank with two unswitched outlets and three banks are sequenced at two outlets per bank. A related dry contact is coupled with the "Delay Bank 3" bank; together both can offer a delay up to seven minutes. Features also include 10 LED indicators to aid in tracking conditions such as power, protection, sequencing and communication. And naturally, the CN-1800S Contractor Series 1800 Watt 15 Amp capacity is supplied by a robust 14 AWG, 10 foot AC cord.

All Contractor Series units and features are backed by a 15 year Limited Warranty.

Important Safety Instructions

1. Please read and follow all instructions.
2. Please keep these instructions.
3. Please heed all warnings.
4. **WARNING:** This device is intended for indoor use only. Do not use this device near water. To Reduce the risk of fire or electric shock, do not expose this device to rain or moisture.
5. **CAUTION:** Always On receptacles are present, providing constant AC power. To Reduce risk of shock, please disconnect the CN-1800S / CN-2400S Sequencer from AC power before servicing any equipment connected to the CN-1800S / CN-2400S Sequencer.
6. Clean only with dry cloth.
7. **CAUTION:** Do not install near any heat sources such as radiators, heat registers, stoves, or other equipment that may produce heat.
8. Protect the power cord from being walked on or pinched, particularly at plugs, convenience receptacles, and the point where they exit the device.
9. **WARNING:** The DB-9 RS-232 communications port provides power for Furman accessories (e.g. BB-RS232). Please verify pin assignment and protocol before connecting any other manufacturer's device to this port.
10. Please, only use accessories specified by the manufacturer.
11. Refer all servicing to qualified personnel. Servicing is required when the unit has been damaged in anyway or fails to operate.
12. **WARNING:** Do not use power cord as the main power disconnect. The device is intended for AC power sequencing.
13. Do not defeat the safety purpose of the polarized plug. A polarized plug has two blades, with one wider than the other. The wide blade is provided for your safety. If the provided plug does not fit into your outlet, consult an electrician for replacement of the obsolete outlet.
14. Do not defeat the safety purpose of the grounding prong. A ground type plug has two blades and a third grounding prong. The third prong is provided for your safety. If the provided plug does not fit into your outlet, consult an electrician for replacement of the obsolete outlet.
15. **WARNING:** This device must be connected to an AC outlet with a protective earth ground connection.

EXAMPLE 1 DIAGRAM - SMALL SmartSequencing SET-UP

RS-2 Momentary Remote Switch

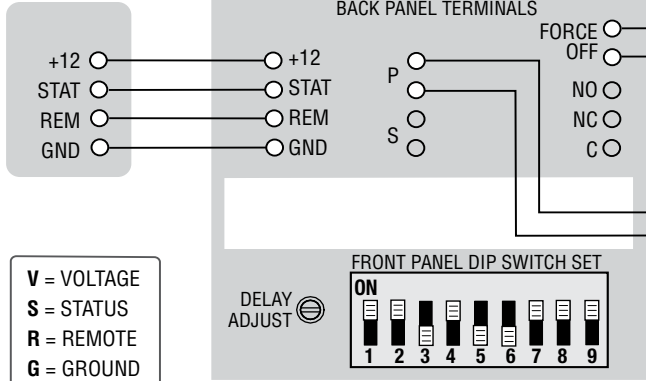

V = VOLTAGE
S = STATUS
R = REMOTE
G = GROUND
D = DELAY

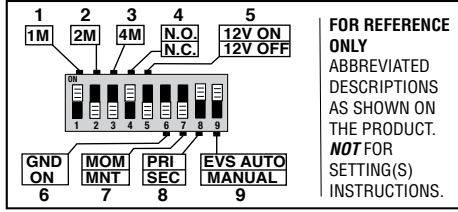

CLASS 2 WIRING
24 AWG RECOMMENDED

Fire ordinances sometime require immediate shut down, no matter how large or small a sound system. SmartSequencing provides the solution.

FIRE ALARM (2 POLE)
IMMEDIATE FORCED OFF WITH SHORT

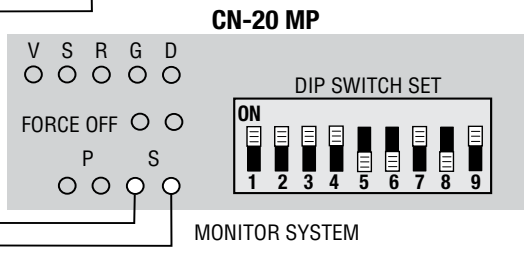
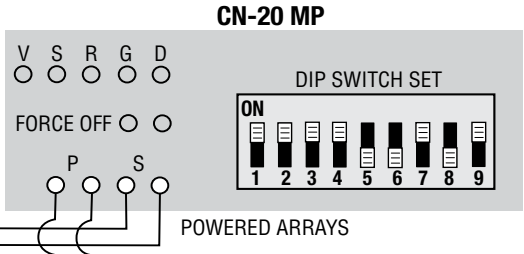

EXAMPLE 2 DIAGRAM - SMALL LEGACY SET-UP

RS-1 Maintained Key Switch

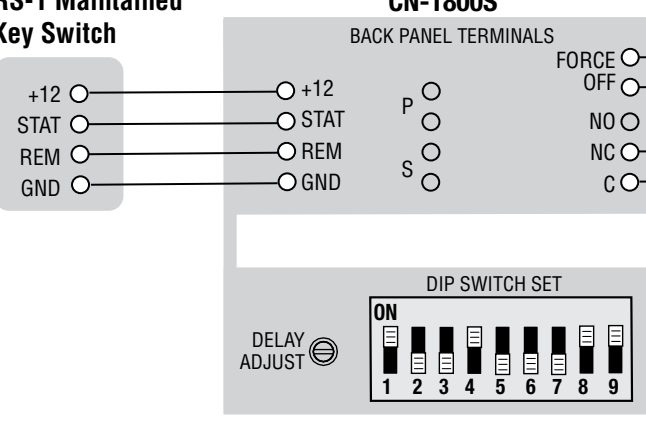

CLASS 2 WIRING
24 AWG RECOMMENDED

CN-1800 replaces Legacy product for purposes of immediate shutdown.

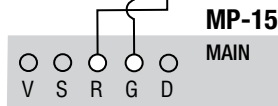
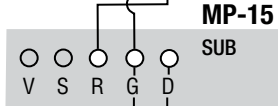
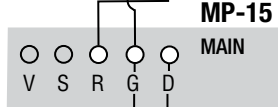
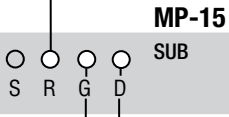

NC C NO

FIRE ALARM (3 POLE)

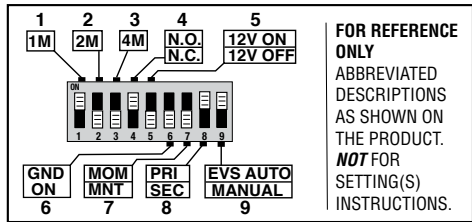

EXAMPLE 3 DIAGRAM - LARGE LEGACY UPGRADE

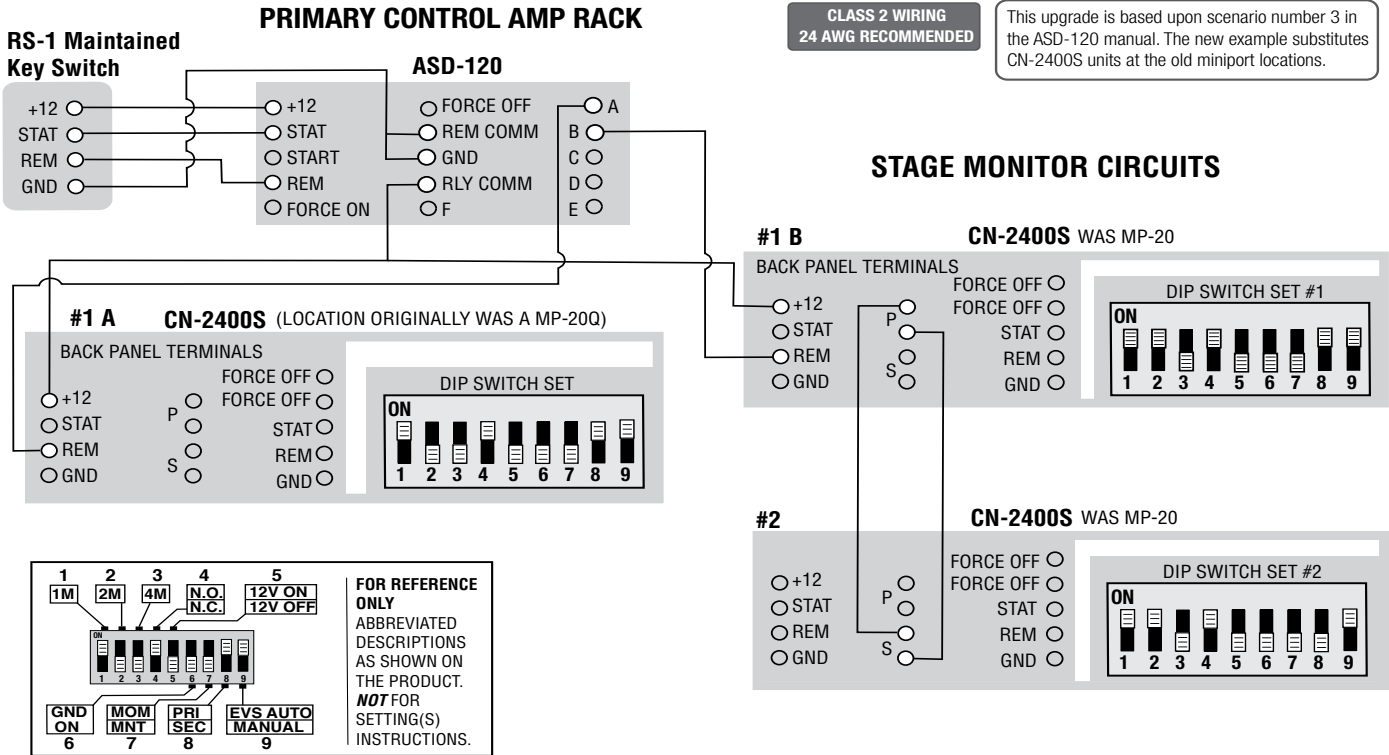

EXAMPLE 4 DIAGRAM - LARGE SET-UP PRIMARY CONTROLLED VIA RS-232

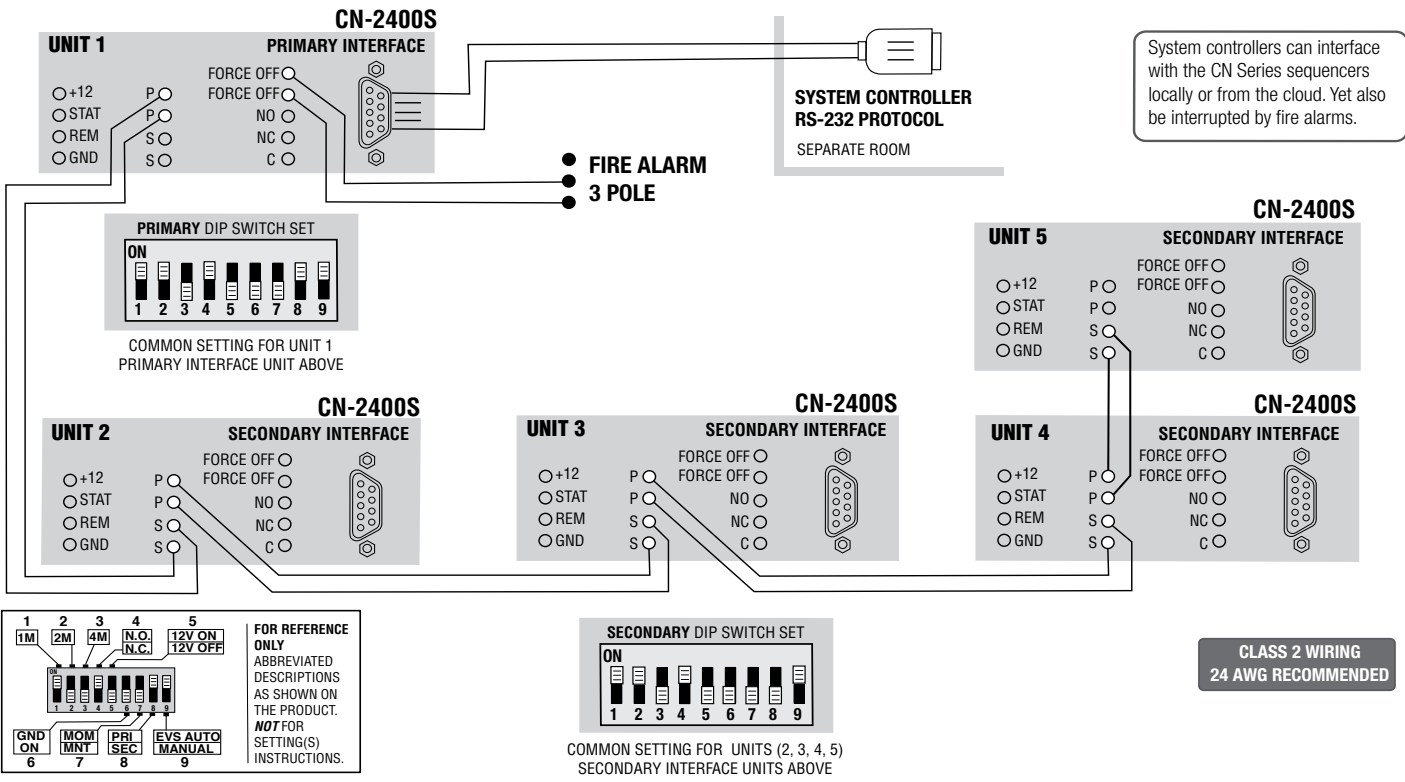

SmartSequencing™ 101

Note: A pair of wires between the **Primary OUT** terminals of one sequencer and the **Secondary IN** terminals of a second sequencer is all that is required. Which terminals are used at the **IN** port or the **OUT** port does NOT matter; the wiring scheme is polarity independent. Please remember, even non-technical personnel can achieve professional results with SmartSequencing™. Two wire runs connecting two or more units create a SmartSequencing chain.



Furman SmartSequencing™ products can be connected end-to-end to form a chain. Each Contractor Series unit has two communication ports (OUT and IN) divided into 4 terminals, responsible for full-duplex transmissions via two bi-directional current loops. The messages communicated are in the form of ASCII character strings made more efficient by utilizing a High-Level Data Link Control. The first SmartSequencer in a chain is termed the “Primary” or “Primary Unit”; it controls the “other sequencers” in the chain. The “other sequencers” are termed “Secondary” or “Secondary Units”. The Primary Unit only has one active current loop, because the Primary Unit only has one Secondary sequencer attached to it. Once again, when sequencers are attached with SmartSequencing, the first sequencer in the chain is termed the Primary Unit and all the subsequent sequencers in the chain are termed Secondary Units. And so the chain continues as additional Secondary Units are attached, OUT to IN, OUT to IN, OUT to IN, etc. A pair of wires between the Primary OUT terminals and the Secondary IN terminals is all that is required to create a continuous SmartSequencing chain.

A Furman SmartSequencing™ chain transmits a message as follows: A Primary Unit communicates to the first Secondary Unit downstream, by sending commands out of its Primary OUT terminals to the Secondary IN terminals of the first Secondary Unit. If there is a second Secondary Unit in the chain, the first Secondary Unit communicates to the second Secondary Unit, using its Primary OUT terminals to the second Secondary Unit’s Secondary IN terminals. This continues down the sequence chain until the last Secondary Unit. The last Secondary Unit will receive commands into its Secondary IN terminal port but will not use its Primary OUT terminal port (because there are no Secondary Units after it). Please see figure to the left:

SmartSequencing™ commands between units are always accepted when continuity exists, however SmartSequencing commands that control the outlets are not always allowed. There are two considerations for deciding whether SmartSequencing control commands are allowed: one, the state of the other CN-1800S functions (i.e: Key Switch, Start Sequence Push Button, and Remote terminals e.g. Force Off); and two, whether the Sequencer is configured as a Primary or a Secondary unit.

The Primary Unit has an active DE-9 RS-232 port that can be used to communicate with a local RS-232 control system or an Ethernet Blue-BOLT adaptor. When a SmartSequencer is selected as a Secondary Unit (DIP Switch position 8 is DOWN or OFF), the unit’s RS-232 port is deactivated. The Key Switch and Force Off function will also defeat the RS-232 port functions regardless of the units Primary or Secondary status.

Additional SmartSequencing™ information is available throughout this instruction manual. More information on SmartSequencing™ can be found at our contractor website www.furmancontractor.com. Details such as firmware updates, Quick Start diagrams, etc., can also be found at the website.

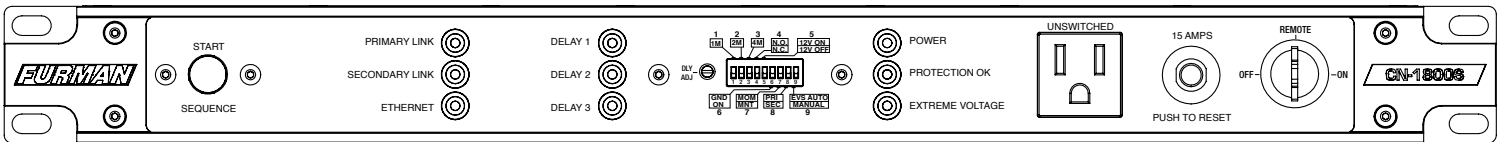

Front Panel Overview

Start Sequence Push Button

The Start Sequence button can be used for sequencing power up or power down. This button is located at the left side of the panel. The START SEQUENCE pushbutton is there to initiate local operation when the key switch is set to REMOTE. Please note, setting the key switch to ON defeats operation of the START SEQUENCE pushbutton, keeping in mind that both the key switch and the START SEQUENCE button operate in either Maintained or Momentary mode (DIP Switch position 7). If a number of units are linked via SmartSequencing, or via Remote Terminal, and unit drops out of sync, press and hold the START SEQUENCE button for several seconds; this will initiate a re-sync.

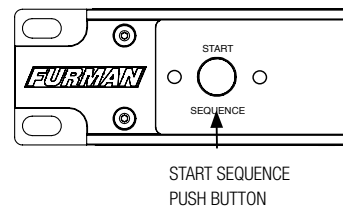

START SEQUENCE PUSH BUTTON

Triggers sequence in remote mode.

- Activates or deactivates sequence
- Hold button to re-sync multiple sequencers

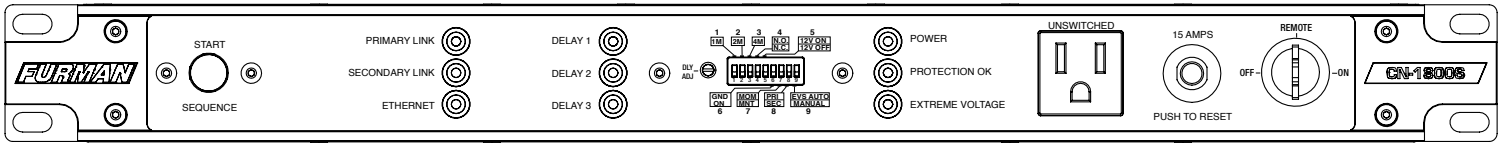

Connection Status Lights

Each multi-color Connection Status Light provides information on the CN-1800S' communication links. There are three LEDs, labeled PRIMARY and SECONDARY LINK and ETHERNET that make up the Connection Status Light subsystem. The top two LEDs are associated with the SmartSequencer link system and can illuminate Red, Green, or Amber. The Bottom LED, labeled ETHERNET, indicates the status of a remote connection. When a number of CN-1800S are connected together via their SmartSequencer link ports, the top two LEDs will illuminate Green and occasionally blink as messages are passed between units. The ETHERNET LED will illuminate Green when the CN-1800S is communicating with an RS232 to BlueBolt adapter.

SmartSequencing Note: When there are two or more SmartSequencer units chained in series, a slowly blinking Green Primary Link LED interval identifies the Primary Unit. Furthermore, a SmartSequencer displaying a solid Green Primary Link LED would indicate the unit is the last Secondary in the chain. Secondary Units in the middle of the chain will display both a solid Green Primary Link LED and a solid Green Secondary Link LED. The Connection Status Link Indicators will flash accordingly during power up and power down and as SmartSequencer messages are sent between units.

Green LED status is a sign of good communications. If a Contractor Series unit is used independently (no connections) and the unit is configured as a Primary Unit (DIP 8, ON or UP), the Primary Link LED will slowly blink Green at 1 second intervals. If there is a SmartSequencer link connecting a Primary Unit to a Secondary Unit, the Primary unit will send messages to the Secondary Unit and the Secondary Link LED will illuminate Green on the Primary Unit, indicating there is an established communication link with a the Secondary Unit. On Secondary units (DIP Switch 8, OFF or DOWN), the Primary Link LED will be Green, indicating there is communi-

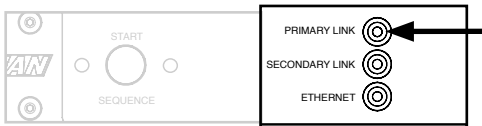

PRIMARY LINK – Multi-color LED indicates the condition of communications between the Secondary Link and the Primary Link of the preceding unit.

GREEN Unit is communicating through Secondary Link to preceding unit's Primary Link OUT.

RED Unit has lost communications through Secondary Link to preceding unit's Primary Link OUT.

Please Note: A slow blinking GREEN PRIMARY LINK LED indicates the unit is configured as the MAIN Primary unit per DIP Switch 8. (Factory default).

Please Note: A SECONDARY DEVICE should have a solid green PRIMARY LINK LED.



SECONDARY LINK – Multi-color LED indicates the condition of communications between the Primary Link and the Secondary Link of the following unit.

GREEN Unit is communicating through Primary Link to following unit's Secondary Link IN.

OFF Unit has lost communications through the Primary Link to following unit's Secondary Link IN.

Please Note: An unlit SECONDARY LINK LED indicates last unit in sequencing chain. A single unit will have an unlit SECONDARY LINK LED.

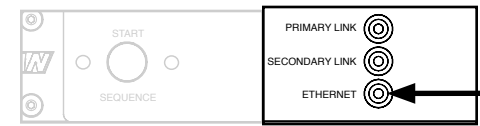

ETHERNET – Color indicates status of link communication with BlueBOLT cloud based platform.

LED OFF Indicates no connection via BlueBOLT adapter (e.g. BB-RS232)

GREEN Indicates the unit has established active communication through BlueBOLT adapter.

Please Note: The port is labeled COMM/POWER and does provide 12VDC to suitable accessories. Baud Rate 19200.

The Red Connection status LED can sometimes illuminate briefly if a message is lost or corrupted on the SmartSequencing link. Unless the Red LED is continuous, this should be no cause for concern. The SmartSequencing protocol is robust and redundant. As long as a physical link is in place, the message will eventually get through.

A continuous Red Connection Status LED indicates that a unit has no SmartSequencing link connection where the unit has been configured to expect link communications. This occurs when a Secondary Unit cannot communicate with surrounding units in a SmartSequencing chain. The result is that the Secondary Units Primary Link LED may be Red because the link is broken to a Primary Unit or the Secondary Link LED may be Red, because the link is broken to a Secondary Unit. This could also mean that the Secondary Unit sees the Primary Unit, but the Primary Unit does not see its Secondary.

The Amber LED may be seen upon start up initialization or as communication ensues between Smart Sequencers. This Amber LED state should resolve to a Red or Green state. If the amber indication does not resolve, please contact Furman Support.

Delay Indicators

One DELAY LED is featured for each rear outlet delay stage. Each LED illuminates Green sequentially as each stage completes, indicating power is available at the corresponding rear panel bank. If the CN-1800S is operating under safe power conditions and no utility fault conditions exist, all three Delay LEDs will remain steadily lit when all outlets ON. Once triggered to power-down, each LED goes off in sequence as its corresponding delay bank is deactivated. Note that the DELAY 3 output and the rear panel DELAY 3 relay contacts are closely associated. When the indicator DELAY 3 LED is illuminated, the DELAY 3, Common (C) and Normally Open (NO) terminals are shorted. When the indicator DELAY 3 LED is off, the DELAY 3, Common (C) and Normally Open (NC) terminals are shorted

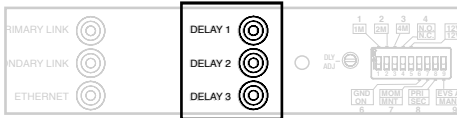

DELAY INDICATORS

DELAY 1 Duplex 1 is powered on

DELAY 2 Duplex 2 is powered on

DELAY 3 Duplex 3 is powered on

Delay 3 contacts react in time with DELAY 3 Outlets

DIP Switch and Delay Adjustment

The DIP Switch is found at the center of the front panel, under the "F" logo Security Cover. You will need to remove the cover by removing the two M3 screws to gain access to the DIP switch. The DIP Switch is used to set various sequencer options. It is also used in combination with the DLY ADJ pot to set range intervals for the SWITCHED banks. The time DIP switch settings are ON in the UP position and OFF in the DOWN position.

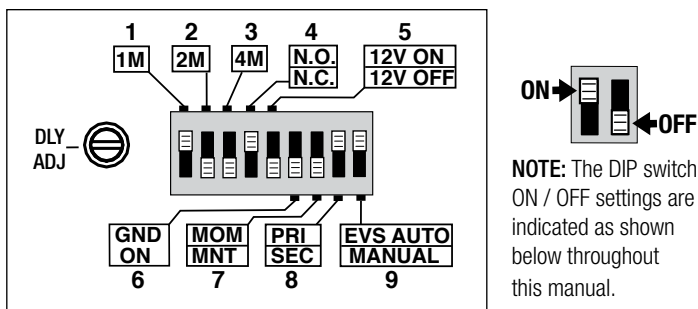

Factory-set DIP Settings:

DIP SWITCH DEFAULT SETTING - Switches are factory pre-set as shown below. Switches **1, 4, 8, and 9** are up (ON) position.

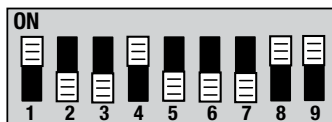

DIP 1, DIP 2, and DIP 3: DIP Time Adjustment

There are three DIP switches assigned to control the time delay interval, DIP switch positions 1, 2, & 3. The time delay, or "dwell time" between consecutive duplexes is the same whether the CN-1800S is sequencing ON or OFF. DIP 1 adds 1 minute to the maximum time delay, DIP 2 adds 2 minutes and DIP 3 adds 4 minutes. Note: These time delays are cumulative. If all three DIP switches are in the UP position, the maximum allowable time delay will be 7minutes, i.e. 1min+2min+4min=7min. The factory default setting is DIP 1 ON or UP, and DIP 2 and 3 are OFF or DOWN. You can set these switches in any position you like to achieve your preferred time delay.

Delay Adjustment

In order to precisely dial in your preferred sequence dwell time, it is necessary to set the Time Delay Adjustment (DLY ADJ) located next to the DIP Switch. If this potentiometer is turned to its 100% value (fully clockwise), then the time delay will be equal to the maximum time delay defined by DIP switches 1, 2, and 3. If the potentiometer is in the 12:00 o'clock position (50%), then the time delay will be 50% of the maximum time delay interval defined by the setting of DIP Switch positions 1, 2 & 3. If all three DIP switches are off, and the potentiometer is turned completely counter-clockwise, the time delay is minimal. The Delay Adjustment potentiometer comes factory-set at 50%, the 12 o'clock position.

Example: If the DIP Switches are set to a 6 minute maximum delay and the potentiometer is set to its 50% setting, then the delay interval between sequenced banks will be 3 minutes. (DIP 1 OFF or DOWN, DIP 2 and DIP 3 ON or UP) x .50 = 6 minutes x .50 = 3 minutes.

DIP 1 1M = 1 Minute Delay

DIP 2 2M = 2 Minute Delay

DIP 3 4M = 4 Minute Delay

NOTE: DIP 1, 2 & 3 can be summed together up to 7 minutes.

DIP 4 N.O. / N.C. sets Forced Off alarm poles

The out of the box factory setting is "normally open". When sequence is "ON". Switched outlets will be ON until a dry contact closure is applied across the FORCE OFF poles.

DIP 5 12VDC ON/OFF sets +12V pole in Remote Mode (DIP 7 set to MNT)

Chooses +12V to REM pole functionality. In default OFF mode, a dry closed contact across +12V to REM triggers sequencer OFF. If ON mode, closed contact triggers ON.

- 12V OFF = Short Deactivates
- 12V ON = Short Activates

DIP 6 GROUND ON / OFF

Activates REM to GND pole functionality.

- REMOTE TO GROUND = ON

DIP 7 Maintained / Momentary

Sets contact closure preference for either **Maintained** or **Momentary** switches. NOTE: Momentary mode overrides DIP 5 and 6.

DIP 8 PRIMARY / SECONDARY

Delegates unit's role in command sequence.

DIP 9 EVS AUTO / MANUAL setting

Activates/Deactivates Extreme Voltage Shutdown Auto Reset. Manual setting requires **Key Switch** to be set **OFF** to clear **EVS** state.

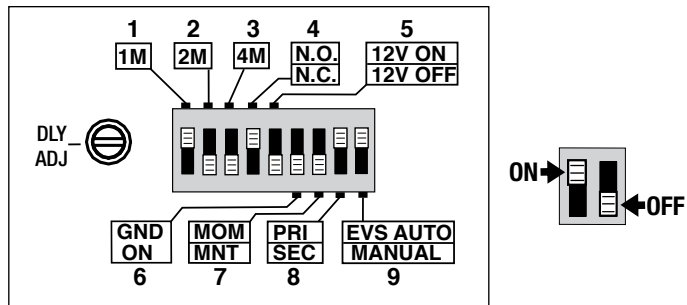

Factory-set DIP Settings:

POTENTIOMETER DEFAULT

SETTING - Time Delay

Adjustment is set at 12:00 o'clock (50%)



Time Delay Adjustment ranges from 0.0% to 100%. The percentage is multiplied with the DIP switch selections 1, 2 and 3.

DIP SWITCH DEFAULT SETTING -

Switches are factory pre-set as shown below. Switches 1, 4, 8, and 9 are up (ON) position.

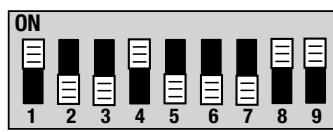

DIP 4, DIP 5, DIP 6, and DIP 7: Remote Mode Trigger Settings

DIP Switch position 4 is used to define how the CN-1800S will implement its FORCE OFF feature. FORCE OFF is a safety feature that is designed to cut AC power to all outlets instantaneously. Many municipalities require this feature as a means of disabling equipment in the presence of fire or alarm. The FORCE OFF inputs are the two uppermost poles on Barrier Strip 3. The FORCE OFF inputs can be used with a momentary or maintained dry contact in either a Normally Open or Normally Closed state. The factory default position is DIP 4 ON or UP, or (NO) Normally Open. In this configuration, the FORCE OFF will be triggered when the FORCE OFF pins are shorted. If DIP Switch position #4 is on (DIP 4 Off or DOWN) the FORCE OFF pins must remain shorted for normal operation. In this configuration, the FORCE OFF will be triggered when the short between the FORCE OFF pins is removed.

If a FORCE OFF occurs, the power to all outputs will be immediately disabled and the DELAY LEDs will blink together. To recover from a FORCE OFF condition, the CN-1800S or all units in the sequencing chain must be sequenced off locally, via the Key Switch or Start Sequence pushbutton. Once reset, operations will resume normally. DIP 4 has priority over

DIP 5, DIP 6, and DIP 7 settings. Information found under the following sections DIP 5, DIP 6, and DIP 7 explain typical remote switch operations. The use of DIP 4 may or may not be a consideration at every install, yet it may be vital with regards to safety compliance. The FORCE OFF feature is always active, despite the fact sometimes it is in a forgotten state of operation. And again, the DIP 4 factory-set position is Up, or (NO) Normally Open; in order not to disrupt other sequencer functions when emergency systems are not required.

DIP 5 (+12V, ON OFF) and **DIP 6** (GND ON) are used in special situations, where the standard Contractor Series factory-set remote options are not preferred. For instance, where a newly remodeled location has an existing remote key switch different from a Furman remote key switch design; the mechanics of key switch are the reverse. Yet it would be advantageous to use the existing key switch, since many personnel already have keys. DIP 5 (+12V, ON OFF) and DIP 6 (GND ON) could possibly address such situations. Please feel free to contact Furman, if further assistance is necessary.

DIP 7 is used to set the remote switching preference. The CN-1800S can be set to a Maintained Mode (DIP 7 OFF or DOWN) or a Momentary Mode (DIP 7 ON or UP) dependent upon the chosen method of remote switching. A Maintained switch method stays open until switched, and then remains closed until switched again (such as toggle switches, e.g. Furman RS-1 key lock switch). The Momentary switch method is normally open and stays closed only as long as the button is depressed (such as pushbutton switches, similar to the Furman RS-2 security switch). Momentary Mode does offer an advantage over Maintained Mode when multiple remote switching locations are desired. Due to technical flexibility, Momentary switching easily adapts when implemented with more than one remote switch. However, it is often thought Maintained switching is more stable, truly shunting control voltages when actuated. DIP 5 and DIP 6 offer additional methods of applying Maintained switching. Regardless of which switching method is chosen, when changing DIP 4, DIP 5, DIP 6, or DIP 7, it is required to reset the AC power to the unit.

The CN-1800S has one Momentary Mode of operation (DIP 7 ON or UP), which is also compatible with Furman Legacy products. As suggested, when more than one remote switching location is required, momentary switches offer an advantage. In addition to this benefit, multiple Primary units set to Momentary Mode can be interfaced together using the Remote Pole contacts +12V, REM and GND, wired in parallel pole to pole. No one unit is considered the Primary Unit, yet any unit can act as one. The multiple units' delay cycle would initiate at the same time, in combination with each other; in other words, the units would all start at once and all initiate a cycle down at once, once any Momentary switch (button) is pushed (including Remote Momentary switches). As mentioned, multiple momentary remote contacts should be used if more than one remote power up location is desired. If units by chance, drop out of sync, simply press and hold down the Start Sequence button for several seconds to re-sync. The wiring of multiple Primary Units in parallel via the Remote Pole contacts is a Furman legacy operation.

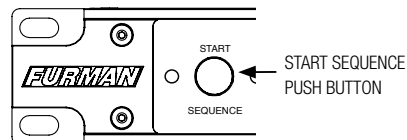

In addition, it should be noted, multiple Primary Units, in Momentary Mode, could be utilized in a complex SmartSequencing chain. The challenge is having each Momentary Primary controlling an isolated Secondary SmartSequencing chain. Once more, any Primary Start Sequence button could initiate a cycle up or cycle down; keeping in mind this sophisticated operation is only possible using the Remote Pole contacts of Momentary Mode Primary units; and then of course, using the SmartSequencing ports for the Secondary chain. As previously stated, the front panel Start Sequence pushbutton may be used in conjunction with one or more Remote Momentary switches connected to a Primary Remote Pole terminal strip. SmartSequencers set in Momentary Mode have optional possibilities.

The DIP 7 factory default position is Maintained Mode. Maintained switches are generally most convenient when there is only one remote location. It is important to note, SmartSequencing units also come factory-set for simple Maintained On operation (DIP 5 OFF or DOWN, DIP 6 OFF or DOWN, DIP 7 OFF or DOWN), as opposed to Maintained Off. Maintained Off is a state whereby a device is OFF until a maintained closure forces it ON. Maintained On is the opposite and no "shorted" contact is necessary, the device is ON until a remote contact is shorted. And besides the one momentary mode, the CN-1800S actually has many maintained contact switching solutions. As mentioned previously, two maintained functions are reserved to the FORCE OFF safety setting DIP 4, which has precedence over DIP 7. Below are three typical Remote Switch Maintained Modes of operation with regard to DIP 5, DIP 6, and DIP 7:

Maintained On (factory default)

REM to +12V = OFF

Setting DIP 5 OFF or DOWN, DIP 6 OFF or DOWN, DIP 7 OFF or DOWN, the dry contact connection across the REM terminal to the +12V terminal initiates an OFF sequence. Disconnecting initiates an ON sequence. If the cable run is long, it is recommended that the REM wire be tied to the SmartSequencer's GND terminal during ON operation rather than leaving it floating. This will require the use of a third conductor and a double-throw switch.

Maintained Off

REM to +12V = ON

Setting DIP 5 ON or UP, DIP 6 OFF or DOWN, DIP 7 OFF or DOWN, the dry contact connection across the REM terminal to the +12V terminal initiates an ON sequence. Disconnecting initiates an OFF sequence. If the cable run is long, it is recommended that the REM wire be tied to the SmartSequencer's GND terminal during OFF operation rather than leaving it floating.

Maintained Off (option 2)

REM to GND = ON

Setting DIP 5 OFF or DOWN, DIP 6 ON or UP, DIP 7 OFF or DOWN, the dry contact connection across the REM terminal to the GND terminal initiates an ON sequence. Disconnecting initiates an OFF.

DIP Switch position 8 determines the unit's role in the SmartSequencing™ hierarchy. If DIP Switch 8 is in the UP or ON position, the unit is set as the Primary Sequencer. If DIP Switch 8 is in the OFF or DOWN position, the CN-1800S will operate as a Secondary Sequencer. In an array of sequencers connected via SmartLink, there can be only one Primary Sequencer, and multiple (up to 99) Secondary Sequencers. A Primary Sequencer sends commands to a Secondary Unit. Please remember, a pair of conductors between the Primary OUT terminals and the Secondary IN terminals is all that is required. Which terminals are used at the IN port or the OUT port does NOT matter, the wiring scheme is indiscriminate. Furthermore, the Primary Sequencer has an active DE-9 RS-232 port that can be used to communicate with a local RS-232 control system or an Ethernet BlueBOLT adaptor. When a SmartSequencer is selected as a Secondary Unit (DIP 8 Down or OFF), the unit's RS-232 port is deactivated. Key Switch and Force Off function will also defeat the RS-232 port functions regardless of Primary or Secondary distinction. Please refer to SmartSequencing™ 101 page 6.

DIP Switch position 9 sets the EVS (Extreme Voltage Shutdown) recovery mode that the CN-1800S will employ. If Auto-Reset has been selected (DIP Switch position 9 ON or UP), the CN-1800S will attempt to re-set automatically within 5 seconds after the EVS condition has subsided.. If Manual Reset has been selected (DIP Switch position 9 is OFF or DOWN) the CN-1800S will not automatically reinstate power after the EVS condition has subsided. Instead, the user must use the key switch to clear the EVS error.

The EVS condition will be triggered if the incoming voltage exceeds 140V, or falls below 80V. Once the EVS has been triggered, all outlets will be disabled and the Extreme Voltage LED will illuminate. The EVS reset behavior will depend on the setting of DIP Switch 9. If the CN-1800S has been configured for manual reset, an operator must manually turn the affected unit's key switch to OFF and then back to REMOTE or ON. Please note, if there is an underlying wiring fault, EVS triggers may continue to be encountered. If this is the case, an operator should avoid resetting the unit without first checking the source of the problem and perhaps changing the AC source.

Power Indicators

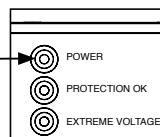
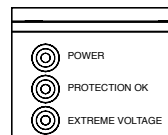

POWER: The POWER LED is normally illuminated Green whenever the unit is receiving AC power and the UNSWITCHED outlets are active.

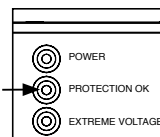

PROTECTION OK: The PROTECTION OK LED is normally illuminated Green when the CN-1800S is receiving AC power and the CN-1800S protective circuitry is operational. An unlit PROTECTION OK LED may indicate that damage has occurred (e.g. compromised due to moisture). Although the SMP and EVS features may still function, if this LED is not illuminated, please contact the Furman Service Department.

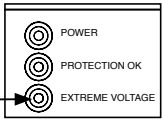

EXTREME VOLTAGE:

The EXTREME VOLTAGE LED indicator is normally OFF. The EVS function is tied to this LED and monitors common AC hazards, such as transients, wiring faults and accidental connection to 240V. The CN-1800S can sense voltages so high or so low that operation would be hazardous to connected equipment. The EVS disables AC power distribution before damage can occur. The EXTREME VOLTAGE LED will be illuminated Red if voltage events are below 80 volts or more than 140 volts. The EVS LED will remain illuminated, and the outlets will be disabled as long as an out of tolerance condition exists. Once addressed and the EVS event will be cleared and the CN-1800S will sense the correction and resume operation. If the EVS feature is triggered, the source voltage must return to an effective utility specification (90V-130V) and the EVS state must be cleared. Note: If the CN-1800S DIP Switch position 9 is configured for auto-reset, the unit should self-reset and clear the state automatically.

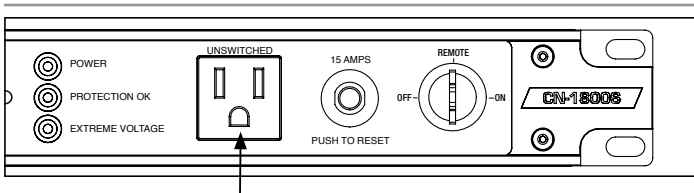

Unswitched Outlets

There are three unswitched outlets (one on front and two on back) that provide power at all times when the CN-1800S is plugged in and operating under normal power conditions. The outlets however, are affected by the EVS feature. The CN-1800S must have its power recycled to clear the state. If the EVS feature is triggered, the source voltage must return to within tolerance (90V-130V) and the EVS state must be cleared. Note: If the CN-1800S DIP Switch position 9 is configured for auto-reset (DIP 9 is ON or UP), the unit should self-reset and clear the state automatically. This outlet is not affected by the FORCE OFF feature.

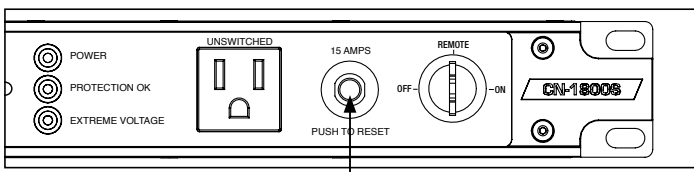

Circuit Breaker

The CN-1800S has a 15 Amp thermal circuit breaker button which will pop outward if the amount of current distributed to all loads exceeds 15 Amperes. To emphasize, if the combined current level, drawn by all devices plugged into all of the unit's nine outlets, exceeds 15 Amps at any time, the circuit breaker will "trip", cutting off power to all connected devices. If this occurs, the operator must reduce the load by unplugging one or more devices from the CN-1800S, and reset it. The operator can reset the circuit breaker by simply pressing in the circuit breakers button. However, because the safety feature is a thermal breaker, one may have to wait a few moments after the "trip" occurs for the breaker to cool down before the breaker will latch back on.

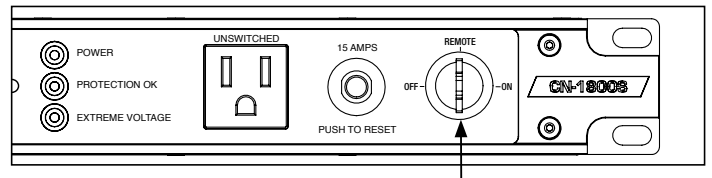

Key Switch

The 3 position key switch functions as a local ON or as a command bypass. The key switch controls power to the CN-1800S unit's DELAY outlets based upon the setting of DIP Switch position 8. For local control, an ON sequence is initiated by turning the key switch to the ON position, and an OFF sequence, by turning the key switch to OFF position. Note: when turning the key switch to REMOTE, after once turned to ON, the CN-1800S unit's SWITCHED outlets will remain on until the START SEQUENCE button is pushed. In the REMOTE position, the CN-1800S can accept on/off commands from either the back panel terminals or the RS-232 data link (COMM port). If the key switch is set back to OFF, this will initiate a shut down to the SWITCHED outlets. Note: the OFF position also defeats communication through the rear panel COMM port. The key switch must be in the ON or REMOTE position for the COMM port to relay commands. Furthermore, an ON position setting, functions in either MAINTAINED or MOMENTARY mode (i.e. regardless of DIP Switch position 7), effectively bypassing all other command functions, except FORCE OFF or EVS.

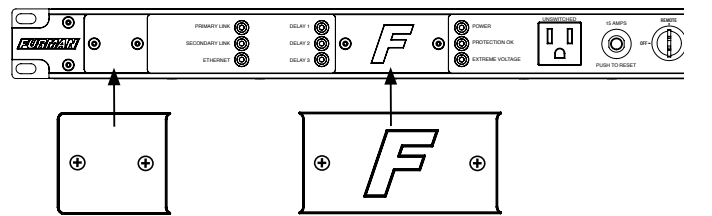

Security Covers

This CN Series Sequencer comes with Cover Shields to protect against inadvertent shutdowns and to help prevent against unauthorized system changes. Security Covers discourage unauthorized personnel from running or shutting down the CN-1800S Contractor Series SmartSequencer. Furthermore, the Security Covers ensure the DIP Switch settings will not be tampered with or adjusted improperly once the unit is installed. The Cover Shields fasten to fitting positions on the front panel. Please use the four metric M3 Screws for this purpose. Please remember this important Contractor Series feature should address many concerns in regards to security, but each location may need additional security based upon particular situations.

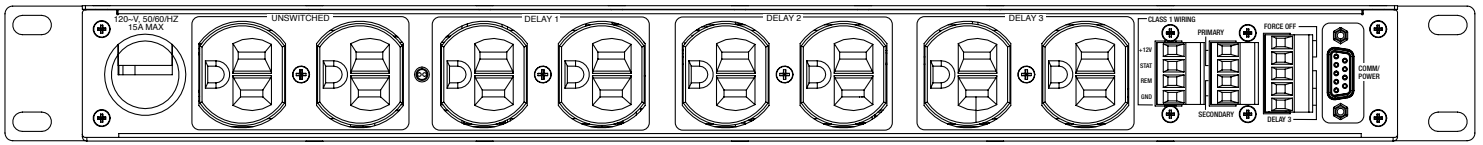

Rear Panel Overview

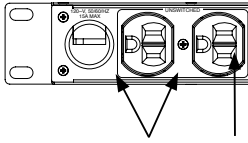

Unswitched Outlet Bank and Power Indicator

Unswitched Outlet Bank and Power Indicator This duplex bank provides power at all times when the CN-1800S is plugged in and operating under normal power conditions. A Green LED to the right of this bank indicates when AC power is present. The duplex is protected by the FORCE OFF and EVS features of the CN-1800S. If the EVS feature is triggered, the source voltage must return to within tolerable conditions (90V-130V) and the EVS error must be cleared. Note: If the CN-1800S DIP Switch Position 9 is ON or UP, the unit should self-reset and clear out the EVS error automatically. If DIP Switch Position 9 is OFF or DOWN, the EVS error will not be cleared automatically. The user must turn the key switch to the OFF position and then back to the REMOTE or ON position before the EVS error will clear. If the FORCE OFF feature is triggered, the user must turn the key switch to the OFF position and then back to the REMOTE or ON position before the FORCE OFF error will clear.

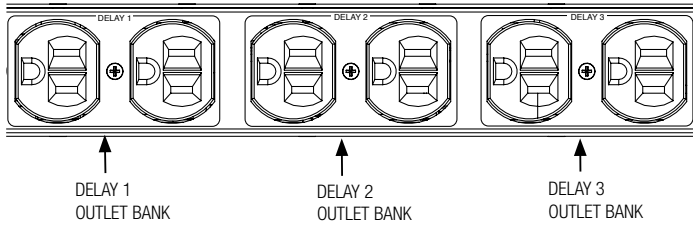

Delay Banks

The CN-1800S rear panel provides three pairs of SWITCHED outlets. These switched outlet pairs/duplexes are labeled DELAY 1, DELAY 2 and DELAY 3. When the unit's SEQUENCE ON function is initiated, DELAY 1 outlet bank receives power instantly, DELAY 2 outlet bank receives power 0-330 seconds later and DELAY 3 outlet bank receives power 0-330 seconds after DELAY 2 outlet bank is powered. When OFF is initiated, the sequence order is reversed, with DELAY 3 losing power instantly, DELAY 2 bank losing power 0-330 seconds later and DELAY 1 outlet bank losing power 0-330 seconds after DELAY 2 bank is shut down. The delay intervals may be altered at the Time Delay Adjustment control pot and DIP settings 1, 2, & 3. The control pot is adjustable with a screwdriver and both features are located under the security shield, at the center of the front panel. The combination of the Time Delay Adjustment and the DIP setting can up provide up to 7 minutes of delay time.

Terminal Barrier Strips

Barrier Strip (1) – 4 Pin

The Remote Barrier strip allows one or more remote location switches to be connected to the CN-1800S. The switch or switches used may be either a momentary or maintained-contact type. In the most basic MOMENTARY configuration, only a Normally Open SPST push button switch connected between REM and +12V is needed to initiate a remote ON or OFF sequence. To support this configuration, DIP switch positions 4, 6, and 7 should be in the ON or UP position. The REMOTE Barrier strip also provides for an externally mounted LED status indicator using the STAT and GND pins. The Status LED should be connected such that its Anode (the longer lead) is connected to the STAT pin and its Cathode is connected to the GND pin.

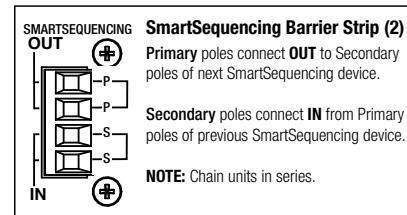
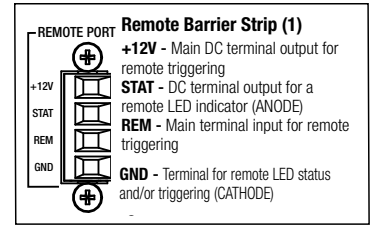

Barrier Strip (2) – 4 Pin

The SmartSequencing Barrier Strip is used to connect and daisy-chain other SmartSequencing Barrier units together. A pair of conductors between the **Primary OUT** terminals and the **Secondary IN** terminals is all that is required. The recommended wire gauge is 24AWG, but other wire gauges are possible if not available.

Barrier Strip (3) – 5 Pin

This Relay Barrier strip performs two functions. The FORCE OFF section provides terminals for initiating an immediate shutdown with a dry contact closure. Fire alarms and other safety measures can interface this section on the barrier's top two poles. If by chance this latest Furman Sequencer, the CN-1800S is used in conjunction with legacy Furman sequencing products, such as the ASD-120, the DELAY 3 pole section can be used to trigger the older product. The DELAY 3 section provides a dry contact closure timed in series with the DELAY 3 outlet bank. The DELAY 3 contact closure will work in either normally closed (NC) or a normally opened (NO) fashion. Please note, when the indicator DELAY 3 on the front panel is lit, this will indicate the DELAY 3 terminal poles have shorted the Delay 3 dry contact, Common (C) to Normally Open (NO). If all Delay LEDs are off, the Delay 3 dry contact will short Common (C) to Normally Closed (NC).

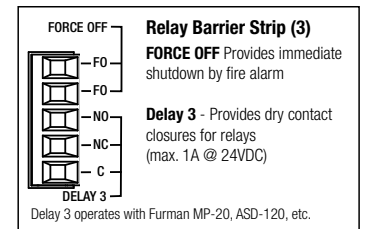

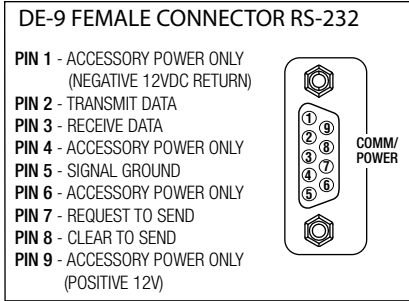
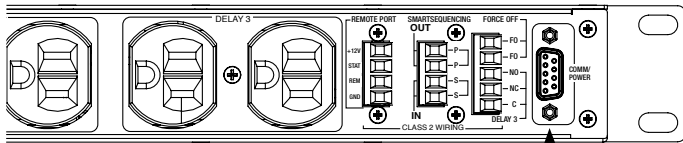

COMM Port

DE-9 Communications port can also provide power. Pin 2, Pin 3, and Pin 5 can be used for non-Furman RS-232 devices and protocols. Please note that +/- 12VDC power is provided on this interface. The user must verify pin assignment and electrical compatibility with other manufacturer's equipment before connecting to this port.

IMPORTANT, PLEASE READ

DE-9 Communications port can also provide power. Pin 2, Pin 3, and Pin 5 can be used for non-Furman RS-232 devices and protocols. Please verify pin assignment and protocol of another manufacturer's device before connecting to port.

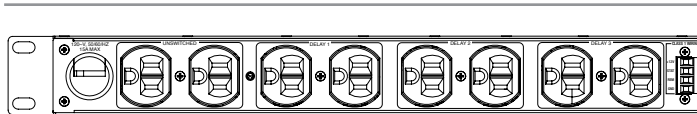

Outlets and Plugs:

The CN-1800S unit's four rear panel outlet pairs are standard 120V, 15A duplex types. These outlets are widely spaced, to accommodate one bulky plug-mounted "wall wart" power supply in each without covering up an adjacent outlet. The front panel outlet is limited to 15 Amp use and is filtered. The CN-1800S also uses a 14AWG 15 Amp line cord.

Setup and Troubleshooting

As discussed at the introduction, in order to prevent expensive repairs to speaker enclosures, a power sequencer or multiple power sequencers are employed to coordinate AC power to an A/V system. The amplifiers receive AC power last when a system is turned on and amps have the AC power cut before the signal processing is turned off. There are many applications besides those pro audio applications discussed here and SmartSequencing opens up many possibilities. In regards to pro audio, we cover the basics within our documentation, yet this does not mean that other applications cannot garner the benefits of SmartSequencing. Security and IT professionals can also benefit from remote power management and power sequencing. Please feel free to consult a Furman professional to answer any questions or to address the needs for any particular installation.

Single Unit Set Up

Basic installation of the CN-1800S is ready to go out of the box. The default DIP Switch settings should be appropriate for most applications. Plug amplifiers into DELAY 2 or divide them into two groups and plug one group through DELAY 2 and the other through DELAY 3. Low level equipment such as mixers and signal processors should use DELAY 1. Equipment incorporating special needs such as a DVR or offline UPS units should use the UNSWITCHED outlets, e.g. equipment that must respond to wireless remote actuation, such as projector. We suggest keeping the front panel UNSWITCHED outlet free for equipment that is used temporarily. The Key Switch can be used as the main method of On Off operation or the Key Switch may be set to Remote and the Start Sequence pushbutton can be used for On Off operation. If the Start Sequence pushbutton is preferred over the Key Switch, simply do not use the pushbutton's cover shield. Once all AC connections have been made, test the set-up and calibrate the timing range with a small screw driver if necessary. Then secure the Matrix's cover shield back into place.

Breaker Overload

The overall current capacity of the CN-1800S is 15 Amps. This refers to the combined steady-state current drawn by all devices plugged into all of its nine outlets. If this combined current level exceeds 15 Amps at any time, the circuit breaker will trip, cutting off power to the connected equipment. If this occurs, the operator must reduce the load by unplugging one or more units from the CN-1800S. Then push the button on the circuit breaker (on the front panel) in order to reset it. Although 15 Amps is an absolute limit, the CN-1800S will allow the operator to come as close as possible to using the full 15 Amps. Power sequencing greatly reduces the risk of tripping the breaker because the CN-1800S handles large but temporary inrush currents in stages, rather than simultaneously, allowing each stage to settle to its steady-state current draw before the next stage is powered. If for any reason, reasonable efforts are made to resolve breaker trips and trips continue, please do not hesitate to contact Furman technical support.

Re-syncing Multiple Sequencers

As discussed in previous sections, there can be unique situations where multiple sequencers fall out of sync. This could occur because an electrical circuit experiences an overload or high voltage. In the cases involving Furman's modernized SmartSequencing, an operator can press and hold the Start Sequence pushbutton on the Primary Unit for several seconds (or cycle the Primary to OFF on the Key Switch). When pressing and holding the pushbutton on dedicated SmartSequencing units, the Primary Unit commands the Secondary Units to "Go Home" and all units will sequence down in order. Once completely cycled off, the sequencers can be sequenced on again by pressing the START SEQUENCE button or turning the key switch to the ON position.

Re-syncing multiple sequencers in a Momentary Mode, whereby all units are Primary, and wired in parallel across +12V, REM, and GND, re-syncing can be accomplished by pressing and holding the Start Sequence pushbutton. Unlike the SmartSequencing chains, units will cycle down, yet may not cycle down in a hierarchical order. It would be advised that all sound sources be muted before a re-sync action is initiated. Once the re-sync is initiated, unit will cycle down and return to an off state. A sequence can now be "ramped up" in order.

RS-232 disconnect

If a contractor unit loses communication to a controller or computer it is advisable to set the unit's Key Switch to OFF in order to re-establish communication. Checking the physical connection would also be advisable if communication is still not established.

BlueBOLT Communication

If the Ethernet LED does not illuminate, even though all attempts have been made and the physical connection is known to be good, please also ensure BlueBOLT indicator on the adapter is illuminated. If the adapter LED is valid, please contact Furman Technical Support. Please note the adapter is host to the IP Address and not the CN-1800S itself.

15 YEAR LIMITED PRODUCT WARRANTY

Furman warrants to the original purchaser of this product for a period of fifteen (15) years from the date of purchase, that the unit shall be free of defects in design, material or workmanship, and Furman will repair or replace any defective unit.

Full Warranty and Policy information available at
www.furmancontractor.com

CAUTION! WARRANTY LIMITATION FOR INTERNET PURCHASERS

Furman products purchased through the Internet do not carry a valid Product Warranty unless purchased from an Authorized Furman Internet Dealer and the original factory serial numbers are intact (they must not have been removed, defaced or replaced in any way). Purchasing from an Authorized Furman Internet Dealer insures that the product was intended for consumer use, has passed all quality inspections and is safe. Buying through auction sites or unauthorized dealers may result in the purchase of salvaged, failed and/or products not intended for use in the US. In addition, Authorized Furman Internet dealers have demonstrated sufficient expertise to insure warranty compliant installations.

For a list of Authorized Furman Internet Dealers
go to www.furmansound.com

Specifications

Maximum AC Current Rating:

- 15 Amps, 120 VAC (Thermal breaker)

AC Cord:

- 3/14 AWG, 10 feet, black, fixed, NEMA 5-15P plug

AC Receptacles:

- Convenience Outlet (Front Panel) 1 Unswitched NEMA 5-15R
- Rear Panel Outlets: 2 Unswitched NEMA 5-15R (1 duplex),
- 6 Sequenced NEMA 5-15R (3 duplexes each controlled by separate relay)

Surge/Under-Overvoltage Protection:

- AC Surge Protection: SMP
- Spike Protection Mode: Line to neutral, zero ground leakage
- Spike Clamping Voltage: 188VAC peak @ 6,000 Volts/3,000 Amps
- Response Time: 1 nanosecond
- Maximum Surge Current: 6,500 Amps
- AC Undervoltage Protection: EVS, 77VAC+/-3VAC
- AC Overvoltage Protection: EVS, 145VAC+/-5VAC
- AC Overvoltage Reset Modes: Manual and Auto-reset (configurable)

AC Filtering:

- LiFT
- Noise Attenuation: Linear, 10dB @10KHz, 40dB@100KHz, 50dB@500KHz

Operating Temperature Range:

- 5C (40F) to 40C (105F) degrees

Humidity Range:

- <90% rH (Relative Humidity)

User Interface:

- Keyswitch: Front panel, 3-position keyswitch (On, Off, Remote)
- Keys: Included, 1 pair
- Pushbutton Switch: Front panel, hidden by security cover
- Thermal Circuit Breaker: Front panel, pushbutton
- Front panel diagnostic indicators: Primary link, Secondary link, Ethernet, Delay 1, Delay 2, Delay 3, Power, Protection OK, Extreme Voltage
- Front Panel DIP Switches: Front panel, hidden by security cover, 1 Minute Delay, 2 Minute Delay, 4 Minute Delay, Force Off NO/NC, 12V Mode On/Off, GND Mode On, Momentary/Maintained, Primary/Secondary, EVS Reset Auto/Manual
- Potentiometer: Front panel, time calibration hidden by security cover, fine tune delay adjust

Control/Status/Triggering (Rear Panel):

- Remote Terminal: +5-30VDC In, 12VDC (12mA) Out
- SmartSequencing: Phoenix type 4-Pin Connector, with Screw Terminals, Primary & Secondary Links (Current Loop - 1000' nominal)
- Remote Terminal: Phoenix type 4-Pin Connector with Screw Terminals; +12V, STAT, REM, GND (Class 2 Wiring)
- Force Off/Delay 3 Terminal: Phoenix type 5-Pin Connector with Screw Terminals, FORCE OFF, DELAY 3 (Class 2 Wiring)
- RS-232 Compatible: DE-9 Connector
- IP Addressability: Optional, via BB-RS232 Ethernet/RS-232 Adaptor (sold separately) for IP control via BlueBOLT®
- Voltmeter: Available with RS-232 and other options, +/- 1VAC accuracy
- Ammeter: Available with RS-232 and other options, +/-0.3 A accuracy

Power Consumption (No Load): • 10 Watts

Safety Agency: • NRTL-C

CSA/NRTL Compliant:

Specifications subject to change due to product upgrades and improvements.

FURMAN

Furman • 1800 S. McDowell Blvd. • Petaluma, CA. 94954
800-472-5555 • www.furmansound.com

© 2015 Core Brands. All rights reserved. Furman is a registered trademark of Core Brands, a company of Nortek, Inc.