

Quick Check **“Red”**

Tension Meter

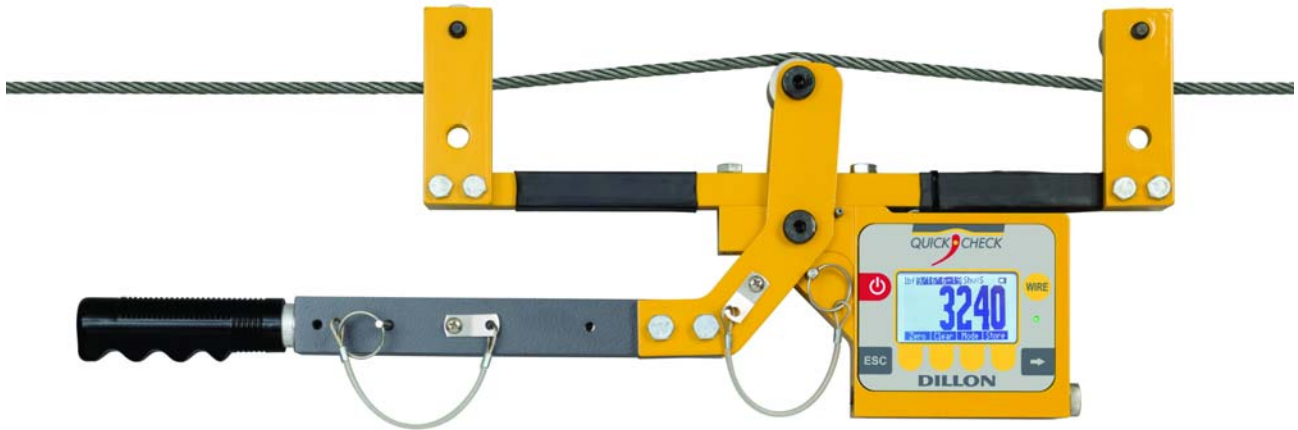

User Instructions

Dillon is part of Avery Weigh-Tronix. Avery Weigh-Tronix is a trademark of the Illinois Tool Works group of companies whose ultimate parent company is Illinois Tool Works Inc ("Illinois Tool Works"). Copyright © 2014 Illinois Tool Works. All rights reserved.

No part of this publication may be reproduced by making a facsimile copy, by the making of a copy in three dimensions of a two-dimensional work and the making of a copy in two dimensions of a three-dimensional work, stored in any medium by electronic means, or transmitted in any form or by any means, including electronic, mechanical, broadcasting, recording or otherwise without the prior written consent of the copyright owner, under license, or as permitted by law.

This publication was correct at the time of going to print, however Avery Weigh-Tronix reserves the right to alter without notice the specification, design, price or conditions of supply of any product or service at any time.

Table of Contents

Chapter 1 General Information and Warnings	5
About this Manual	5
Text Conventions	5
Special Messages	5
Safe Handling of Equipment with Batteries	6
Routine Maintenance	6
Cleaning the Machine	6
Training	6
Sharp Objects	6
FCC and EMC Declarations of Compliance	7
Declaration of Conformity (Quick Check Red)	8
Declaration of Conformity (EDX PSU)	9
Chapter 2 Introduction	10
Unpacking	10
Front Panel and Keys	11
Important Features	12
Using Quick Check (Red) with EDXtreme PSU	12
Quick Check Connector	12
External Power Supply	13
Chapter 3 Operation	14
Typical Operation	14
Measurement Practices	15
Softkey Functions	16
Top level Softkeys	16
Chapter 4 Configuration Mode	26
Accessing the Configuration Mode	26
Chapter 5 Changing Sheaves	30
Chapter 6 Achieving Best Accuracy	31
Accuracy	31
Calibration to Specific Wire Type	31
Loading Error	31
Non-repeatability	31
Non-linearity	32
Wire Characteristics	32
Chapter 7 Troubleshooting	33
Quick Check	33
EDX PSU	34
Chapter 8 Specifications	35
EDX PSU Power Supply Specifications	36

1 General Information and Warnings

1.1 About this Manual

This manual is divided into chapters by the chapter number and the large text at the top of a page. Subsections are labeled as shown by the 1 and 1.1 headings shown above. The names of the chapter and the next subsection level appear at the top of alternating pages of the manual to remind you of where you are in the manual. The manual name and page numbers appear at the bottom of the pages.

1.1.1 Text Conventions

Key names are shown in **bold** and reflect the case of the key being described. This applies to hard keys and onscreen or soft keys.

Displayed messages appear in ***bold italic*** type and reflect the case of the displayed message.

1.1.2 Special Messages

Examples of special messages you will see in this manual are defined below. The signal words have specific meanings to alert you to additional information or the relative level of hazard.



CAUTION!

This is a Caution symbol.

Cautions give information about procedures that, if not observed, could result in damage to equipment or corruption to and loss of data.



NOTE: *This is a Note symbol. Notes give additional and important information, hints and tips that help you to use your product.*

1.1.3 Safe Handling of Equipment with Batteries



CAUTION: *Danger of explosion if battery is incorrectly replaced. Replace only with the same or equivalent type recommended by the manufacturer. Dispose of used batteries according to the manufacturer's instructions.*

ATTENTION: *Il y a danger d'explosion s'il y a remplacement incorrect de la batterie, remplacer uniquement avec une batterie du même type ou d'un type équivalent recommandé par le constructeur. Mettre au rebut les batteries usagées conformément aux instructions du fabricant.*

1.2 Routine Maintenance



IMPORTANT: *This equipment must be routinely checked for proper operation and calibration. Application and usage will determine the frequency of calibration required for safe operation.*

1.3 Cleaning the Machine

Table 1.1 Cleaning DOs and DON'Ts



DO	DO NOT
Wipe down the outside of standard products with a clean cloth, moistened with water and a small amount of mild detergent	Attempt to clean the inside of the machine
	Use harsh abrasives, solvents, scouring cleaners or alkaline cleaning solutions
Spray the cloth when using a proprietary cleaning fluid	Spray any liquid directly on to the display windows

1.4 Training

Do not attempt to operate or complete any procedure on a machine unless you have received the appropriate training or read the instruction books.

To avoid the risk of RSI (Repetitive Strain Injury), place the machine on a surface which is ergonomically satisfactory to the user. Take frequent breaks during prolonged usage.

1.5 Sharp Objects

Do not use sharp objects such as screwdrivers or long fingernails to operate the keys.

1.6 FCC and EMC Declarations of Compliance

United States

This equipment has been tested and found to comply with the limits for a Class A digital device, pursuant to Part 15 of the FCC Rules. These limits are designed to provide reasonable protection against harmful interference when the equipment is operated in a commercial environment. This equipment generates, uses, and can radiate radio frequency energy and, if not installed and used in accordance with the instruction manual, may cause harmful interference to radio communications. Operation of this equipment in a residential area is likely to cause harmful interference in which case the user will be required to correct the interference at his own expense.

Canada

This digital apparatus does not exceed the Class A limits for radio noise emissions from digital apparatus set out in the Radio Interference Regulations of the Canadian Department of Communications.

Le présent appareil numérique n'émet pas de bruits radioélectriques dépassant les limites applicables aux appareils numériques de la Classe A prescrites dans le Règlement sur le brouillage radioélectrique édicté par le ministère des Communications du Canada.

European Countries

WARNING: This is a Class A product. In a domestic environment, this product may cause radio interference in which the user may be required to take adequate measures.

1.7 Declaration of Conformity (Quick Check Red)

DILLON

Dillon is part of Avery Weigh-Tronix
 Foundry Lane, Smethwick, West Midlands, B66 2LP, England

CE	Declaration of Conformity	Konformitätserklärung
	Verklaring van Overeenstemming	Dichiarazione di conformità
	Déclaration de Conformité	Declaración de Conformidad

Manufacturer Type Dillon Quick Check "Red"	Fabrikant Type Dillon Quick Check "Red"	Fabricant Type Dillon Quick Check "Red"
corresponds to the requirements of the following EC directives:		
EMC Directive 2004/108/EC Low Voltage Directive 2006/95/EC	EMC Richtlijn 2004/108/EG Laagspanningsrichtlijn 2006/95/EG	Directive CEM 2004/108/CE Directive Basse Tension 2006/95/CE
The applicable harmonised standards are:		
EN61000-6-1:2007 EN 60950-1 : 2006 +A2:2013	EN61000-6-3:2007+A1:2011	EN61000-6-1:2007 EN 60950-1 : 2006 +A2:2013
ITW Ltd trading as Avery Weigh-Tronix Foundry Lane, Smethwick, West Midlands, B66 2LP, England Reg. Office: Admiral House, St Leonards Road, Berkshire SL4 3BL, England Registered in England No. 00559693		

Hersteller Typ Dillon Quick Check "Red"	Produttore Modello Dillon Quick Check "Red"	Fabricante Tipo Dillon Quick Check "Red"
entspricht den Anforderungen folgender EG-Richtlinien:		
EMV-Richtlinie 2004/108/EG Niederspannungs Richtlinie 2006/95/EG	Normativa EMC 2004/108/CE Normativa per la bassa tensione 2006/95/CE	Directiva CME 2004/108/CE Directiva de baja tensión 2006/95/CE
Die angewendeten harmonisierten Normen sind:		
EN61000-6-1:2007 EN 60950-1 : 2006 +A2:2013	EN61000-6-3:2007+A1:2011	EN61000-6-1:2007 EN 60950-1 : 2006 +A2:2013
ITW Ltd trading as Avery Weigh-Tronix Foundry Lane, Smethwick, West Midlands, B66 2LP, England Reg. Office: Admiral House, St Leonards Road, Berkshire SL4 3BL, England Registered in England No. 00559693		

Signature/Name Handtekening/Naam Signature/Nom Unterschrift/Name Firma/Nombre Firma/Nombre	K. Detert Global Head of R & D	Authorised signatory for Avery Weigh-Tronix Namens van Avery Weigh-Tronix Signataire autorisé d'Avery Weigh-Tronix Unterschriftsberechtigter für Avery Weigh-Tronix Firmatario autorizzato per Avery Weigh-Tronix Firmante autorizado para Avery Weigh-Tronix
		Date Datum Date Datum Data Fecha
		31 July 2014

76501-394 Issue 1

1.8 Declaration of Conformity (EDX PSU)

DILLON

Dillon is part of Avery Weigh-Tronix
Foundry Lane, Smethwick, West Midlands, B66 2LP, England



Declaration of Conformity
Verklaring van Overeenstemming
Déclaration de Conformité

Konformitätserklärung
Dichiarazione di conformità
Declaración de Conformidad

Manufacturer Avery Weigh-Tronix Type Dillon EDx PSU		Fabrikant Avery Weigh-Tronix Type Dillon EDx PSU		Fabricant Avery Weigh-Tronix Type Dillon EDx PSU	
corresponds to the requirements of the following EC directives:		is in overeenstemming met de voorschriften van de volgende EG richtlijnen:		correspond aux exigences des directives CE suivantes :	
EMC Directive 2004/108/EC Low Voltage Directive 2006/95/EC		EMC Richtlijn 2004/108/EG Laagspanningsrichtlijn 2006/95/EG		Directive CEM 2004/108/CE Directive Basse Tension 2006/95/CE	
The applicable harmonised standards are:		Toegepaste geharmoniseerde normen:		Les normes harmonisées applicables sont :	
EN61000-6-1:2007 EN 60950-1 : 2006 +A1:2009	EN61000-6-4:2007	EN61000-6-1:2007 EN 60950-1 : 2006 +A1:2009	EN61000-6-4:2007	EN61000-6-1:2007 EN 60950-1 : 2006 +A1:2009	EN61000-6-4:2007
ITW Ltd trading as Avery Weigh-Tronix Foundry Lane, Smethwick, West Midlands, B66 2LP, England Reg. Office: Admiral House, St Leonards Road, Berkshire SL4 3BL, England Registered in England No. 00559693		ITW Ltd trading as Avery Weigh-Tronix Foundry Lane, Smethwick, West Midlands B66 2LP, England. Reg. Kantoor: Admiral House, St Leonards Road, Berkshire SL4 3BL, England Geregistreerd in Engeland nr: 00559693		ITW Ltd trading as Avery Weigh-Tronix Foundry Lane, Smethwick, West Midlands, B66 2LP, Angletterre Siège social : Admiral House, St Leonards Road, Berkshire SL4 3BL, Angletterre Enregistré en Angletterre sous le numéro : 00559693	

Hersteller Avery Weigh-Tronix Typ Dillon EDx PSU		Produttore Avery Weigh-Tronix Modello Dillon EDx PSU		Fabricante Avery Weigh-Tronix Tipo Dillon EDx PSU	
entspricht den Anforderungen folgender EG-Richtlinien:		è conforme alle caratteristiche previste dalle seguenti direttive CE:		conforme a las exigencias de las siguientes directivas CE:	
EMV-Richtlinie 2004/108/EG Niederspannungs Richtlinie 2006/95/EG		Normativa EMC 2004/108/CE Normativa per la bassa tensione 2006/95/CE		Directiva CME 2004/108/CE Directiva de baja tensión 2006/95/CE	
Die angewendeten harmonisierten Normen sind:		Le norme standard armonizzate e nazionali applicate sono:		Las normas armonizadas en vigor son:	
EN61000-6-1:2007 EN 60950-1 : 2006 +A1:2009	EN61000-6-4:2007	EN61000-6-1:2007 EN 60950-1 : 2006 +A1:2009	EN61000-6-4:2007	EN61000-6-1:2007 EN 60950-1 : 2006 +A1:2009	EN61000-6-4:2007
ITW Ltd trading as Avery Weigh-Tronix Foundry Lane, Smethwick, West Midlands, B66 2LP, England Reg. Office: Admiral House, St Leonards Road, Berkshire SL4 3BL, England Registered in England No. 00559693		ITW Ltd trading as Avery Weigh-Tronix Foundry Lane, Smethwick, West Midlands, B66 2LP, England Sede legale: Admiral House, St Leonards Road, Berkshire SL4 3BL, England N. iscrizione al registro delle imprese inglese: 00559693		ITW Ltd trading as Avery Weigh-Tronix Foundry Lane, Smethwick, West Midlands, B66 2LP, Inglaterra. Reg. Office: Admiral House, St Leonards Road, Berkshire SL4 3BL, Inglaterra. Registrado en Inglaterra bajo el n.º: 00559693	

Signature/Name Handtekening/Naam Signature/Nom Unterschrift/Name Firma/Nombre Firma/Nombre	 K. Detert Global Head of R & D	Authorised signatory for Avery Weigh-Tronix Namens van Avery Weigh-Tronix Signataire autorisé d'Avery Weigh-Tronix Unterschriftsberechtigter für Avery Weigh-Tronix Firmatario autorizzato per Avery Weigh-Tronix Firmante autorizado para Avery Weigh-Tronix	Date Datum Date Datum Data Fecha
			1 April 2014

76501-389 Issue 1

2 Introduction

This manual covers the setup and operation of the Quick-Check Clamp Line Tensiometer from Dillon. The Quick-Check is a simple, accurate strand dynamometer. It can be clamped onto a cable, accurately determine the wire tension and be removed in seconds.

The Quick-Check can handle multiple wire diameters, it can display live tension, dual live/peak tension, average tension captured from several tests, and a check-tensioning graphical display.

With its battery-powered electronic interface, setup and operation is made simple with on-screen prompts.

This manual covers the following:

- Unpacking
- Setup
- Operation
- Maintenance
- Troubleshooting

2.1 Unpacking

When you receive your Quick-Check, unpack it and inspect the container and the instrument for any damage. Report any problems to the shipping company immediately and save the packing materials.

Insert 2 AA batteries into the battery compartment, shown in Figure 2.1. Your Quick-Check probably comes from the factory with the proper sheave size installed and calibrated for your application. If not, follow the setup directions later in section 3.0 Configuration Mode and section 4.0 Changing Sheaves.

The Quick-Check is shown in Figure 2.1 with the different parts labeled.

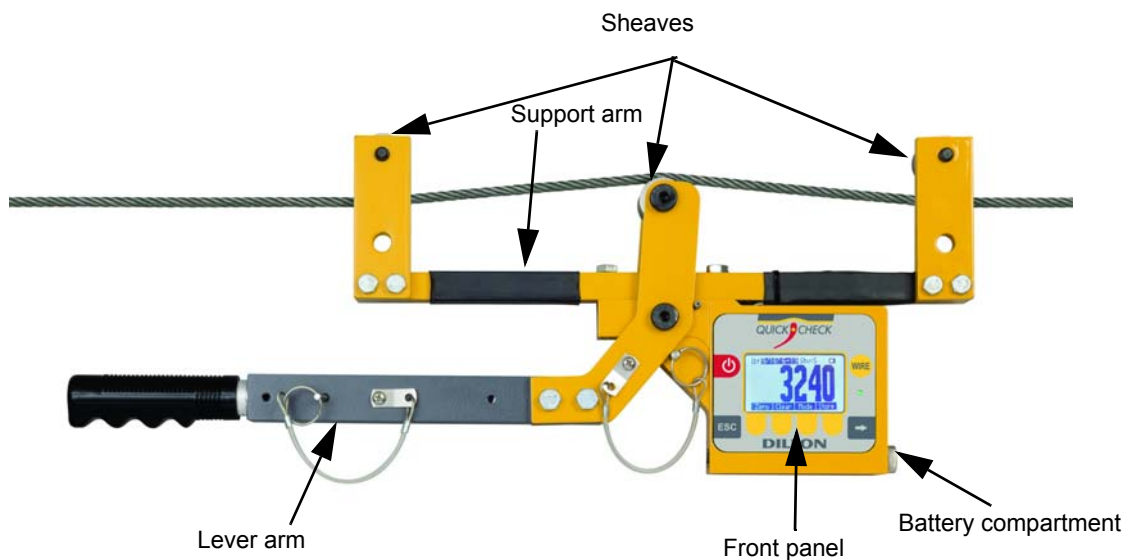

Figure 2.1 Quick-Check Parts

2.2 Front Panel and Keys

The front panel of the Quick-Check is shown in Figure 2.2. The light located under the WIRE button illuminates green when changes in the menu are stored, purple when in diagnostics or uploading firmware and red when powering the unit down.

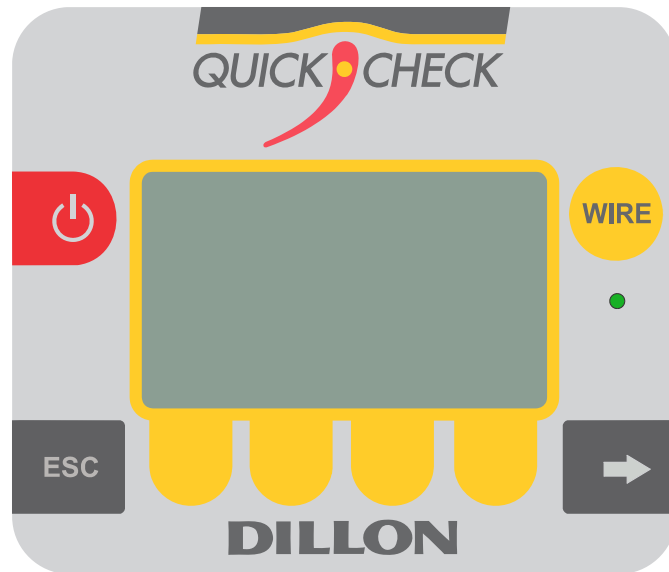

Figure 2.2 Quick-Check Front Panel

Following are descriptions of the keys and their functions:



ON/OFF key. Press this key to power up and turn off the Quick-Check.



ESC key. Press this key to escape an area of the menu or to clear the field when in data entry mode.



WIRE key. Press this key to change the wire diameter you are testing with the Quick-Check. Choose from the listed selection and when the desired size is highlighted, press the ENTER softkey. Up to 20 sizes available.



Soft key. Softkey function changes as needed for different tasks. The soft key labels appear above the keys themselves. You will use these for operation and configuration.



Arrow key. Press this key to reveal more softkeys in a group of softkeys.

2.3 Important Features

Quick to use	Attaches and removes from tensioned line in seconds.
	Quick-tensioning readout for ultra fast line tensioning.
Direct tension readings	No more complicated lookup charts! Save time and improve accuracy.
Portable & rugged	Designed for outdoor use.
Accurate	Employs Weigh Bar® technology used for precise weighing.
Multiple wire size storage	Stores up to 20 different calibrations.

2.4 Using Quick Check (Red) with EDXtreme PSU

The Quick Check can be connected to the EDX PSU via the Comm Port. This 120VAC/240VAC external power supply will supply power to the Quick Check instead of AA batteries.

2.4.1 Quick Check Connector

The connector on the Quick Check is recessed for protection. Lift the protective cap to access the connector. It is used to connect the instrument to a printer, PC or external power supply. See your Dillon distributor for details.



Figure 2.3 Quick Check Connector

2.4.2 External Power Supply

Plug the 4-pin end of the power supply cable into the Quick Check 4-pin connector located on the side of the unit. Plug the power supply adapter into an AC power outlet. Refer to [Figure 2.4](#) for a photo of the external power supply.



Figure 2.4 External Power Supply Connection



Figure 2.5 External Power Supply (EDX PSU) (120 - 240 VAC 50 - 60 Hz)

3 Operation

Typical operation of the Quick-Check is covered below, followed by explanations of the various display modes, how to change wire size, how to change the unit of measure, etc.

3.1 Typical Operation

To perform a typical tension measurement, see the note below and follow these steps:



Take readings at three different places along the cable, moving the tension meter at least four inches for each reading. Take the average of the readings. The built-in average function is ideal for this task.

The handle quick release pin should be used when the Quick-Check is attached to a cable that will be de-tensioned and re-tensioned. The pin prevents the handle from opening once the tension falls to a small level. The pin should also be used if the Quick-Check will be installed for a prolonged period.

1. Turn the unit on by pressing the **ON/OFF** key...

The display shows **DILLON** briefly, then, in this example, the screen shows the following:

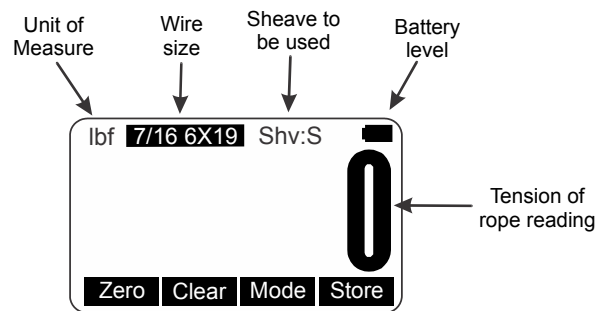

Figure 3.1 Sample Display



Press the **WIRE** key to list the stored calibrations.

2. This example shows the wire is a 7/16", 6X19 stranded cable using the "S" Sheave and the unit of measure is lbf. Place the Quick-Check so the two outside sheaves hang on the wire. Insure that the wire rope is riding in the center groove for all three sheaves. See Figure 3.2. Press the **Zero** softkey to zero the display.

0 should be displayed.

3. Raise the lever arm until it locks in the upright position to apply tension to the wire. Read the line tension on the display.

4. Release the lever arm and you are ready to perform another measurement.



Figure 3.2 Quick-Check Attached to Cable

3.2 Measurement Practices

For best measurement, install the Quick-Check at least 2 feet (0.6 m) from terminations, clamps or other hardware. Do not install over the top of wire wrappings.

Take readings at three different places along the cable, moving the tension meter at least four inches for each reading. Take the average of the readings. The built-in average function is ideal for this task.



WARNING: Do not apply tension greater than rated capacity of the instrument or overload damage to the sensor may result. Do not use the Quick-Check with cable larger than indicated on the sheaves. Overload and damage to the instrument may result. Do not mix sheave sizes. This will result in inaccurate measurement and possible overload.

Do not use the Quick-Check to measure tension for wires if any of the following are true:

1. No wire calibrations are stored of the same diameter as the wire you are looking to measure, and/or
2. You do not have sheaves of the same diameter.

If both of these conditions exist, contact your Dillon distributor.

Contact your Dillon distributor to improve accuracy for a specific wire type by calibrating to it.

Insure that the wire rope is riding in the center of the groove for all three sheaves.

Insure sheaves installed agree with sheaves noted in the Wire calibration. **Exception:** Sheaves match the wire diameter of the cable to be measured and alternate calibration is selected as per section 5.2.

The Quick-Check has an internal temperature sensor inside the electronics cavity. Dramatic temperature changes (such as moving from a warm vehicle to cooler outdoors) requires time for the sensor to reach the same temperature. Direct sunlight will heat the electronics cavity and cause higher readings than actual ambient temperature. **NOTE: The temperature is only for the Quick Check electronics and does not compensate for the temperature of the wire rope.**

For best tension accuracy, use the exact temperature of the wire along with the cable manufacturer's temperature compensation chart. This may be widely different from the ambient temperature if the cable has been sitting in direct sunlight.

3.3 Softkey Functions

Now that you've seen a simple operation, we'll explain the softkey functions. Figure 3.3 shows the softkeys available during normal operation.

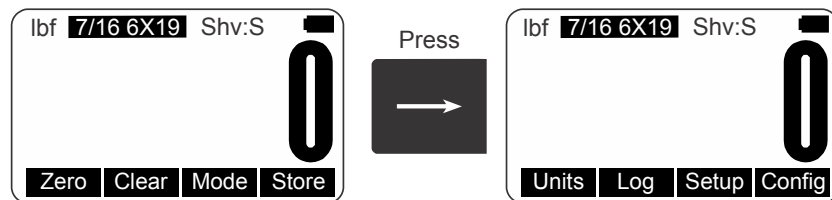

Figure 3.3 Normal Mode Softkeys

3.3.1 Top level Softkeys

At any time, press the **ESC** key to return to the normal operating mode. If changes have been made to the configuration, you will be prompted to save them (Yes) or abort the changes (No) before exiting the configuration mode.

Zero

Press this softkey to zero the force display. You would usually press this at the beginning of a series of tension tests but would not need to do it for every test unless there is some zero drift.

Clear

Press this softkey and you are prompted to clear the Peak reading or the Average. Make your choice by pressing the appropriate softkey and that value is cleared from memory.

Mode

Press the **Mode** key to scroll through the four display modes. These are explained below:

Live Tension Mode: The display shows the live tension.

Dual Peak Mode: The display shows the live tension on the top display and the peak force achieved on the bottom display. To clear the peak, remove any force on the Quick-Check, press the **Clear** softkey and follow the prompts.

Average Capture Mode: This mode shows the live tension in the top display and the average of all captured readings on the bottom display. To capture a reading and add it to the average, press the **Store** softkey when a force is applied to the Quick-Check. Follow the prompts to add (or not) the reading to the average. NOTE: Must set Log>Setup to Disabled for the Average Mode to work.

Check-tensioning Mode: Check-tensioning mode permits quick & easy graphical view of the applied tension versus the desired tension. This mode works well when you are repeatedly tensioning to the same tension range. This mode displays a bar graph representation of the tension being applied. See Figure 3.4. The black bar represents the range of the wire, from zero to ultimate wire rating. The wide white band is the tolerance window based on upper and lower thresholds you can enter. The live force is represented by the arrow and the white line on the black bar. When the force gets within $\pm 5\%$ of the acceptance window, a close-up of the acceptance window is displayed. See bottom example in Figure 3.4.



NOTE: Upper and lower thresholds are set in the Configuration WIRE menu. See page 27.

The Quick-Check has automatic tension targeting. Points may be entered from a linear Tension supplied table for a wire cable.

Display when tension is below the dotted, target box.

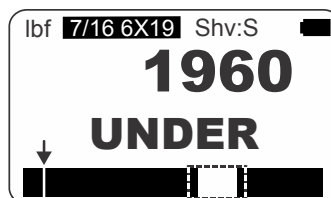

Display when tension falls within the dotted, target box.

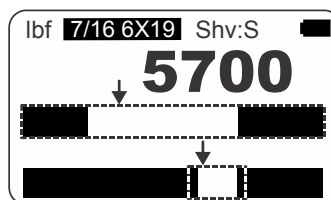



Figure 3.4 Check Tension Display

To exit the check-tension mode, press any softkey to display the softkey labels, then press the **Mode** softkey to scroll to the next mode. The next mode is the first mode that was described, live tension mode.

Store

Press the **Store** softkey to store and add a displayed tension to the average of other entered readings. Follow the onscreen prompts.

When Multi Leg/Wire is enabled in Log>Setup menu, each leg is identified by a letter rather than a number (A - I). Each tension wire (guy wire) is identified by a number. When the **Store** softkey is pressed, leg with be displayed. If more than one leg, use the **Sel** keys to select the desired Leg. Press **Enter** to go to the wire selections. Use the **Num** keys to select the wire number. Press **Enter** to store the tension reading. Refer to page 21 for more details.

Press the  key to move to the next set of softkeys.

Units

Press this key to set the Quick-Check for displaying:

- Force in lbf, kgf or N

Log

Log mode is used to log/record force and peak data. Press this softkey to view the number of records logged. This can be done on each lift, during a timed duration, during an overload or on Print key operation.

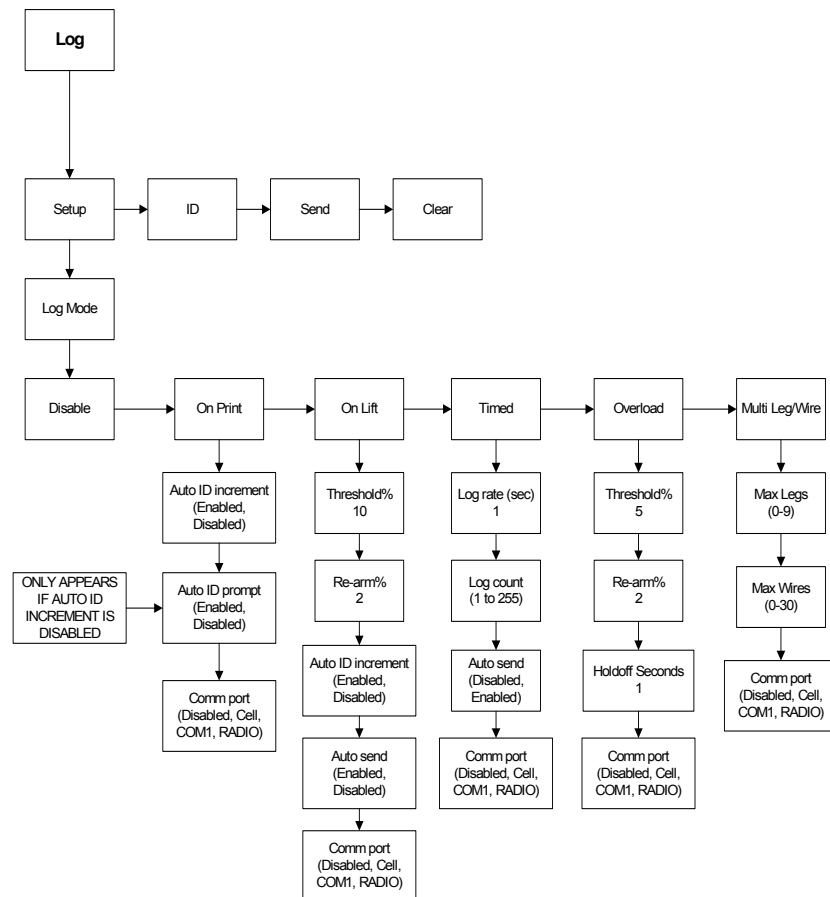

Figure 3.5 Log Menu



Note: All Log Modes will record Date and Time along with it's force and peak reading.

Setup:

Setup allows the user to configure how the Quick Check stores data internally. This stored data can be downloaded via the 4 pin Lemo to a PC via a keyboard wedge or other device.

- **Log Mode:**

Disable: Turns the log feature off.

On Print: Used when the operator wants to do a lift and store of the force and peak.

Auto ID Increment: Enable/Disable

This will increment the ID by 1 every time the "PRINT" key is pressed and store it with each force and peak.

Auto ID Prompt: Enable/Disable (will only appear if Auto ID Increment is Disabled)

If "Enabled", the operator will be prompted to key in an ID before storing that ID with the force and peak.

Comm Port:

This allows you to choose where to export the "ON PRINT" logged data.

- a. Cell = Setup Cell for data export (4 pin Lemo)
- b. Com1 = Not used
- c. RADIO = Future development
- d. Disabled = to turn off

On Lift: Used when the operator wants the load to be automatically stored, once the load becomes stable. Note: additional filtering may be required, as the load must be steady before the load will be recorded.
Maximum Records = 255

Threshold %: (based on capacity)

This is the load above where the unit will record the stable load.

Re-arm: (based on capacity)

This is the load the force must drop below before the "ON LIFT" will reset (re-arm) and store another load.

Auto ID Increment: Enable/Disable

This will increment the ID by 1 every time the "PRINT" key is pressed and store it with each force and peak.

Auto Send: Enable/Disable

Can export the readings live if enabled.

Comm Port:

This allows you to choose where to export the "ON PRINT" logged data.

- a. Cell = Setup Cell for data export (4 pin Lemo)
- b. Com1 = Not used
- c. RADIO = Future development
- d. Disabled = to turn off

Timed: This is used when the operator wants to record a live load/pull and store it internally. Can store up to 255 force readings.

Log Rate:

The speed at which the logging of force will be recorded. Based on seconds (Example 5 sec = Unit will record the force once every 5 seconds)

Log Count:

This is how many logs the operator wants to record. Range is 0 to 255 recorded readings.

Auto Send: Enable/Disable

Can export the readings live if enabled.

Comm Port:

This allows you to choose where to export the "ON PRINT" logged data.

- a. Cell = Setup Cell for data export (4 pin Lemo)
- b. Com1 = Not used
- c. RADIO = Future development
- d. Disabled = to turn off

Overload: This is used when an operator or supervisor wants to know if their equipment is being overloaded. This will be a percentage based on capacity and will be below 100% of the Quick Check. (This not the same as the 120% overload that the Quick Check records based on capacity.)
Maximum Records = 255

Threshold %: (based on capacity)

This the percentage above where the unit will record the peak load.

Re-arm %: (based on capacity)

This is the load percentage the force must drop below before the "OVERLOAD" will reset (re-arm) and store another load.

Holdoff Seconds:

Once the unit has recorded this overload, how much time will pass before this unit will re-arm and allow to record the overload again.

Comm Port:

This allows you to choose where to export the "ON PRINT" logged data.

- a. Cell = Setup Cell for data export (4 pin Lemo)
- b. Com1 = Not used
- c. RADIO = Future development
- d. Disabled = to turn off

Multi Leg / Wire: This is used to measure tension on tower guyed wires. The readings can be stored (refer to page 18).

Max Legs:

Enter the number of legs the tower has.

Max Wires:

Enter the number of guy wires each leg has.

Comm Port:

This allows you to choose where to export the "ON PRINT" logged data.

- a. Cell = Setup Cell for data export (4 pin Lemo)
- b. COM1 = Not used
- c. RADIO = Future development
- d. Disabled = to turn off

The data will be exported to a computer via RS-232. Dillon recommends using "WedgeLink" software as a keyboard wedge. The data needs to be comma delimited and can be exported to an Excel spreadsheet. Refer to Figure 3.6 for an example.

	A	B	C	D	E	F
1						
2						
3	RS-232 Output String, in the Multi/Leg mode					
4	When using a keyboard wedge. Separated with a comma					
5						
6	Example shown: A 3 Leg tower with 4 wires on each leg					
7						
8	"Force"	"Leg"	"Wire"	"Wire Description"	"Sheave"	
9	1460	"A"	1	3/8" 1X7 Str	S	
10	1960	"A"	2	7/16" 1X7 Str	S	
11	2580	"A"	3	1/2" 1X7 Str	T	
12	4120	"A"	4	5/8" 1X19 Str	T	
13	1440	"B"	1	3/8" 1X7 Str	S	
14	1980	"B"	2	7/16" 1X7 Str	S	
15	2600	"B"	3	1/2" 1X7 Str	T	
16	4140	"B"	4	5/8" 1X19 Str	T	
17	1460	"C"	1	3/8" 1X7 Str	S	
18	1960	"C"	2	7/16" 1X7 Str	S	
19	2580	"C"	3	1/2" 1X7 Str	T	
20	4120	"C"	4	5/8" 1X19 Str	T	
21						

Figure 3.6 Example of Tower Data

ID:

An operator can key in either a User ID number or a Lift ID assigned to a particular product. This is a numeric number only and can be any number from 1 to 65,000. (if you want to turn the ID off, key in 0).

Note: ID not used in Multi Leg/Wire mode.

Send:

This will export/send the Log information out the configured port.

Clear:

This will clear any data in the Log mode. Clearing "On Lift", "Timed", "Overload" and Multi Leg/Wire stored data.



Auto-off can preserve battery life.

Setup

Press the **Setup** softkey and you will see these choices; **Power**, **PtFmt**, **Misc**, **About**, **Test** and **Clock**. These are described below:

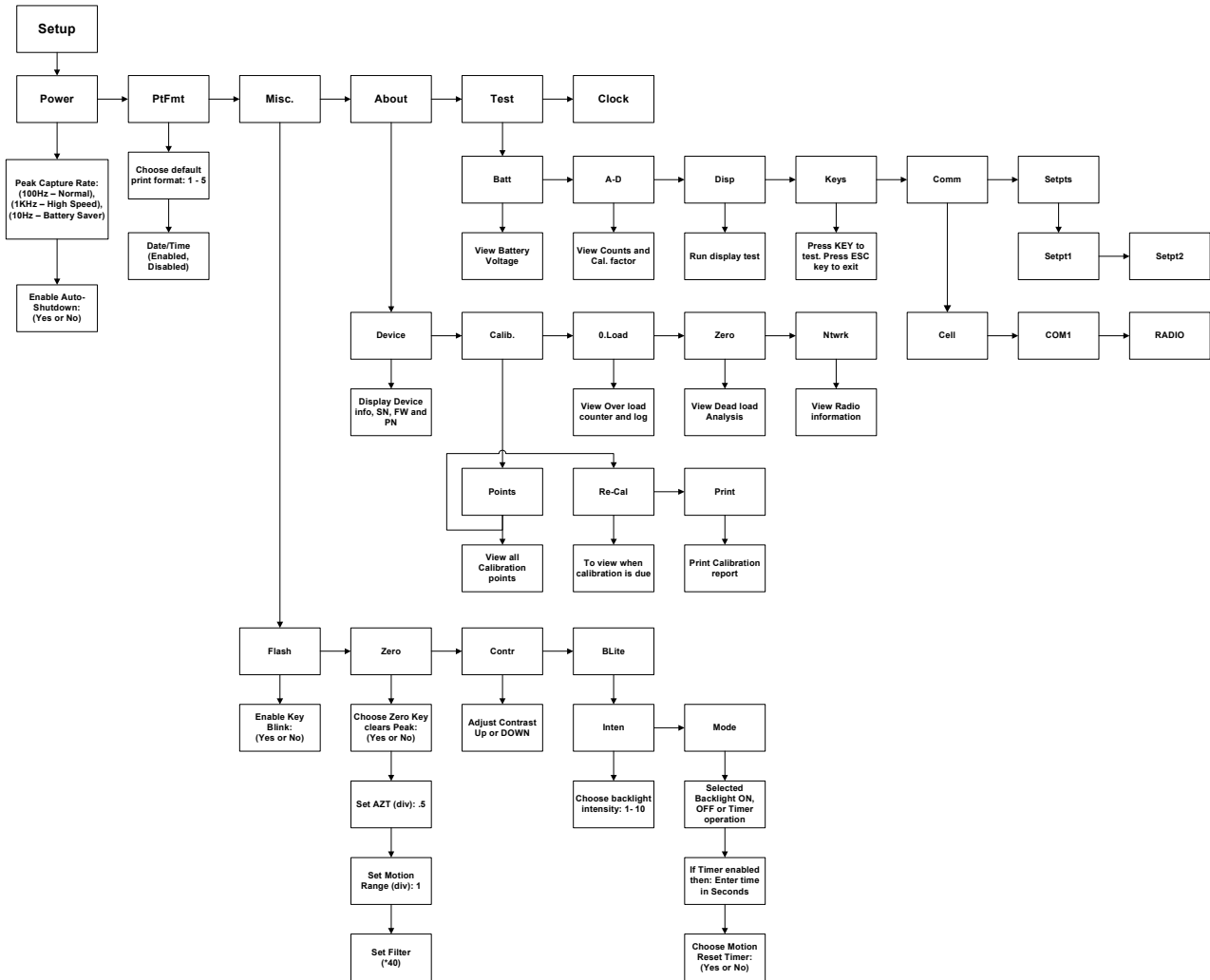

Figure 3.7 Setup Menu

Power:

Use this to set power management features

- **Peak Capture Rate** - Select a Peak Capture Rate by using the **Sel** keys to scroll through the choices. Choices are 100Hz - Normal, 1kHz - High Speed, and 10Hz - Battery Saver (default). Press **Enter** to accept the displayed setting.



Be aware that 1kHz - High Speed mode will consume more battery power.

- **Enable Auto-Shutdown** - Auto-Shutdown powers off the instrument automatically. If Yes is chosen, the following options will be displayed:

Shutdown Timer (Min): Program to shut down after a period of inactivity.

Shutdown Type: Select a method of shutdown.

Fixed: Set the amount of time for the unit to shut off

No Load: No load of the tension meter

No Change: No change in weight

PtFmt:

- **Default Print Format**
- **Print time and date**

Misc:

Press this softkey to set the following:

- **Flash** - Enables or disables the momentary blinking of the display to acknowledge a key press.
- **Zero** - Enables the use of the **Zero** softkey to clear a peak tension value.
- **Contr** - Press this key to adjust the contrast of the LCD display. Press the **Up** soft key to lighten the contrast. Press the **Down** softkey to darken the contrast.

There is a keypad shortcut for increasing and decreasing contrast. While in normal display mode press the **Arrow** key and the 2nd softkey simultaneously to increase contrast. Press the **Arrow** key and first softkey simultaneously to decrease contrast.

- **Blite** - Press this key to adjust the backlight brightness and sleep timer functions.

Inten- Backlight intensity can be set to a value of 1 - 10. Default backlight value is 1.

Press **Arrow** key and **F4** simultaneously to increase intensity.

Press **Arrow** key and **F3** simultaneously to decrease intensity

Mode- Select Backlight to operate as always "On", "always Off" or the backlight can operate from a configurable "Timer".

If set to Timer, the operator will be asked to enter the Time in Seconds, after motion stops that the backlight will shut off.

The next selection will allow the user to configure if motion resets timer. Choose Yes or No to have motion reset the Timer which turns off the backlight.



Use of the backlight will affect battery life.

About:

Press this softkey to see the following information:

- **Device** - Press this softkey to show a list of information about the Quick-Check; serial number, capacity rating, hardware and software revision levels. Press any key to return to the previous softkey set.
- **Calib** - Press this softkey to show Calibration Points and the calibration information for the current wire size. Follow the on-screen prompts.
- **O. Load** - Press this softkey to show an audit count of the number of times the unit has been overloaded beyond 120% of capacity and the actual hours the unit is on (On Time). Press any key to return to the previous softkey set.
- **Zero** - Press this softkey to show the deadload analysis of the Quick-Check. Press any key to return to the previous softkey set.
- **Ntwrk** - Displays network information (Radio, Name, ID#). Future development.

Test:

Press this softkey and the following softkeys appear:

- **Batt** - Press this softkey to test the battery level.
- **A-D** - Press this softkey to display the A to D counts.
- **Disp.** - Press this softkey to perform a test of the display pixels.
- **Keys** - Press this softkey to test the keypad.
- **Comm** - Press this softkey to test the RS-232 in a loopback test (Cell). Com1 is not used.
- **Setpts** - Not used in the Quick-Check.

Clock

Enter the date and time. Use the **Num** softkeys to enter the correct number and use the **Adv** softkey to advance the cursor. When the entry is correct, press the **Enter** softkey.

Config

This is a password protected menu. See *Configuration Mode* [on page 26](#).

4 Configuration Mode

4.1 Accessing the Configuration Mode

You need to access the Configuration mode to perform certain tasks. Access to some of these tasks may be restricted by a supervisor password.

To access Configuration mode:

1. From normal operating mode, press the **Right Arrow** softkey...

A new softkey set, shown below, appears:

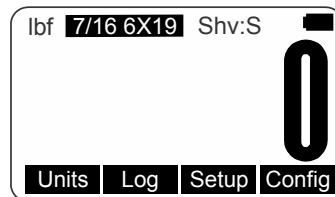

2. Press the **Config** softkey...

The following is displayed:

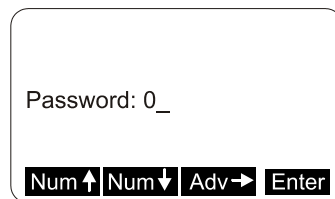

The **Num** keys increment and decrement the displayed numbers. The **Adv** key moves the cursor to the next digit position.

Default Configuration password is 0. If a new password is lost or forgotten, contact your Dillon distributor.

3. Use the **Num** and **Adv** keys to enter the Config password. Default is 0. After the number is displayed, press the **Enter** key...

The following is displayed:



4. The unit is now in the Configuration mode. To see the rest of the softkeys available in this mode, press the Right Arrow key. All the Config softkeys are shown below.

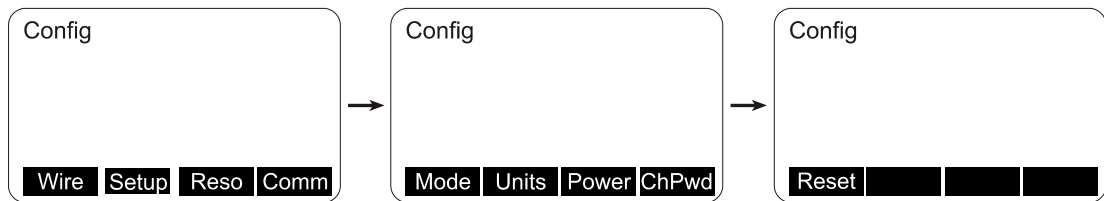

The softkeys in the Configuration mode are **Wire**, **Setup**, **Reso**, **Comm**, **Mode**, **Units**, **Power**, **ChPwd**, and **Reset**. These are described below:

Wire

Press this softkey and the wire selection screen is displayed. Choose an existing wire to change its defining characteristics.

You have the choice of changing the **Range**, which is used to set the check-tensioning function, or the **Rating**, which is the maximum rating of the cable.

- **Range** - Use this item to set the parameters for the check tensioning display. Follow the prompts to set the following:
 - Lower tension limit - This is the lowest acceptable force
 - Upper tension limit - This is the highest acceptable force
 - Units - Unit of measure used in defining the tension limit
- **Rating** - Press this softkey and you are prompted to set the ultimate rating for the cable being used and the unit of measure for that rating.

Setup

Press the **Setup** softkey to view the Setup softkeys. This is the same as the **Setup** softkey described in *Top level Softkeys* on [page 16](#).

Reso

Press the **Reso** softkey and you are prompted to enter a display, or count-by, resolution. Choose from **Low**, **Medium** or **High**.

Low resolution provides the best stability and makes the display easiest to read. High resolution provides the finest graduations, but sees greater drift from wire creep and non-repeatability. If the reading is decreasing over time or differing between measurements on the same line, lowering the resolution will reduce these effects.

Comm

Communication output (COM1) and RADIO are not supported at this time in the Quick-Check. Press the **COMM** key to select Cell.

- **Cell** - Press this key to configure the RS-232 port (4 pin Lemo)
- **COM1** - Not used
- **RADIO** - For specials and future development

Mode

Press this softkey to set the display mode on power up. Choices are **Last***, **Check**, **Avg**, **Peak**, and **Force**. Use the **Sel** keys to display your choice and press **Enter** to accept it.

Units

Press this softkey to set the following:

Unit of measure on power up - Choices are **Last***, **C2**, **C1**, **N**, **kgf**, and **lbf**. Use the **Sel** keys to display your choice and press **Enter** to accept it. C2 and C1 are custom units. If you choose to have custom units, you are prompted to enter the number of pounds in each custom unit. The Quick-Check will then automatically calculate correct display for the applied force.

- **Enable lbf** - Enable or disable the pound-force unit of measure.
- **Enable kgf** - Enable or disable the kilogram-force unit of measure.
- **Enable N** - Enable or disable the N unit of measure.
- **Enable CUST1** - Enable or disable the Cust1 unit of measure.
- **Enable CUST2** - Enable or disable the Cust2 unit of measure.



Custom units of measure are handy when working with multi-part lines.

Power

Press this softkey to set the Peak Capture Rate and enable or disable the Auto-shutdown.

Select a Peak Capture Rate using the **Sel** key to scroll through the choices. Choices are 100Hz - Normal, 1kHz - High Speed, and 10Hz - Battery Saver (default). Press **Enter** to accept the displayed setting.



Be aware that 1kHz - High Speed mode will consume more battery power.

If you enable Auto-shutdown, you are prompted to set a period of time in minutes. Next, press the **Enter** softkey to accept this value. You are then asked to set the shutdown type; **Fixed**, **No Load**, or **No Change**. These are described below;

- **Fixed** - The unit will shutdown after the set number of minutes no matter what happens.
- **No Load** - The unit will shutdown after the set number of minutes only if there is no load on the unit. This prevents shutdown in the middle of line tensioning.
- **No Change** - The unit will shutdown if there has been no keypad activity or change in tension after the set number of minutes.

ChPwd

Press this key and you are prompted to enter a new password to access the configuration menus. Use the softkeys to scroll in a new password and press the Enter softkey to accept it.



Default password is 0. If a new password is lost or forgotten, contact your Dillon distributor.

Reset

Press this key and you are asked if you wish to reset the system. Press the **Yes** softkey only if you want to reset the unit to factory default configuration. Press the **No** softkey to abort this and return to the previous screen.

5 Changing Sheaves



Do not use the Quick-Check with cable larger than indicated on the sheaves. Overload and damage to the instrument may result.

Do not mix sheave sizes. This will result in inaccurate measurement and possible overload.

As you use the Quick-Check on different diameter cables you must change to the correct sheave size. To change sheaves, remove the hex head screws pointed out in Figure 5.1 below. Replace the sheaves with the correct letter sheave and reinsert the screws and tighten.

Insure sheaves installed agree with sheaves noted in the Wire calibration.

Exception: Sheaves match the wire diameter of the cable to be measured and alternate calibration is selected as per the section *Calibration to Specific Wire Type* on [page 31](#).

Insure that the wire rope is riding in the groove of all three sheaves.

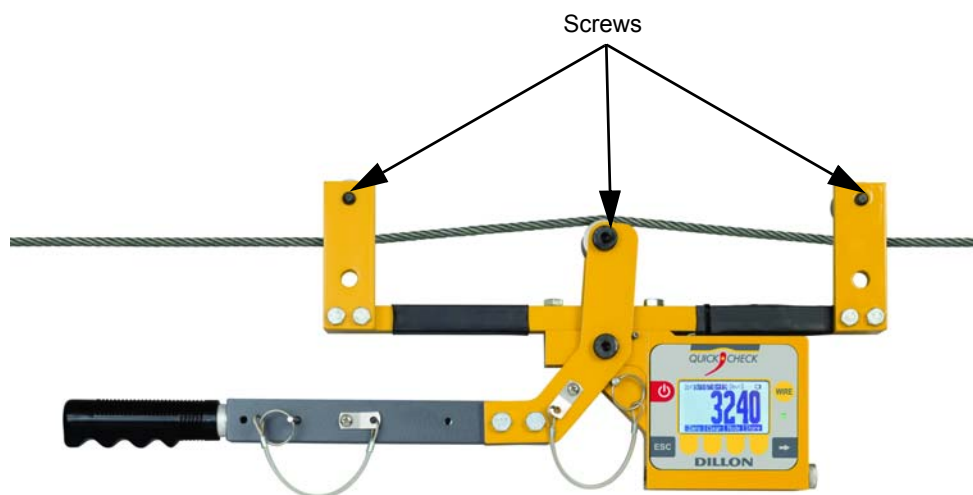

Figure 5.1 Changing Sheaves

6 Achieving Best Accuracy

6.1 Accuracy

The Quick-Check is an instrument designed to give accuracy that typically exceeds normal requirements for wire tensioning. You should have an understanding of what factors affect tension measurement accuracy.

6.2 Calibration to Specific Wire Type

While it is best to have the instrument calibrated to the specific wire size(s) and type(s) used, the Quick-check can often work adequately in other situations. If the best tension accuracy is required, Dillon recommends that a calibration be performed for that specific wire size and type.



Contact your Dillon distributor for any additional calibrations you may need.

Do not use the Quick-Check to measure tension for wires if either of the following are true:

1. No wire calibrations are stored of the same diameter as the wire you are looking to measure, and
2. You do not have sheaves of the same diameter.

If either of these conditions exist, contact your Dillon distributor.

Contact your Dillon distributor to improve accuracy for a specific wire type by calibrating to it.

6.3 Loading Error

A tensiometer works by deflecting the cable, which makes the cable path longer than when a tensiometer is not installed. When the tensiometer is removed, the wire tension decreases as the cable length is restored. This effect is known as loading error. The Quick-Check design elongates the cable by a mere 0.08 inch (2 mm), making loading errors extremely small.

6.4 Non-repeatability

The Quick-Check's sheave with bearing design provides the best mechanical performance. It is also superior at detecting tension that is being added or removed.

6.5 Non-linearity

Most three-point tension meters employ only linear characterization and have large errors at the midpoints (up to 15%). The Quick check uses multi-point segmenting to correct for non-linearity, reducing it to less than 0.2%.

6.6 Wire Characteristics

- Creep** Every material including steel exhibits creep under load. It will neck down over time, quite quickly over the first few seconds and much slower as time progresses. A wire cable also sees creep from the wire spacing and wind. This effect is seen as a display that drifts lower after it has been clamped in line.
- Variations** Material that varies in diameter or shape will have different output at the same tension
- Strands** The best cable assembly is one that is perfectly round, as it will not change contact geometry with the wire twist. The closer the wire cable cross section appears to be round, the better the measurement performance will be.

7 Troubleshooting

7.1 Quick Check

Problem	Possible Cause	Solution
Powers on momentarily and turns off	Low battery	Replace with high quality alkaline batteries
	Bad keypad	Have unit serviced
Does not power on	Low battery	Replace with high quality alkaline batteries
	Batteries installed backwards or no spring contact	Insure that positive terminals of both batteries (nub) face inward – towards the black cap. Check that spring is attached to the battery cap.
	Software reset	Remove battery cap & reinstall after one minute. Attempt to turn power on again.
	Display contrast too light	Hold the Right Arrow key down while pressing the F2 key several times to increase the display contrast. If nothing occurs, release both keys. Press the power button and try again.
	Bad keypad	Have unit serviced
Display is completely dark	Display contrast too dark	Hold the Arrow key down while pressing the F1 key several times to decrease the display contrast.
Display drifts downward once installed	Wire material is creeping and internal friction between wires is relieved.	This is normal behavior of wire. Lower display resolution to mask this effect.

7.2 EDX PSU

Problem	Possible Cause	Solution
Quick Check powers on momentarily and turns off	Low battery	Replace with high quality alkaline batteries. Do not use rechargeable batteries.
	Bad keypad	Have unit serviced.
Quick Check does not power on	Low battery	Replace with high quality alkaline batteries. Do not use rechargeable batteries.
	Bad keypad	Have unit serviced.
	Batteries installed backwards or no spring contact	Insure that positive terminals of both batteries (nub) face inward – towards the black cap. Check that spring is attached to the battery cap.
	Software reset	Remove battery cap & reinstall after one minute. Attempt to turn power on again.
	Display contrast too light	Hold the Right Arrow key down while pressing the F2 key several times to increase the display contrast. If nothing occurs, release both keys. Press the power button and try again.
	EDX PSU Power Supply	Remove Power Supply and install batteries to see if the Quick Check or Communicator II will power up. Return EDX PSU to factory for repair/troubleshooting.
Display is completely dark	Display contrast too dark	Hold the Arrow key down while pressing the F1 key several times to decrease the display contrast.
Quick Check does not appear accurate	Check installation & system	Insure that shackles are in good working condition and aligned straight. Verify system is applying force directly through the dynamometer with no off center or torsional loads being applied to the instrument.
	Local gravitational variances	If being compared against dead-weights, check your local gravitational constant. Use custom units to compensate or calibrate on-site.
	Check repeatability	Place Quick Check in low-resolution mode. Lift an arbitrary weight several times as close to capacity as possible. Record each weight reading. Do the readings differ from each other? Calculate the standard deviation of the readings using a spreadsheet such as Microsoft Excel. See if the deviation is greater than 0.1% of the instrument capacity.
	Compare against a reference load.	Place Quick Check in low-resolution mode. Apply a known load near instrument capacity. Check calibration date.
Radio communications not working at all	Dead batteries. Distance is excessive, dead radio pocket	Bring remote closer to dynamometer. Allow several seconds to retrain.
	Operating channels mismatched	Remote and link must be on the same operating channel. See Quick Check and Communicator configurations of COM1 for radio (under Comm menu) and Common Configurations.
	Excessive radio noise or interference in environment	Remove dynamometer and Communicator from the environment. Attempt communications in an area free of local radio signals. See Radio Information section of the manual.
Remote reading changes to dashes	Low batteries, lost communications	See steps above for improving communications.
Display locks up on DILLON marquee	Poor connection between Quick Check and Communicator	Remove batteries from Quick Check and Communicator, replace them and power up.

8 Specifications

Power

2 AA, common alkaline batteries.

Display

Dot graphic LCD display

Operational Keys

Power, Wire, Escape/Clear (ESC), Next () and four softkeys with changing function and label, depending on the specific menu in use

Operational Annunciators

Unit of measure, battery level

Display Resolution

2,000 lbf/ 10 kN/ 1000 kgf Quick-Check instrument:

	Displayed resolution setting		
	Low	Med	High
lbf (pound-force)	10 lbf	5 lbf	2 lbf
kgf (kilogram-force)	5 kgf	2 kgf	1 kgf
N (Newton)	50 N	20 N	10 N
Custom units	between 101 & 200 divisions	between 201 & 500 divisions	between 501 & 1000 divisions

10,000 lbf/ 45 kN/ 4500 kgf Quick-Check instrument:

	Displayed resolution setting		
	Low	Med	High
lbf (pound-force)	50 lbf	20 lbf	10 lbf
kgf (kilogram-force)	20 kgf	10 kgf	5 kgf
N (Newton)	200 N	100 N	50 N
Custom units	between 101 & 200 divisions	between 201 & 500 divisions	between 501 & 1000 divisions

For ease of use, the display always counts by a multiple of 1, 2 or 5.

Available Options

Varied wire sizes

Operating Environment

Suitable for outdoor use

Dimensions

10" x 23" x 3" (25 cm x 59 cm x 8 cm) approximately

Weight

11 lb (5 kg) approximately

8.1 EDX PSU Power Supply Specifications

Enclosure	Designed for indoor use
Input Voltage	100-240 VAC 50-60Hz, 0.55A
Output Voltage	5 VDC
Operating Temperature	-4 F to 158 F (20 to 70 C)
Connector	Sealed connector to be used with Quick Check
Approval	CE