

# IT8400

## High Performance DC Electronic Load



*Your Power Testing Solution*

# IT8400 High performance DC electronic load

Fast double power loading < 3s

25kHz dynamic loading available for 1200V models

3 current ranges, max.40uA resolution



IT8400 high-performance DC electronic load has two voltage levels, 600V and 1200V. It supports master-slave connection in parallel with power from 6 kW to 600 kW, and is capable of fast double power loading. It has three current readback ranges with a resolution of up to 40uA. IT8400 has faster loop response and current rising and falling speed. It supports up to 8 working modes. It also has dynamic mode, List, OCP, OPP test, automatic test and battery test functions. IT8400 has built-in CAN, LAN, GPIB, USB, RS232 and analog interfaces, suitable for remote control and system building. In addition, the full protection function makes it well matched with the test of fuel cell, power battery discharge, DC charging pile, BOC, power electronics, solar, automotive high-voltage components, DC-DC, motor and so on.

## FEATURE

- Max.Voltage : 1200V
- Current range: 1.5A~15,000 A
- Power extended to 600 kW through master-slave connection in parallel
- High-precision three current measurement ranges with resolution up to 40uA
- Fast double power loading capability (<3 s)
- 25kHz fast dynamic mode, current rising and falling time is adjustable
- Provide 8 working modes: CC, CV, CR, CP, CC+CV, CV+CR,CR+CC, CP+CC
- 1 kHz continuous sampling rate
- List programming
- The battery discharge function is used to test energy storage devices such as batteries and super capacitors
- CV loop speed is adjustable to match different power supplies
- 500 kHz voltage and current sampling rate
- Time measurement, OCP/OPP test short circuit simulation, automatic test
- Soft start and soft shutdown to prevent voltage fluctuations during on/off
- I-monitor function
- Full protection: OVP, UVP, OCP, OPP, OTP, current oscillation protection, current limit, power limit, reverse alarm, etc.
- Power-off retention memory function, recording up to 100 groups data
- Independent control, easy to maintain and install.
- Built-in standard LAN, USB, RS232, GPIB, CAN and analog, IO interface
- LabVIEW driver and SCPI protocol

# Your Power Testing Solution

IT8400 High performance DC electronic load

Input	600V	1200V	Height
6 kW	IT8406-600-150	IT8406-1200-75	4u
12 kW	IT8412-600-300	IT8412-1200-150	8u
18 kW	IT8418-600-450	IT8418-1200-225	15u
24 kW	IT8424-600-600	IT8424-1200-300	27u
30 kW	IT8430-600-750	IT8430-1200-375	27u

Input	600V	1200V	Height
36 kW	IT8436-600-900	IT8436-1200-450	27u
42 kW	IT8442-600-1050	IT8442-1200-525	37u
48 kW	IT8448-600-1200	IT8448-1200-600	37u
54 kW	IT8454-600-1350	IT8454-1200-675	37u

\* This information is subject to change without notice

## Application

### Automotive electronics

DC charging station, OBC, DC-DC, generator, motor, fuse, relay, MCU, power electronics devices, sensor.



### Energy storage

Battery, fuel cell, super capacity



### Solar

PV modules, power optimizer



### Electric and electronics devices

UPS, motor, power semiconductor

## Fast loading with double power

The input voltage of IT8400 DC electronic load can reach 1200V. It has a fast double power loading capacity and is available for all models from 6kW to 600kW. You do not need to select the model according to the maximum power during the actual test, which can greatly save your costs.

The input over power and loading time are relevant with the temperature of the electronic load. For example: below 30 °C, IT8400 supports double power loading within 3 seconds. This makes it suitable for instantaneous high-power discharge tests of motors and batteries. For example, simulating the starting of a DC motor, simulating the transient overload characteristics of some power supplies, or instantaneously discharging a high-power battery or fuel cell.

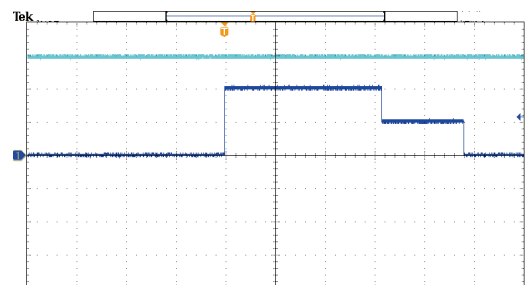

# Your Power Testing Solution

IT8400 High performance DC electronic load

## AC impedance test of fuel cells

IT8400 can be used to check the output impedance of fuel cells. Wire according to the figure below, it should be noted that:

1. Use 4-wire Kelvin wiring to more accurately measure fuel cell output voltage and eliminate voltage drops on power lines. A two-wire system can measure lower voltages.
2. Twist the remote Sense wires together (twisted pair) and separate them from the source leads to reduce noise inductive coupling in the sense wires.
3. Keep the test lines as short as possible to reduce transmission line ringing in case a step load change occurs.

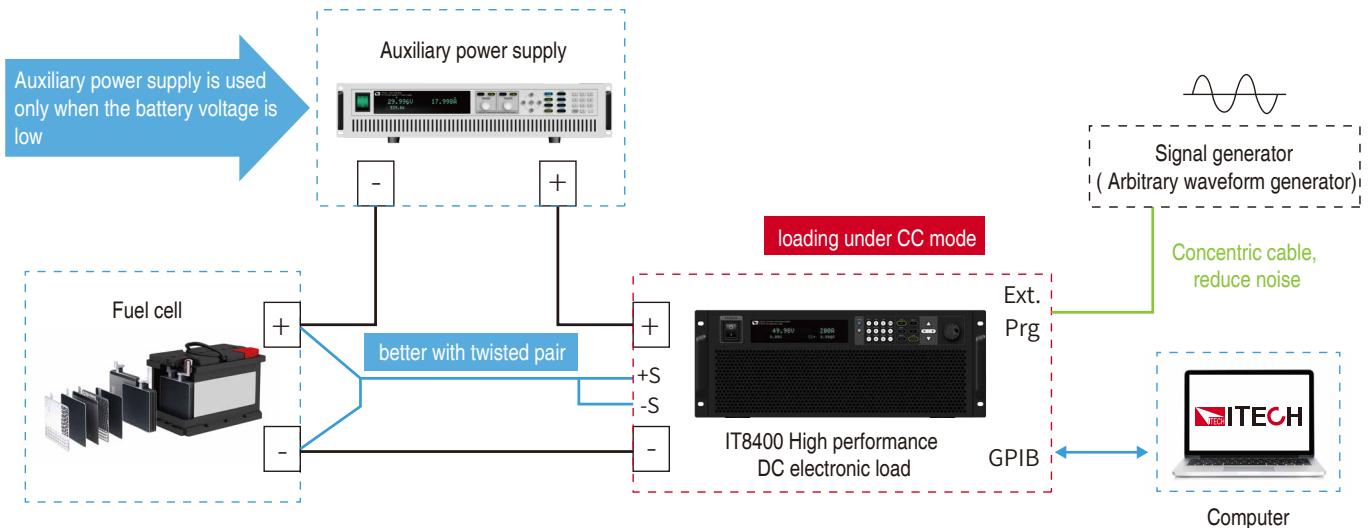

## Higher current rise and fall speed and dynamic speed

Dynamic testing is one of the necessary test items for power supplies. The dynamic mode of IT8400 can be used to measure it. Set the current level, time, rising and falling slope and repeat times, and then you can check if the power supply still works stably when the load current is changed stepwise.

IT8400 supports the programmable dynamic loading mode with 25kHz. The minimum current rise and fall time is 15us. When the loading current changes continuously, the internal monitoring and circuit can minimize the current waveform distortion. So it is well used for transient response test of switching power supply and dynamic discharge test of battery.

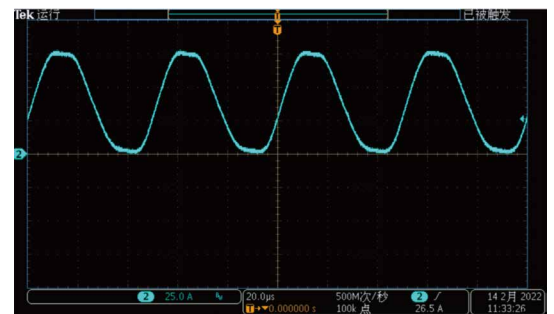

IT8400-1200-75  
20kHz, 0A-75A

## Multiple built-in communication interfaces

IT8400 DC electronic load has built-in standard LAN, USB, RS232, CAN, GPIB, analog interfaces. It also provides Labview driver and free software IT9000. In addition, it supports SCPI protocol.

It is available for power extension, computer or PLC remote control, system building etc.



# Your Power Testing Solution

IT8400 High performance DC electronic load

## 3 Current measurement range

All models of IT8400 series have 3 current measurement ranges. For example, the 1200V, 6kW model, its current can reach 1.5A. In addition, the high resolution (40uA at most ) and high accuracy (1.5mA at most ) enable it to be widely used in the tests such as solar, power semiconductor devices, automotive electronics and so on.

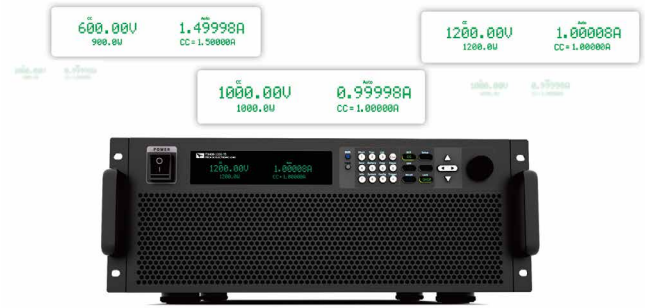

## 8 Working modes

IT8400 series provides eight kinds of working modes such as CC, CV, CR, CP, CV+CC, CV+CR, CR+CC, CP+CC, which can adapt to the test requirements of various occasions. Among them, the CP mode is often used to UPS battery test, simulate the current change when the battery voltage is decaying. It can also be used to simulate the characteristics of the inputs of DC-DC converters and inverters. The CV+CC mode can be applied to the load simulation battery and test the charging station or the car charger. When the CV is working, the maximum loading current is limited. CR+CC mode is commonly used in the testing of voltage limiting, current limiting characteristics, constant voltage accuracy, and constant current accuracy of on-board chargers, which

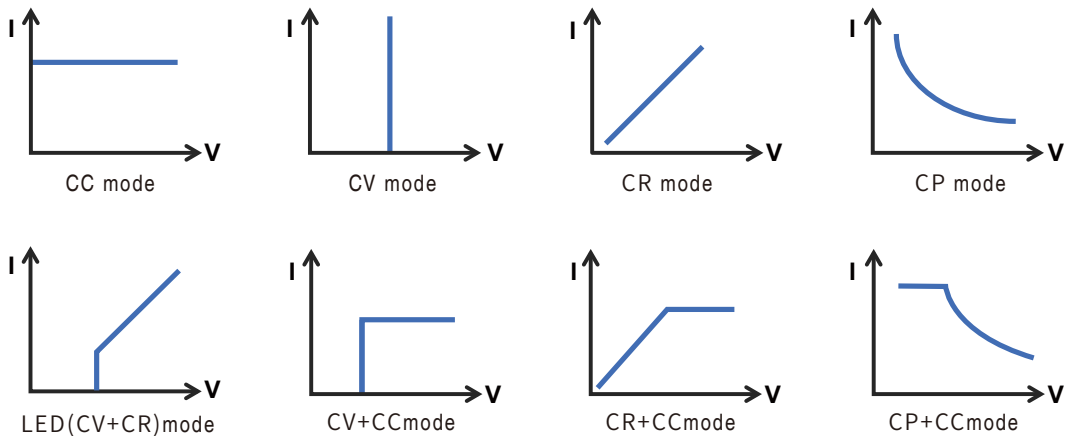

## Application

### Test of charging station

In the charging station test, when the load works under CV mode and has reached 700V gradually, because the current increases faster (in order to make the load quickly stabilize at 700V), it is easy to trigger overshoot current protection of the charging station.

At this time, we can set the I-limit in the CV+CC mode to make sure that the internal current won't exceed the overshoot value, which can effectively deal with the above issue.

### CV+CC mode (I-limit)

No current overshoot

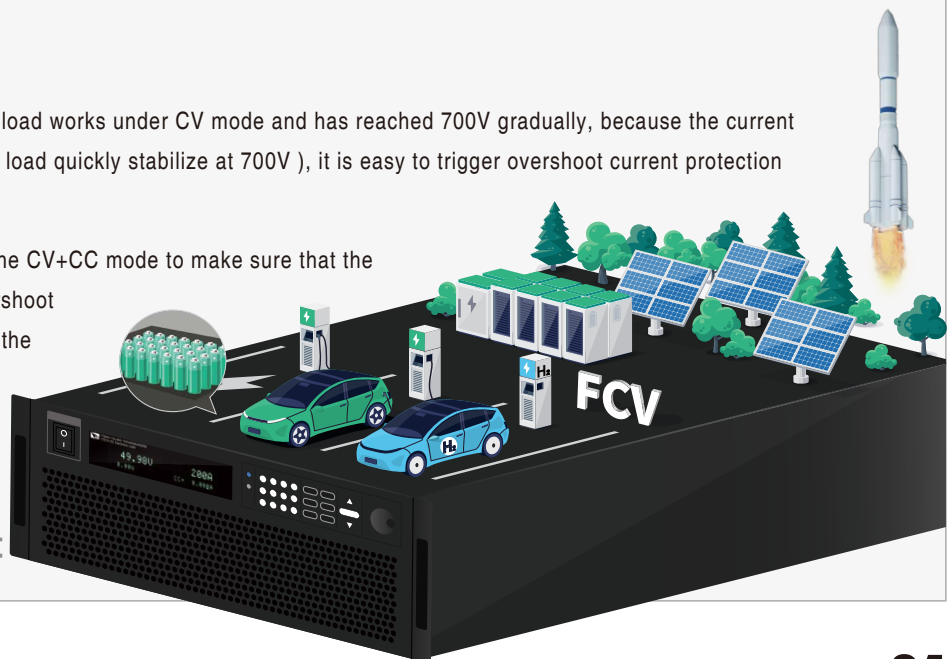

# Your Power Testing Solution

IT8400 High performance DC electronic load

## List function

Testing of power supplies or batteries often requires complex simulations of operating conditions with different loading currents. The List mode of IT8400 can help to realize it.

In addition, IT8400 DC electronic load also allows programming by both front panel and computer. It synchronizes the triggering of internal or external signals, which makes it easy for system integration and remote control.

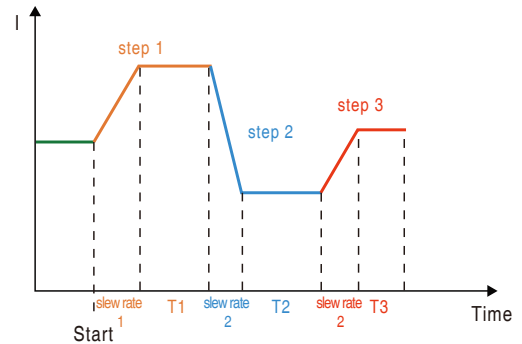
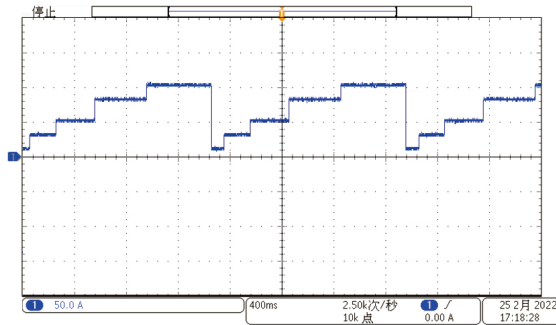

## OCP, OPP Tests

OCP and OPP are mainly applied in over-current and over-power point tests of the lithium-battery protection board and power modules. For power supplies, OCP and OPP are designed to guarantee the user's safety and to reduce damage rate.

IT8400 DC electronic load can automatically judge the test result according to the set specifications, so the users can save much time in verification of design and production system.

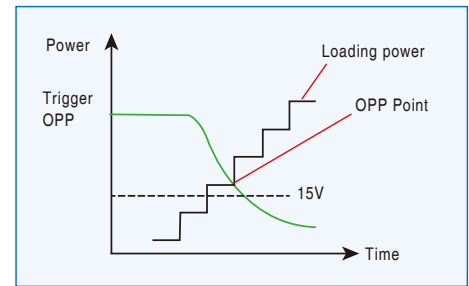

## 10kHz analog

IT8400 series electronic load has analog control interface, which can be used for industrial control or parallel Expand load power usage.

When used for industrial control, use the 0~10V output from PLC to control the 0~100% full-scale change of the load. Compared with the real-time control of the host computer, the response time is faster, up to 10 $\mu$ s, the single step time is less than 10ms, and the accuracy is acceptable. up to 1%. At the same time, it also has the advantage of unlimited steps. It can be used for battery testing of various complex waveforms, and also for impedance analysis of fuel cells test.

When used for parallel expansion of load power, the analog interface can be used for parallel differential analog control

Compared with the traditional independent LAN port parallel communication, the data is more stable and reliable.

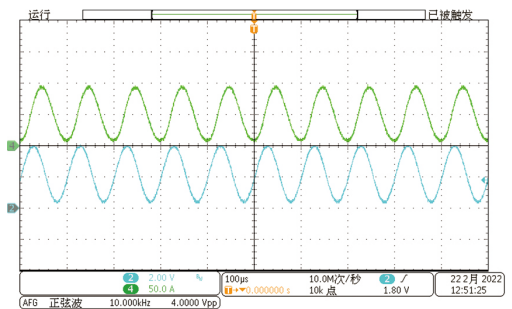

## Full protections

To avoid instrument damages by incorrect operations or abnormal ambient surroundings, IT8400 provides OVP, OCP, OPP, over heat protection, anti-reverse protection, current limit protection, power limit protection, and etc. When abnormal, IT8400 will immediately stop working to ensure the DUT safety.



### Master-slave paralleling, flexible power configuration

IT8400 series supports master-slave connection in parallel and equalized current. It also supports parallel connection between the units with different power and same voltage. After paralleling connection, all functions of the stand-alone can be realized, including working in CV mode, maximum paralleling up to 600kW. The stand-alone can also work independently and the power configuration is more flexible. It adopts analog and digital wiring separately, which ensure the stable performance of the units.

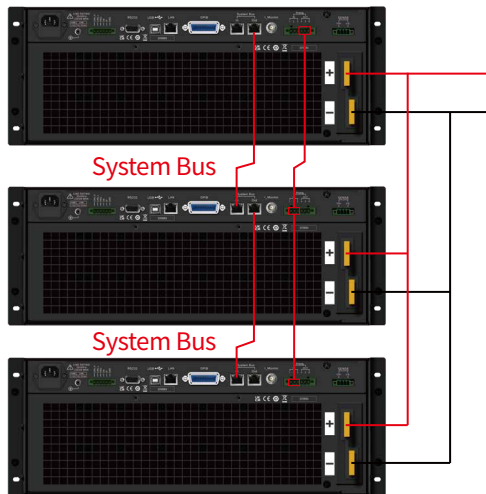

Master-slave parallel connection, current equalized  
Power extended to 600kW

Multiple working modes after parallel connection  
Stay good performance

Analog and digital wiring separately  
Stable

Parallel connection between the units with different power  
and same voltage  
Flexible power extension

### Battery discharge function

IT8400 DC electronic load has battery discharge function, and can perform discharge test under CC, CR, or CP mode. IT8400 can set 3 battery cut-off conditions: voltage, capacity and time. Whenever met any condition, it will automatically stop test. During the test, the battery's voltage, time and already-discharged-capacity can be checked. It can be used in the battery life and reliability test.

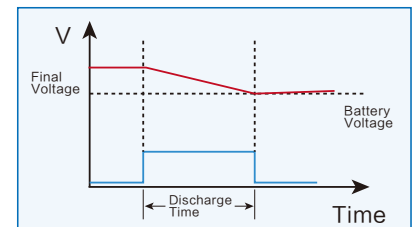
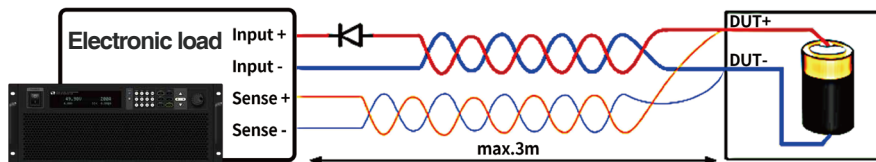

### Battery discharge function

DUT: Lithium-ion battery, battery, fuel cell, super capacity

Advantages:

- Power ranges from 6kW to 600kW, voltage 600V/1200V
  - Power extended in parallel connection
  - Battery discharge cut-off condition: voltage, capacity, time, help to analyze the decay of battery capacity
  - List programming and analog help to simulate multiple waveforms
  - 25kHz dynamic response, fast current rise and fall
  - Analog dynamic response with 10kHz, no limit for steps, the dynamic loading is good for AC impedance test of fuel cell
  - 10kHz continuous V-I sampling for battery discharging
- Built-in GPIB, LAN, USB, CAN interface, support SCPI, LabVIEW, can be equipped with ITS5300 battery test system



# Your Power Testing Solution

IT8400 High performance DC electronic load

Model		IT8406-600-150		
Rated (0-40 C)	Voltage	0-600V		
	Current	3A	15A	150A
	Power	1.8KW	6kW	
	Minimum operating voltage	0.45V@3A	0.525V@15A	5.25V@150A
CV Mode	Range	0-60V		
	Resolution	1mV	10mV	
	Accuracy	±(0.05%+0.05%FS)		
CC Mode	Range	0-3A	0-15A	0-150A
	Resolution	0.1mA	0.5mA	5mA
	Accuracy	±(0.05%+0.1%FS)		±(0.05%+0.05%FS)
CR Mode <sup>3</sup>	Range	0.035Ω-10Ω		10Ω-7.5KΩ
	Resolution	16bit		
	Accuracy	0.01%+0.08S <sup>*2</sup>		0.01%+0.0008S
CP Mode <sup>3</sup>	Range	6KW		
	Resolution	0.1W		
	Accuracy	0.2%+0.2%FS		
Dynamic mode				
Dynamic Mode CC Mode <sup>4</sup>	T1 & T2	20uS-3600S /Res:1 us/10ms/100ms		
	Accuracy	5uS±100ppm		
	Rising/falling slope	0.0001-0.1A/uS	0.0005-0.75A/uS	0.005-10 A/uS
	Minimum rising time <sup>5</sup>	≈30uS	≈20uS	≈15uS
Measuring range				
Readback Voltage	Range	0-60V		0-600V
	Resolution	1mV		10mV
	Accuracy	±(0.025%+0.025%FS)		±(0.025%+0.025%FS)
Readback Current	Range	0-3A	0-15A	0-150A
	Resolution	0.1mA	0.5mA	5mA
	Accuracy	±(0.05%+0.1%FS)		±(0.05%+0.05%FS)
Readback Power <sup>2</sup>	Range	6KW		
	Resolution	0.1W		
	Accuracy	±(0.2%+0.2%FS)		
保护范围				
OPP		1.89KW	≈6.05KW	
OCP		≈3.15A	≈15.75A	≈157.5A
OVP			≈630V	
OTP			≈85 C	
Specifications				
Short Circuit	Current (CC)	≈3.15A	≈15.75A	≈157.5A
	Voltage (CV)	≈0V		
	Resistance (CR)	≈150mΩ	≈35mΩ	
Input Terminal Impedance		≈1MΩ		
Height		4U		
Weight		40 kg		
AC Input	Voltage	100-240Vac		
	Frequency	50/60Hz		
	Power	250VA max		

\*1 Voltage/Current is not less than 10%FS (FS is full range)

\*2 Readback resistance range:  $(1/(1/R+(1/R)*0.01%+0.08), 1/(1/R-(1/R)*0.01%-0.08))$

\*3 Voltage/Current is not less than 10%FS

\*4 Loading current value is not less than 4%FS\_CCH

\*5 Loading current is not less than 10%FS\_CCH



# Your Power Testing Solution

IT8400 High performance DC electronic load

Model		IT8406-1200-75		
Rated (0~40 C)	Voltage	0~1200V		
	Current	1.5A	7.5A	75A
	Power	1.8KW	6kW	
	Minimum operating voltage	1.31V@1.5A	1.5V@7.5A	15V@75A
CV Mode	Range	0.1~120V		0.1~1200V
	Resolution	10mV		100mV
	Accuracy	±(0.05%+0.05%FS)		±(0.05%+0.05%FS)
CC Mode	Range	1.5A	7.5A	75A
	Resolution	40uA	0.2mA	2mA
	Accuracy	0.05%+0.1%FS	0.05%+0.05%FS	0.05%+0.05%FS
CR Mode <sup>3</sup>	Range	0.2Ω~10Ω		10Ω~7.5KΩ
	Resolution	16bit		
	Accuracy	0.01%+0.08S <sup>*2</sup>		0.01%+0.0008S
CP Mode <sup>3</sup>	Range	6KW		
	Resolution	0.1W		
	Accuracy	0.2%+0.2%FS		
Dynamic mode				
Dynamic Mode CC Mode <sup>4</sup>	T1 & T2	20uS~3600S /Res:1 us/10ms/100ms		
	Accuracy	5uS±100ppm		
	Rising/falling slope	0.00004~0.05A/uS	0.0002~0.3A/uS	0.002~5A/uS
	Minimum rising time <sup>5</sup>	≈30uS	≈25uS	≈15uS
Measuring range				
Readback Voltage	Range	0~120V		0~1200V
	Resolution	10mV		100mV
	Accuracy	±(0.025%+0.025%FS)		±(0.025%+0.025%FS)
Readback Current	Range	1.5A	7.5A	75A
	Resolution	40uA	0.2mA	2mA
	Accuracy	0.05%+0.1%FS	0.05%+0.05%FS	0.05%+0.05%FS
Readback Power <sup>2</sup>	Range	6KW		
	Resolution	0.1W		
	Accuracy	±(0.2%+0.2%FS)		
保护范围				
OPP		≈1.89KW	≈6.05KW	≈6.05KW
OCP		≈1.575A	≈7.875A	≈78.75A
OVP			≈1250V	
OTP			≈85℃	
Specifications				
Short Circuit	Current (CC)	≈1.575A	≈7.875A	≈78.75A
	Voltage (CV)	≈0V		≈0V
	Resistance (CR)	≈875mΩ	≈200mΩ	
Input Terminal Impedance		≈1.6MΩ		
Height		4U		
Weight		40 kg		
AC Input	Voltage	100~240Vac		
	Frequency	50/60Hz		
	Power	250VA max		

\*1 Voltage/Current is not less than 10%FS (FS is full range)

\*2 Readback resistance range:  $(1/(1/R+(1/R)*0.01%+0.08), 1/(1/R-(1/R)*0.01%-0.08))$

\*3 Voltage/Current is not less than 10%FS

\*4 Loading current value is not less than 4%FS\_CCH

\*5 Loading current is not less than 10%FS\_CCH

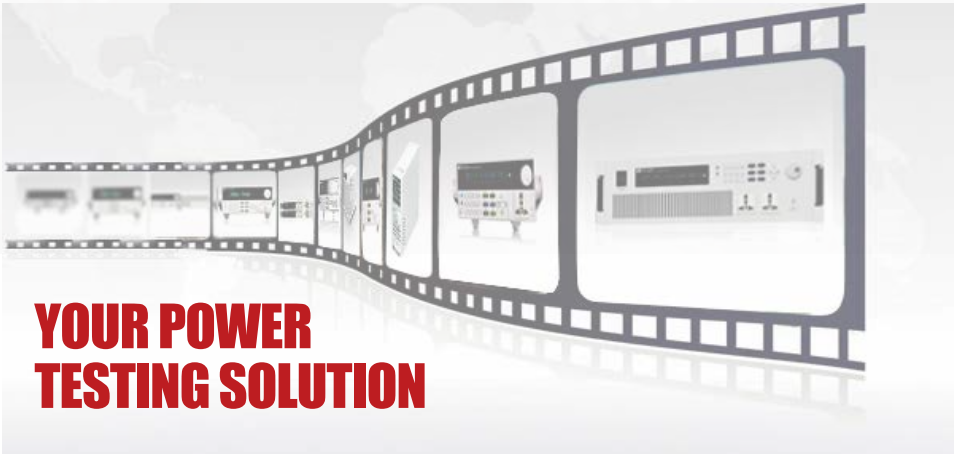
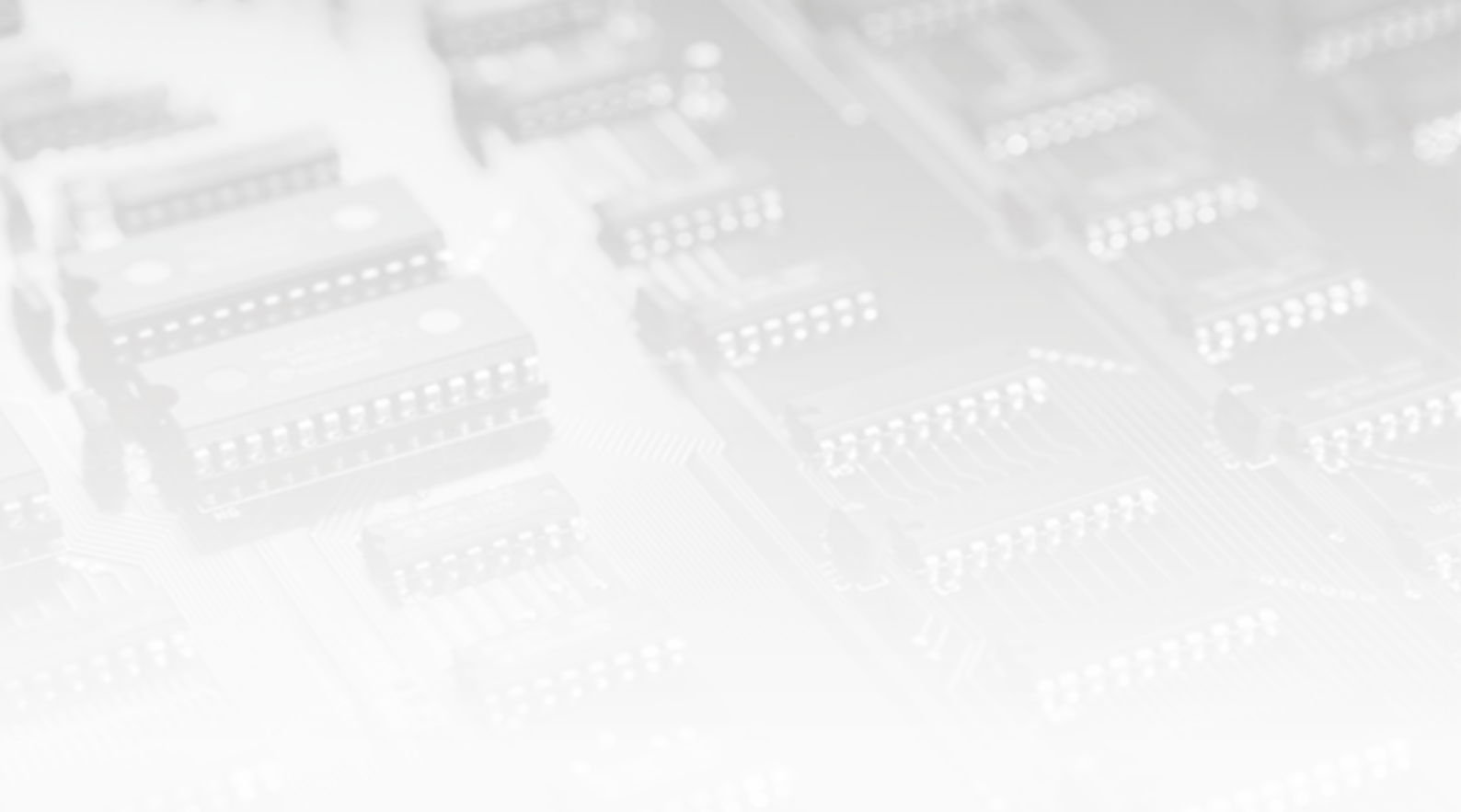

This information is subject to change without notice. For more information, please contact ITECH.

### Taipei

Add: No.918, Zhongzheng Rd., Zhonghe Dist., New Taipei City  
235, Taiwan  
Web: [www.itechate.com](http://www.itechate.com)  
TEL: +886-3-6684333  
E-mail: [info@itechate.com](mailto:info@itechate.com)

### Factory I

Add: No.108, XiShanqiao Nanlu, Nanjing city, 210039, China  
TEL: +86-25-52415098  
Web: [www.itechate.com](http://www.itechate.com)

### Factory II

Add: No.150, Yaonanlu, Meishan Cun, Nanjing city, 210039, China  
TEL: +86-25-52415099  
Web: [www.itechate.com](http://www.itechate.com)



ITECH Web



ITECH Facebook



ITECH LinkedIn