

Internal Resistance Tester

IT5102 Series User Manual



Model: IT5102/IT5102E

Version: V2.0

Notices

© Itech Electronic, Co., Ltd. 2020
No part of this manual may be reproduced in any form or by any means (including electronic storage and retrieval or translation into a foreign language) without prior permission and written consent from Itech Electronic, Co., Ltd. as governed by international copyright laws.

Manual Part Number

IT5102-402530

Revision

1st Edition: June 25, 2020

Itech Electronic, Co., Ltd.

Trademarks

Pentium is U.S. registered trademarks of Intel Corporation.

Microsoft, Visual Studio, Windows and MS Windows are registered trademarks of Microsoft Corporation in the United States and/or other countries and regions.

Warranty

The materials contained in this document are provided “as is”, and is subject to change, without prior notice, in future editions. Further, to the maximum extent permitted by applicable laws, ITECH disclaims all warrants, either express or implied, with regard to this manual and any information contained herein, including but not limited to the implied warranties of merchantability and fitness for a particular purpose. ITECH shall not be held liable for errors or for incidental or indirect damages in connection with the furnishing, use or application of this document or of any information contained herein. Should ITECH and the user enter into a separate written agreement with warranty terms covering the materials in this document that conflict with these terms, the warranty terms in the separate agreement shall prevail.

Technology Licenses

The hardware and/or software described herein are furnished under a license and may be used or copied only in accordance with the terms of such license.

Restricted Rights Legend

Restricted permissions of the U.S. government. Permissions for software and technical data which are authorized to the U.S. Government only include those for custom provision to end users. ITECH provides this customary commercial license in software and technical data pursuant to FAR 12.211 (Technical Data) and 12.212 (Computer Software) and, for the Department of Defense, DFARS 252.227-7015 (Technical Data – Commercial Items) and DFARS 227.7202-3 (Rights in Commercial Computer Software or Computer Software Documentation).

Safety Notices

CAUTION

A CAUTION sign denotes a hazard. It calls attention to an operating procedure or practice that, if not correctly performed or adhered to, could result in damage to the product or loss of important data. Do not proceed beyond a CAUTION sign until the indicated conditions are fully understood and met.

WARNING

A WARNING sign denotes a hazard. It calls attention to an operating procedure or practice that, if not correctly performed or adhered to, could result in personal injury or death. Do not proceed beyond a WARNING sign until the indicated conditions are fully understood and met.



NOTE

A NOTE sign denotes important hint. It calls attention to tips or supplementary information that is essential for users to refer to.

Quality Certification and Assurance

We certify that IT5102 internal resistance tester meets all the published specifications at time of shipment from the factory.

Warranty

ITECH warrants that the product will be free from defects in material and workmanship under normal use for a period of one (1) year from the date of delivery (except those described in the Limitation of Warranty below).

For warranty service or repair, the product must be returned to a service center designated by ITECH.















- The product returned to ITECH for warranty service must be shipped PREPAID. And ITECH will pay for return of the product to customer.
- If the product is returned to ITECH for warranty service from overseas, all the freights, duties and other taxes shall be on the account of customer.

Limitation of Warranty

This Warranty will be rendered invalid if the product is:

- Damaged resulting from customer-wired circuits or customer-supplied parts or accessories;
- Modified or repaired by customer without authorization;
- Damaged resulting from customer-wired circuits or use in an environment not designated by us;
- The product model or serial number is altered, deleted, removed or made illegible by customer;
- Damaged as a result of accidents, including but not limited to lightning, moisture, fire, improper use or negligence.

Safety Symbols

	Direct current		ON (power)
	Alternating current		OFF (power)
	Both direct and alternating current		Power-on state
	Chassis (earth ground) symbol.		Power-off state
	Earth (ground) terminal		Reference terminal
	Caution		Positive terminal
	Warning (refer to this manual for specific Warning or Caution information)		Negative terminal

	A chassis terminal	-	-
---	--------------------	---	---

Safety Precautions

The following safety precautions must be observed during all phases of operation of this instrument. Failure to comply with these precautions or specific warnings elsewhere in this manual will constitute a default under safety standards of design, manufacture and intended use of the instrument. ITECH assumes no liability for the customer's failure to comply with these precautions.

WARNING

- Do not use the instrument if it is damaged. Before operation, check the casing to see whether it cracks. Do not operate the instrument in the presence of inflammable gasses, vapors or dusts.
- The internal resistance tester is provided with a three-core power line during delivery and should be connected to three-core junction box. Before operation, be sure that the internal resistance tester is well grounded. Make sure to use the power cord supplied by ITECH.
- Check all marks on the instrument before connecting the instrument to power supply.
- Use electric wires of appropriate load. All loading wires should be capable of bearing maximum short-circuit of electronic load without overheating. If there are multiple loads, each pair of the load power cord must be carry out the full rated short-circuit output current of the power securely.
- Ensure the voltage fluctuation of mains supply is less than 10% of the working voltage range in order to reduce risks of fire and electric shock.
- Do not install alternative parts on the instrument or perform any unauthorized modification.
- Do not use the instrument if the detachable cover is removed or loosen.
- To prevent the possibility of accidental injuries, be sure to use the power adapter supplied by the manufacturer only.
- We do not accept responsibility for any direct or indirect financial damage or loss of profit that might occur when using the instrument.
- This instrument is used for industrial purposes. Do not apply this product to IT power supply system.
- Never use the instrument with a life-support system or any other equipment subject to safety requirements.

CAUTION

- Failure to use the instrument as directed by the manufacturer may render its protective features void.
- Always clean the casing with a dry cloth. Do not clean the internals.
- Make sure the vent hole is always unblocked.

Environmental Conditions

The instrument is designed for indoor use and an area with low condensation.

The table below shows the general environmental requirements for the instrument.



Environmental Conditions	Requirements
Operating temperature	0°C to 40°C
Operating humidity	20%-80% (non-condensation)
Storage temperature	-20°C to 70 °C
Altitude	Operating up to 2,000 meters
Installation category	II
Pollution degree	Pollution degree 2



Note

To make accurate measurements, allow the instrument to warm up for 30 min.

Regulatory Markings

	<p>The CE mark indicates that the product complies with all the relevant European legal directives. The specific year (if any) affixed refers to the year when the design was approved.</p>
	<p>The instrument complies with the WEEE Directive (2002/96/EC) marking requirement. This affix product label indicates that you must not discard the electrical/electronic product in domestic household waste.</p>
	<p>This symbol indicates the time period during which no hazardous or toxic substances are expected to leak or deteriorate during normal use. The expected useful life of the product is 10 years. The product can be used safely during the 10-year Environment Friendly Use Period (EFUP). Upon expiration of the EFUP, the product must be immediately recycled.</p>

Waste Electrical and Electronic Equipment (WEEE) Directive



2002/96/EC Waste Electrical and Electronic Equipment (WEEE) Directive

This product complies with the WEEE Directive (2002/96/EC) marking requirement. This affix product label indicates that you must not discard the electrical/electronic product in domestic household waste.

Product Category

With reference to the equipment classifications described in the Annex 1 of the WEEE Directive, this instrument is classified as a "Monitoring and Control Instrument".

To return this unwanted instrument, contact your nearest ITECH office.

Compliance Information

Complies with the essential requirements of the following applicable European Directives, and carries the CE marking accordingly:

- Electromagnetic Compatibility (EMC) Directive 2014/30/EU
- Low-Voltage Directive (Safety) 2014/35/EU

Conforms with the following product standards:

EMC Standard

IEC 61326-1:2012/ EN 61326-1:2013 ¹²³

Reference Standards

CISPR 11:2009+A1:2010/ EN 55011:2009+A1:2010 (Group 1, Class A)

IEC 61000-4-2:2008/ EN 61000-4-2:2009

IEC 61000-4-3:2006+A1:2007+A2:2010/ EN 61000-4-3:2006+A1:2008+A2:2010

IEC 61000-4-4:2004+A1:2010/ EN 61000-4-4:2004+A1:2010

IEC 61000-4-5:2005/ EN 61000-4-5:2006

IEC 61000-4-6:2008/ EN 61000-4-6:2009

IEC 61000-4-11:2004/ EN 61000-4-11:2004

1. The product is intended for use in non-residential/non-domestic environments. Use of the product in residential/domestic environments may cause electromagnetic interference.
2. Connection of the instrument to a test object may produce radiations beyond the specified limit.
3. Use high-performance shielded interface cable to ensure conformity with the EMC standards listed above.

Safety Standard

IEC 61010-1:2010/ EN 61010-1:2010

Content

Quality Certification and Assurance.....	3
Warranty.....	3
Limitation of Warranty.....	3
Safety Symbols.....	3
Safety Precautions.....	4
Environmental Conditions.....	4
Regulatory Markings.....	5
Waste Electrical and Electronic Equipment (WEEE) Directive.....	5
Compliance Information.....	6
Chapter1 Inspection and Installation	1
1.1 Verifying the Shipment.....	1
1.2 Instrument Size Introduction.....	1
1.3 Dimension.....	1
1.4 Adjusting the Handle.....	3
1.5 Removing the Handle.....	3
1.6 Rack Mounting.....	4
1.7 Connecting the Power Cord.....	4
Chapter2 Quick Start.....	5
2.1 Brief Introduction.....	5
2.2 Features.....	5
2.3 Front Panel Introduction.....	5
2.4 Screen Indicator Lamps Description.....	7
2.5 Rear Panel Introduction.....	7
2.6 Power-on Selftest.....	8
Chapter3 Function and Features	11
3.1 System Menu.....	11
3.1.1 Switch measurement between the front and rear panels.....	12
3.1.2 Extension channels for Master and Slave connection.....	13
3.1.3 Range setting.....	15
3.1.4 Measurement frequency setting.....	16
3.1.5 Filter function setting.....	16
3.1.6 Initializing menu items.....	17
3.1.7 Buzzer setting.....	17
3.1.8 Alarm setting.....	18
3.1.9 Communication setting.....	18
3.1.10 Instrument information checking.....	20
3.2 Comparison function.....	21
3.3 Calculation function.....	21
3.4 Offline measurement and online measurement.....	22
3.5 Operation example.....	22
3.5.1 Wire operation.....	23
3.5.2 Channel switch operation.....	23
3.5.3 Data comparison operation.....	23
3.5.4 Data calculation operation.....	25
Chapter4 Remote Control.....	26
4.1 RS232 Interface.....	26
4.2 LAN Interface.....	27
Chapter5 Specification.....	28
5.1 Main technical parameters.....	28
5.2 Supplemental characteristics.....	28

Chapter1 Inspection and Installation

1.1 Verifying the Shipment

Unpack the box and check the contents before operating the instrument. If wrong items have been delivered, if items are missing, or if there is a defect with the appearance of the items, contact the dealer from which you purchased the instrument immediately. The package contents include:

Checklist of Package Contents:

Item	Qty.	Model	Remarks
Internal Resistance Tester	x1	IT5102/IT5102E	-
Power Cord	x1	IT-E171/IT-E172/ IT-E173/IT-E174	User may select an appropriate power cord that matches the specifications of power socket used in the area. See the Section Connecting the Power Cord for details.
USB cable	x1	-	This accessory is selected when the USB interface is used for starting up remote operation.
Ex-factory Test Report	x1	-	It is the test report of the instrument before delivery.



NOTE

Upon verification of the shipment, keep the package and relevant contents thereof in a safe place. When returning the instrument for warranty service or repair, the specified packing requirements shall be met.

IT5102 series internal resistance tester is supplied with the following optional accessories (sold separately):

Item	Model	Description
Rack Mount Kit	IT-E151/IT-E151A	This accessory is used to mount the instrument to special rack.
Test Lines	-	-

1.2 Instrument Size Introduction

The instrument should be installed at well-ventilated and rational-sized space. Please select appropriate space for installation based on the internal resistance tester size.

1.3 Dimension

The detail size of the internal resistance tester is shown as below.

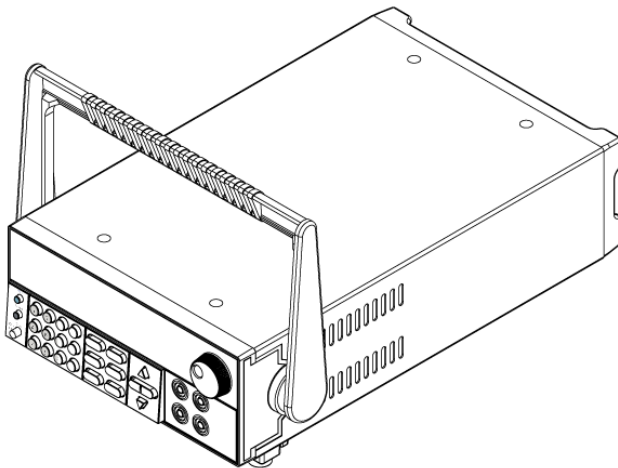

Dimension

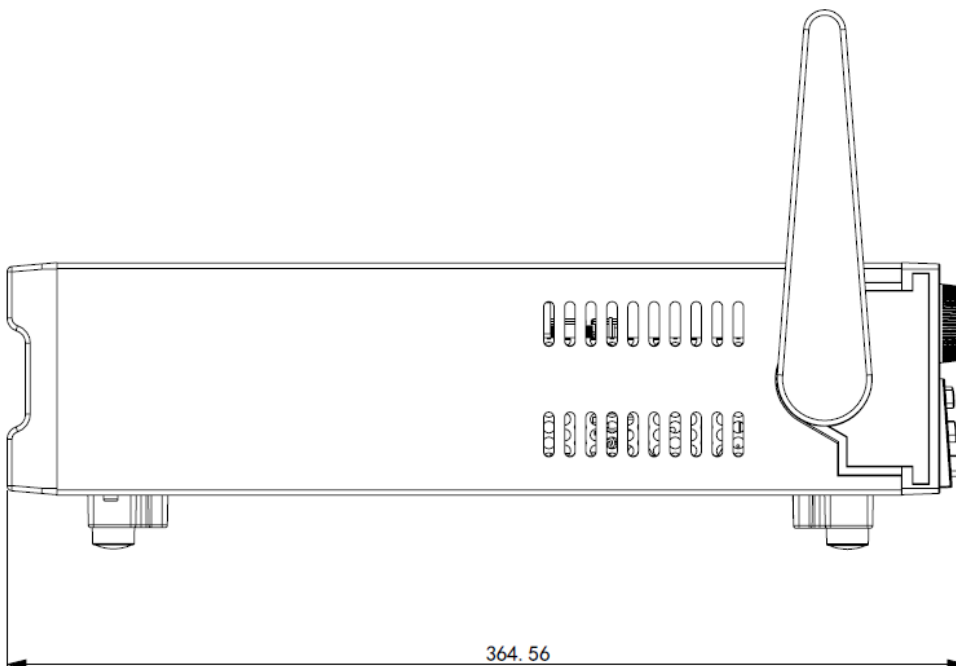
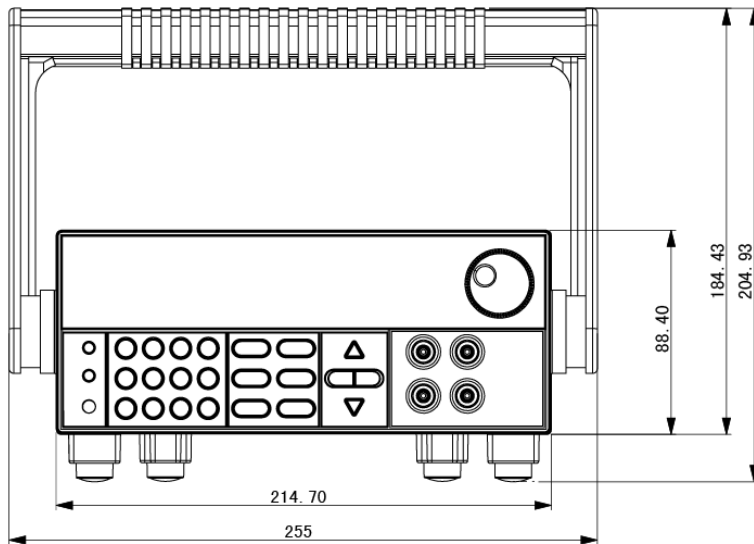

1.4 Adjusting the Handle

The instrument is equipped with a handle for user to easily carry and place it.

The handle can be adjusted in three manners as shown in the figure below. To adjust the handle, first pull out the handle gently toward the left and right sides of the instrument, and then rotate it slowly to its alignment keys.

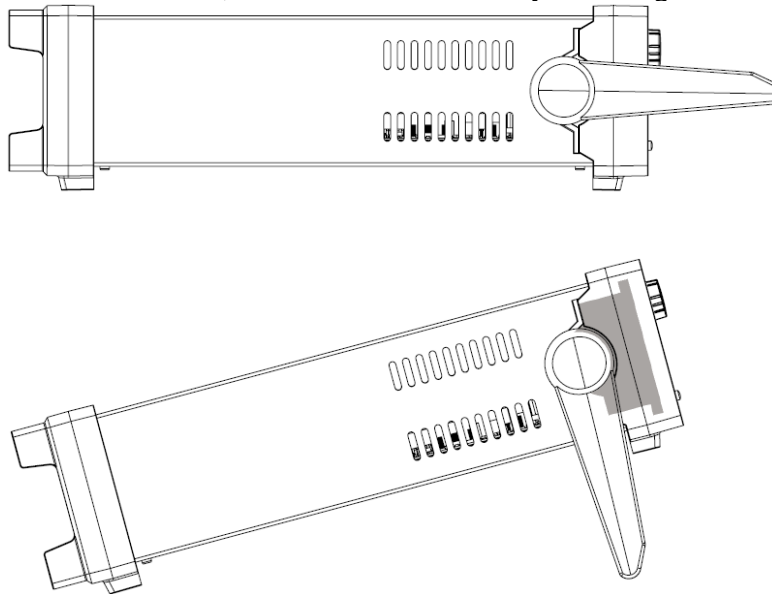

1.5 Removing the Handle

To mount the instrument on a rack, first remove the handle from the instrument.

The handle can be removed following the procedures below:

1. Rotate the handle to the position as shown in the following figure.

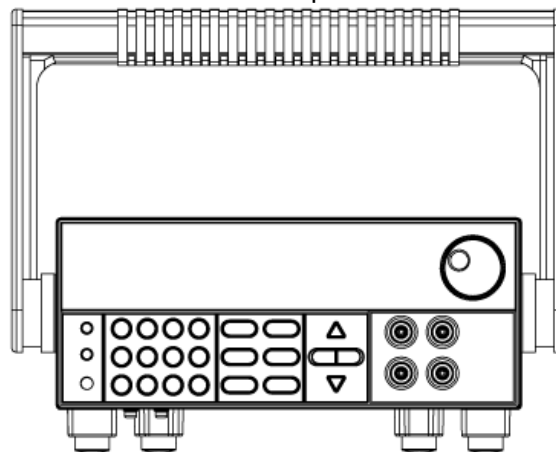

NOTE

The handle can be easily removed from the alignment hole and key between the handle and the instrument.

1. Pull out the handle toward the left and rights sides of the instrument from the alignment hole.



NOTE

When mounting or removing the handle, do not squeeze it too hard and mind your hand.

1.6 Rack Mounting

IT5102 can be mounted on a standard 19" rack. ITECH provides user with IT-E151/IT-E151A rack, as an optional mount kit. The detailed operation please refer to the User Manual of your mount kit.

1.7 Connecting the Power Cord

Before connecting the power cord, please ensure the power switch of the instrument is turned OFF. Only use the power cord supplied as a standard accessory.

A summary of connection procedures is given below.

Select from the following Schedule of Power Cord Specifications an appropriate power cord that matches the voltage for the area in which you use the instrument. If the power cord included in the instrument you purchased does not match the voltage, contact the dealer or manufacturer for change.

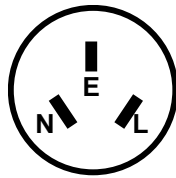

China
IT-E171



United States &
Canada & Japan
IT-E172

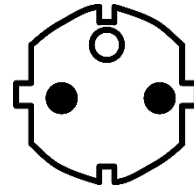

Europe
IT-E173

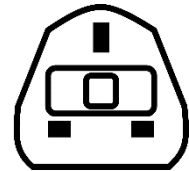

Europe
IT-E174

Chapter2 Quick Start

This chapter introduces power-on check steps of IT5102 to ensure normal start-up and usage under initialization status. This part also introduces the front panel, the rear panel, and key functions of internal resistance tester, make sure that you can quickly know the appearance, instruction and the key function before you operate the instrument. Help you make better use of this series of internal resistance tester.

2.1 Brief Introduction

IT5102 series is a series of battery internal resistance testers with high precision, high resolution and high speed, which can measuring the resistance and voltage of battery simultaneously. IT5102 series can be widely applied in cellphone lithium batteries, electric vehicle batteries and other batteries inspection and sorting.

2.2 Features

IT5102 Series internal resistance tester is featured with:

- Maximum voltage measurement resolution: 0.1mV
- Maximum resistance measurement resolution of: 0.01mΩ
- Resistance and voltage parameters are displayed simultaneously
- Automatically judge whether test results exceed set specifications based on the maximum/minimum limitation of test parameters
- Select measurement frequency 1KHz or 500Hz
- Supports VISA / SCPI protocol
- Built-in LAN, RS232 interfaces
- Supports 8-channels and 16-channels model, and can be set to master and slave to extend the channel.
- Supports measuring the working battery. (can monitoring the battery status under charging or discharging)
- The front panel supports single channel measurement and the back panel supports multiple channels
- Built-in filter function, improve the measurement accuracy
- Supports MX+B function

2.3 Front Panel Introduction

Schematic Diagram of Front Panel of IT5102 series internal resistance tester is as follow.

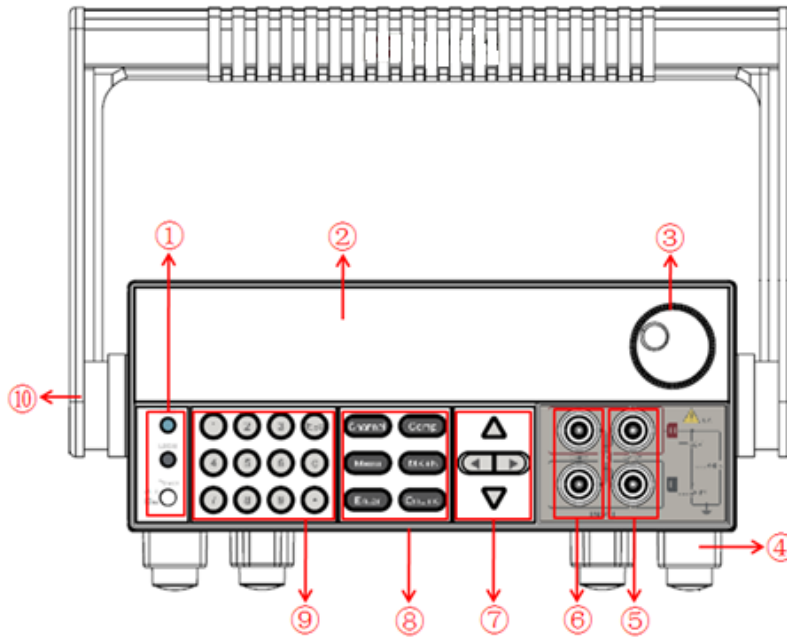

- ① Lock, Local and Power
- ② VFD Display
- ③ Setting knob
- ④ foot
- ⑤ Sense terminals
- ⑥ Source terminals
- ⑦ Arrow keys
- ⑧ Function Keys
- ⑨ Digital keys /Esc key
- ⑩ Handle

IT5102 series internal resistance different models are same the key function in front board, schematic graph as follow.

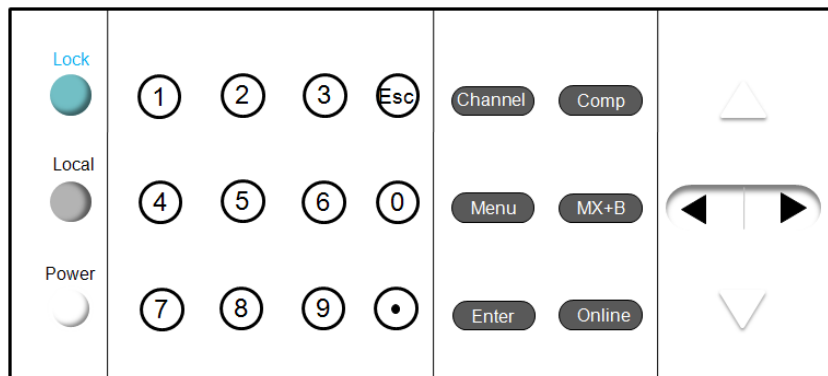

Key tag	Description
(Lock)	Key lock function button, used to lock the front panel buttons
(Local)	switch to the local mode.
(Power)	Power switch
① - ⑨	Numeric key, setting the parameter and switch the channel
Esc	Exit the menu or cancel the setting
Channel	Press this key and the instrument will re-scan the access of the channel. During the scanning process, the instrument will send out the sound of relay switching.

Key tag	Description
Comp	Comparison function. Users can set the comparison range to determine whether the measured voltage or resistance is within this range.
Menu	Menu key, used for setting relevant measurement parameters.
MX+B	Calculate function, is applied for instrument linear amplification of measured data. the value after liner amplification is $M \times B$, where M and B are set values.
Enter	Confirm the setting

2.4 Screen Indicator Lamps Description

IT5102 series internal resistance tester screen indicator lamps description as follows:

Flag	Function description
Rmt	Used for turning on remote control
Addr	When received command successfully, the flag will display 3 seconds.
Error	Error occur
Rear	Analog function begin to work
Auto	Auto range of voltage and resistance.
*	Open the keylock function

2.5 Rear Panel Introduction

Schematic diagram of rear panel of IT5102 series internal resistance tester is as follow.

IT5102 model

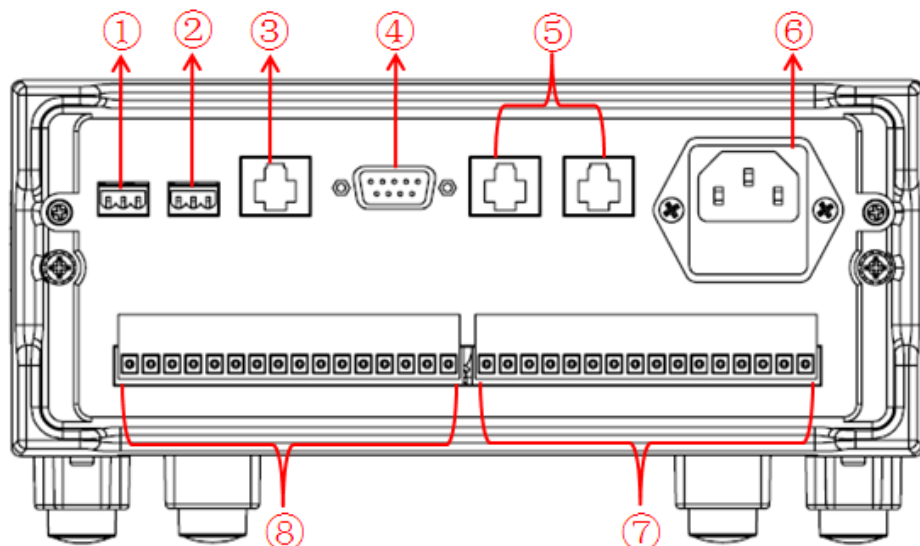

- | | |
|-------------------------------|-----------------------------------|
| ① excitation source (-, M, +) | ⑤ RS485 interface |
| ② Not for user | ⑥ AC input |
| ③ LAN interface | ⑦ Measuring terminals CH9 to CH16 |
| ④ RS232 interface | ⑧ Measuring terminals CH1 to CH8 |

IT5102E model:

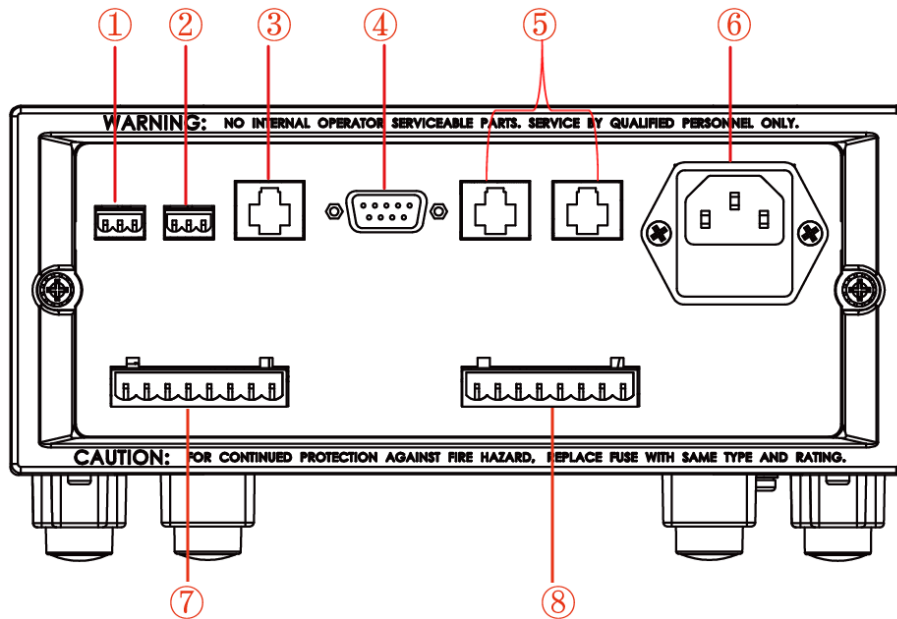

- | | |
|-------------------------------|-----------------------------------|
| ① excitation source (-, M, +) | ⑤ RS485 interface |
| ② Not for user | ⑥ AC input |
| ③ LAN interface | ⑦ Measuring terminals CH9 to CH16 |
| ④ RS232 interface | ⑧ Measuring terminals CH1 to CH8 |

2.6 Power-on Selftest

A successful selftest indicates that the purchased power product meets delivery standards and is available for normal usage.

Before operation, please confirm that you have fully understood the safety instructions.

WARNING

- To avoid burning out, be sure to confirm that power voltage matches with supply voltage.
- Maximum voltage measurement of instrument measurement terminal is 60V, maximum voltage between positive and negative and ground is 480V. Do not connect overvoltage; otherwise, the equipment will be burnt!
- Be sure to connect the main power socket to the power outlet of protective grounding. Do not use terminal board without protective grounding. Before operation, be sure that the internal resistance tester is well grounded.

Selftest steps

The normal power-on process of the IT5102 series internal resistance tester are as follows:

1. Properly connect the power cord and press [**Power**] to power on the instrument.
2. The internal resistance tester will take self-test and the instrument will complete inter-CPU communication test and reading and writing test of memory.
“System Selftest.....”
3. After initialization, the LCD screen displays the following information.

----- Ω -----
----- V -----
Rear

Channel=1

Error Information Reference:

The following error information may occur when an error occurs during Power On self-test:

- If the EEPROM was damaged, the VFD will display:
System selftest...
Eeprom Failure!!!
- If the system setting data in EEPROM is lost, the VFD will display:
System selftest...
System Lost!!!
- If the latest measurement data in EEPROM is lost, then VFD will display:
System selftest...
MeasureLost!!!
- In case of communication between internal microprocessor is failed, then VFD will display:
System selftest...
Communication Failure!!!

Exception handling

If the internal resistance tester cannot start normally, please check as below steps.

1. Check whether the power cord is correctly connected and confirm whether the internal resistance tester is powered.
Correct wiring of power cord = > 2
Incorrect wiring of power cord = > Re-connect the power cord and check whether the exception is removed.
2. Check whether the power in On. Power key is under “**I**” On status.
Yes = > 3
No = > Please check the Power key to start power and check whether the exception is removed.
3. Check whether the fuse of internal resistance tester is burned out.
If yes, change fuse. Detailed steps:
 - i. First pull out the power cord, and then take out the fuse block from the power cord jack with a small screwdriver, as shown below:

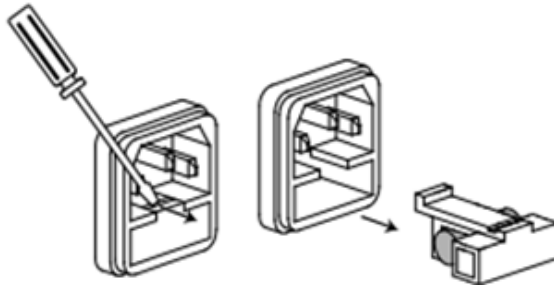

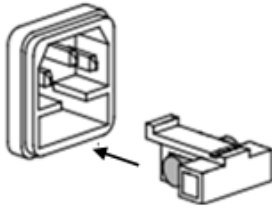

- ii. Have a visual inspection of the fuse to see whether it is burnt out; if yes, replace it with another fuse of the same specification.
- iii. After replacement, mount the fuse block to the original position, as illustrated below:



Chapter3 Function and Features

This chapter describes in detail the use of the front-panel keys and shows how they are used to accomplish internal resistance tester operation.

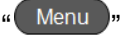
3.1 System Menu

Menu function include system setup and system configuration, Press “  ” on the front panel to enter the sysemt menu interface, press  to select item and press  to set the system menu. You can set the following menu items.

Config	CONFIG MENU		Configuration menu
	Panel	PANEL STATE	Select the measuring terminals.
	Front	Measuring from front panel terminal	
	Rear(default)	Measuring from rear panel terminals	
Mas-Slav	Mas-Slav MODE	Master and slave mode setting	
	Master	Set to master and the address is 0 by default. It can not edit. Set the number of slaves.	
		SLAVE NUMBERS XX	
	Slave	Set to slave and set the address simultaneously	
		LOCAL ADDRESS 00	
Measure	MEASURE RANGE	Select measuring range	
	Auto	Auto range	
	Manual	Setting the range manually. VolRange: Voltage range ResRange: Resistance range	
Freq	FREQUENCY STATE	Frequency selector	
	500Hz		
	1000Hz(default)		
Filter	FILTER STATE	Filter function setting	
	Disable(default)	Disable the filter function	
	Enable	Enable the filter function	





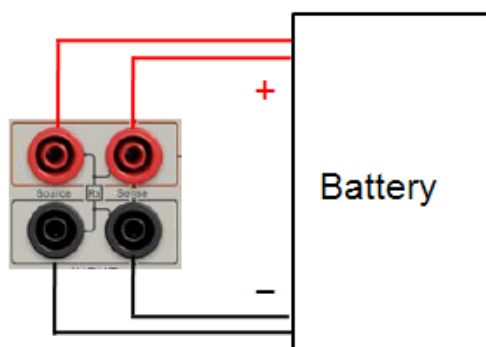

System	SYSTEM MENU	System menu	
	Initialize	INITIALIZE SYSTEM?	Reset all of system configuration
		NO	Do not execute
		YES	Execute initialize
	Buzzer	BUZZER STATE	Setting the buzzer function
		On	Enable the buzzer
		Off	Disable the buzzer
	AlarmSet	ALARM STATE	Alarm setting function
		Disp&Sound	Display the alarm information and beep
		Disp	Only display the alarm information
	Communication	COMMUNICATION	Communication setting
		RS232	RS232
			9600,8,N,1,NONE
		ETHERNET	ETHERNET
			Gateway=192.168.0.1
			IP=192.168.0.211
			Mask=255.255.255.0
			Socket Port=6000
	Info	Instrument information	
		IT51XX Ver:1.00-1.00	Model and version
		SN:XXXXXXXXXXXX XXXXXX	Series Number

3.1.1 Switch measurement between the front and rear panels

For IT5102 Series internal resistance tester, you can switch measurement between the front and rear panels. The rear panel of IT5102E model supports the measurement of 8 channels while the rear panel of the IT5102 model supports the measurement of 16 channels. For both models, the front panel only supports the measurement of 1 channel. When only 1 channel is to be measured, you can select front panel terminal for measurement since the wiring is simple and convenient. The wiring diagram for the front panel terminal measurement is shown as below.



Operation steps

1. Press . The Menu indicator lights up, and VFD displays information below:
 MENU SELECT
 Config System
2. Press . The Panel flashes, and VFD displays information below:
 CONFIG MENU
 Panel Mas/Slav Measure Freq▶
3. Press , and VFD displays information below:
 PANEL STATE
 Front Rear
4. Press . Select Front or Rear, and VFD displays information below:
 PANEL STATE
 Front Rear
 - Front: Front panel terminal measurement
 - Rear: Rear panel terminal measurement
5. Press , and VFD displays information below:
 CONFIG MENU
 Panel Mas/Slav Measure Freq
6. Press  to exit menu settings.

3.1.2 Extension channels for Master and Slave connection

For IT5102 Series internal resistance tester, you can connect several internal resistance testers in cascade through the system bus interface to extend the number of channels and achieve integrated data test.

In all cascading devices, one can be set as the Master and other devices are set as the Slave. The measurement data of the Slave can be displayed on the Master. Press the Numeric key on the Master to switch channels and you can check the measured value of each channel. In Master/Slave mode, the Slave does not receive any commands. All commands must be set on the Master. The Master is set to remote mode.

If ITS5000 test software is used for monitoring, all test data can be saved in the data table for the convenience of checking.

The number of Slaves should be set on the Master. Slaves can be communicated with the Master by setting different communication addresses. The Slave addresses should be set based on the principles below:

Set the number of Slaves to N. If the actual number of Slaves is N, the Slave address is set to 1, 2, ...N respectively.

If the actual number is less than N, the Slave address can be set to any figure within N. However, the address of each Slave should be unique and cannot be repeated.

Schematic Diagram for Master and Slave Connection

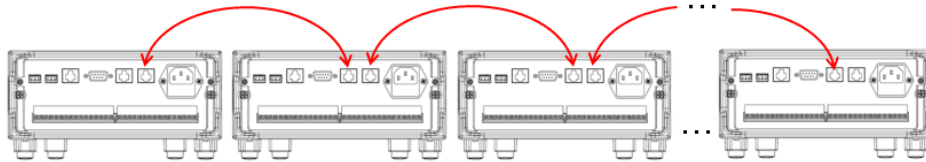

Operation steps for Master and Slave connection







1. Connect each tester to the DUT based on measuring and wiring method.
2. Connect each instrument to the System Bus interface with a cross-over cable based on the Schematic Diagram for Master and Slave connection above.
3. Select one device as the Master. Set Mas/Slav to Master. See “**Operation steps for setting Master**”.
4. Set the first Slave address. See “**Operation steps for setting Slave**”.
5. Continue setting other Slave addresses based on the setting principles of Slave address mentioned above.
6. Press **Channel** on the Master to scan channels.
7. Press the Numeric key to switch channels and check measurement data of corresponding channel.

Operation steps for setting Master

1. Press **Menu**.
MENU SELECT
Config System
2. Press **Enter**.
CONFIG MENU
Panel Mas/Slav Measure Freq▶
3. Press **◀▶** to select Mas/Slav, and press **Enter**.
Mas-Slav MODE
Master Slave
4. Press **◀▶** to select Master, and press **Enter**.
SLAVE NUMBERS
XX
5. Press the Up/Down key to set the number of Slaves, and press **Enter**.
CONFIG MENU
Panel Mas/Slav Measure Freq▶
6. Press **Esc** to exit menu settings.

Operation steps for setting Slave

1. Press **Menu**.
MENU SELECT
Config System
2. Press **Enter**.
CONFIG MENU











- Panel Mas/Slav Measure Freq▷
- Press  to select Mas/Slav, and press  .
Mas-Slav MODE
Master Slave
 - Press  to select Slave, and press  .
LOCAL ADDRESS
05
 - Press the Up/Down key to set the Slave address, and press  .
CONFIG MENU
Panel Mas/Slav Measure Freq▷
 - Press  to exit menu settings.

3.1.3 Range setting

In IT5102 Series internal resistance tester, you can select different ranges for measuring voltage and internal resistance. When the DUT voltage/internal resistance range is known, select an appropriate range and the measurement will be more accurate. The voltage range can be divided into 60V and 6V, and the resistance range can be divided into 2Ω and 200mΩ. When the voltage/internal resistance range is unknown, select Auto.

Operation for selecting measurement range (For example, set the voltage range to 6V.)

Operation steps







- Press  . The Menu indicator lights up, and VFD displays information below:
MENU SELECT
Config System
- Press  . The Panel flashes, and VFD displays information below:
CONFIG MENU
Panel Mas/Slav Measure Freq▷
- Press  to select Measure. Press  , and VFD displays information below:
MEASURE RANGE
Auto Manual
- Press  to select Manual. Press  , and VFD displays information below:
MANUAL RANGE
VolRange ResRange
- Press  to select VolRange, and press  .
VOLTAGE RANGE
60V(default) 6V
- Press  to select 6V, and press  .
MANUAL RANGE
VolRange ResRange
- Press  to exit menu settings.

3.1.4 Measurement frequency setting

IT5102 Series internal resistance tester allows the user to select the measurement frequency to keep the frequency different from the DUT clock frequency, so that the test data is more accurate. In general, the frequency is set to 1000HZ for test. If the test data is inaccurate, set the measurement frequency to 500HZ.

Operation for setting measurement frequency (For example, set frequency to 1000HZ):

Operation steps







1. Press  .
 MENU SELECT
 Config System
2. Press  .
 CONFIG MENU
 Panel Mas/Slav Measure Freq▶
3. Press  to select Freq, and press  .
 FREQUENCY STATE
 500HZ 1000HZ
4. Press  to select 1000HZ, and press  .
 CONFIG MENU
 Panel Mas/Slav Measure Freq▶
5. Press  to exit menu settings.

3.1.5 Filter function setting

This option is to set on/off of the hardware filter. When the environment interface is severe, please turn on the filter function.

Operation for turning on the filter function:







Operation steps

1. Press  .
 MENU SELECT
 Config System
2. Press  .
 CONFIG MENU
 Panel Mas/Slav Measure Freq▶
3. Press  to select Filter, and press  .
 FILTER STATE
 Disable(default) Enable
4. Press  to select Enable, and press  .
 CONFIG MENU
 ◀Filter
5. Press  to exit menu settings.

3.1.6 Initializing menu items

Operation for initializing menu:

Operation steps

1. Press  .
MENU SELECT
Config System
2. Press  to select System, and press  .
SYSTEM MENU
Initialize Buzzer AlarmSet▷
3. Press  .
INITIALIZE SYSTEM?
NO YES
4. Press  to select YES, and press  .
INITIALIZE SYSTEM?
Initialize Done!

SYSTEM MENU
Initialize Buzzer AlarmSet▷
5. Press  to exit menu settings.





The setting for menu initialization is as follows:



Parameter Name	Parameter Value
Panel	Rear
Mas-Slav	Master
Measure	Manual
Freq	1000HZ
Filter	Disable
Buzzer	On
AlarmSet	Disp&Sound
Communication	RS232

3.1.7 Buzzer setting

You can turn on or turn off the buzzer through this menu.

Operation steps









1. Press  .
MENU SELECT
Config System
2. Press  to select System, and press  .
SYSTEM MENU
Initialize Buzzer AlarmSet▷
3. Press  to select Buzzer, and press  .
BUZZER STATE
On(default) Off

4. Press  to select On or Off, and press  .
SYSTEM MENU
Initialize Buzzer AlarmSet▷
5. Press  to exit menu settings.

3.1.8 Alarm setting

This option is to set the alarm method of Comparison function. Disp&Sound means display and sound alarm. When the test data is beyond the range set by the user, VFD displays alarm and gives sound prompt. When Disp is selected, only display Alarm.









Operation steps









1. Press  .
MENU SELECT
Config System
2. Press  to select System, and press  .
SYSTEM MENU
Initialize Buzzer AlarmSet▷
3. Press  to select AlarmSet, and press  .
ALARM STATE
Disp&Sound Disp
4. Press  to select Disp&Sound or Disp, and press  .
SYSTEM MENU
Initialize Buzzer AlarmSet▷
5. Press  to exit menu settings.

3.1.9 Communication setting













IT5102 Series internal resistance tester supports serial port (RS232) and network (ETHERNET) communication. The user can select one to communicate with PC.

Setting steps for RS232 communication

1. Press  .
MENU SELECT
Config System
2. Press  to select System, and press  .
SYSTEM MENU
Initialize Buzzer AlarmSet▷
3. Press  to select Communication, and press  .
COMMUNICATION
RS232 ETHERNET
4. Press  to select RS232, and press  .
RS232
9600,8,N,1 NONE
5. Press  or  to select Communication BPS. In general, select 9600.

- RS232
9600,8,N,1,NONE
6. Press  to locate the cursor to the parity check bit setting, and press  or  to select N
- RS232
9600,8,N,1,NONE
7. Press  to select flow control setting, and press  or  to select NONE.
- RS232
9600,8,N,1,NONE
8. Press .
- SYSTEM MENU
Communication Info
9. Press  to exit menu settings.

Setting steps for ETHERNET communication

1. Press .
- MENU SELECT
Config System
2. Press  to select System, and press .
- SYSTEM MENU
Initialize Buzzer AlarmSet 
3. Press  to select Communication, and press .
- COMMUNICATION
RS232 ETHERNET
4. Press  to select ETHERNET, and press .
- ETHERNET
Gateway=192.168.0.1
5. Press the Numeric key to set gateway address, and press .
- ETHERNET
IP=192.168.0.211
6. Press the Numeric key to set IP address, and press .
- ETHERNET
Mask=255.255.255.0
7. Press the Numeric key to set mask address, and press .
- ETHERNET
Sorket Port=6000
8. Press the Numeric key to set port number, and press .
- SYSTEM MENU
Communication Info
9. Press  to exit menu settings.

RS232 data format

RS-232 data is 10-bit byte with a start bit and a stop bit. The number of start bit and stop bit cannot be edited.

Start Bit	8 Data Bits	Parity=None	Stop Bit
-----------	-------------	-------------	----------

- **Baud rate:** 4800/ 9600/ 19200/ 38400/ 57600/ 115200
- **Data bit:** 8
- **Stop bit:** 1
- **Check:** (none/even/odd)
 EVEN: Even parity check
 ODD: Odd parity check
 NONE: No check
- **Handshake protocol:** (NONE,CTS/RTS,XON/XOFF)
 CTS/RTS: Hardware handshake
 XON/XOFF: Software handshake
 None: None

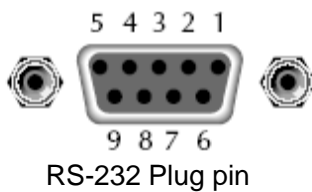









Pin number	Description
1	No connection
2	TXD, transmit data
3	RXD, receive data
4	No connection
5	GND, ground
6	No connection
7	CTS, clear transmission
8	RTS, ready for transmission
9	No connection

3.1.10 Instrument information checking

The user information of instrument includes instrument model, firmware version number and instrument serial number.

Operation steps

1. Press .
 MENU SELECT
 Config System
2. Press  to select System, and press .
 SYSTEM MENU
 Initialize Buzzer AlarmSet 
3. Press  to select Info, and press .
 SYSTEM MENU
 IT5102 Ver:1.00-1.00
4. Press .
 SYSTEM MENU
 SN:602080010696720003

5. Press  to exit menu settings.

3.2 Comparison function

The comparison function of IT5102 Series internal resistance tester is divided into absolute comparison and relative comparison. Absolute comparison allows the user to set the upper and lower limits of voltage and resistance. The instrument can judge whether the voltage or resistance is within the preset range based on measured value. If it is not within the preset range, an alarm signal will be given. The alarm signal is divided into VFD information prompt + sound prompt or VFD information prompt. For details, refer to Alarm Setting chapter.

Relative comparison allows the user to set the relative percentage of voltage and resistance. For example, when 30% is set, if the measured value of a channel is lower than 30% of the average value of all channels, an alarm will be given. The comparison function menu is as follows. For operation, refer to 3.5 Operation Examples.

When IT5102 Series internal resistance tester performs a comparison operation, the voltage and internal resistance should be within the setting range. If any condition is not met, an alarm will be given.

Absolute	Absolute comparison	
	State:Off	
	State:On	
		VolHigh=60.0V
		VolLow=0.0V
		ResHigh=2000.0Ω
		ResLow=0.0Ω
Relative	Relative comparison	
	State:Off	
	State:On	
		Vol=50.0%(V)
		Res=20.0%(mR)

3.3 Calculation function

IT5102 Series internal resistance tester provides calculation function, which can be used for instrument calibration or linear magnification of test data. If the current measured voltage is V , the value after linear magnification through this function is $M(v)*V+B(v)$, where, $M(v)$ and $B(v)$ are set values. Resistance value after linear magnification is $M(r)*R+B(r)$, where, the setting ranges of M and B are:

$M(v)$ and $M(r)$: 0~100; $B(v)$: 0~100V; $B(r)$: 0~100Ω

Operating steps for setting magnification factor and offset are as follows:

Operation steps

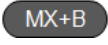
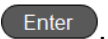
1. Press  .
MXB SETUP
2. Press  .

- MXB(R) SETUP
State: Off
3. Press \triangle to select On, and press **Enter**.
- MXB(R) SETUP
M(r)=1.000 ∇
4. Press the Numeric key to set resistance amplification factor M (r), and press **Enter**.
- MXB(R) SETUP
 \triangle B(r)=0.000 Ω
5. Press the Numeric key to set offset B (r), and press **Enter**.
- MXB SETUP
Mxb(r) Mxb(v)
6. Press **◀▶** to select Mxb(v), and press **Enter**.
- MXB(V) SETUP
State:Off
7. Press \triangle to select On, and press **Enter**.
- MXB(V) SETUP
M(v)=1.000 ∇
8. Press the Numeric key to set voltage amplification factor M (v), and press **Enter**.
- MXB(V) SETUP
 \triangle B(v)=0.000V
9. Press the Numeric key to set offset B (v). Press **Enter**.
- MXB SETUP
Mxb(r) Mxb(v)
10. Press **Esc** to exit.

3.4 Offline measurement and online measurement

In addition to offline measurement of internal resistance, IT5102 Series internal resistance tester also supports online measurement. Online measurement allows the user to measure battery internal resistance when the battery is loaded.

Online measurement operation:

Connect the battery circuit. Connect the battery to be tested to a channel of the internal resistance tester. Press **Online**, and the key indicator lights up. The voltage and internal resistance displayed on VFD are the on-line measured voltage and internal resistance.

3.5 Operation example

The example below allows you to quickly understand the operation related to the internal resistance tester. Take IT5102 model as an example.

Example:

DUT	A battery string composed of 3 batteries, including B1, B2, and B3. The specification voltage for three batteries is 13V.
Measurement instrument	IT5102 internal resistance tester
Channel wiring	Connect Battery 1 to CH1, Battery 2 to CH2, and Battery 3 to CH10.
Data comparison	When the voltage of measured battery is above 12V, it is determined that the battery is fully charged. When the internal resistance of the battery is $30\text{m}\Omega\sim 40\text{m}\Omega$, it is determined that the battery is qualified.
Data calculation	Amplify the voltage to $0.99*V+0.03$ through liner amplification and keep the internal resistance unchanged.

3.5.1 Wire operation

Connect B1, B2, and B3 to the channel interfaces on the rear panel of the internal resistant tester respectively.

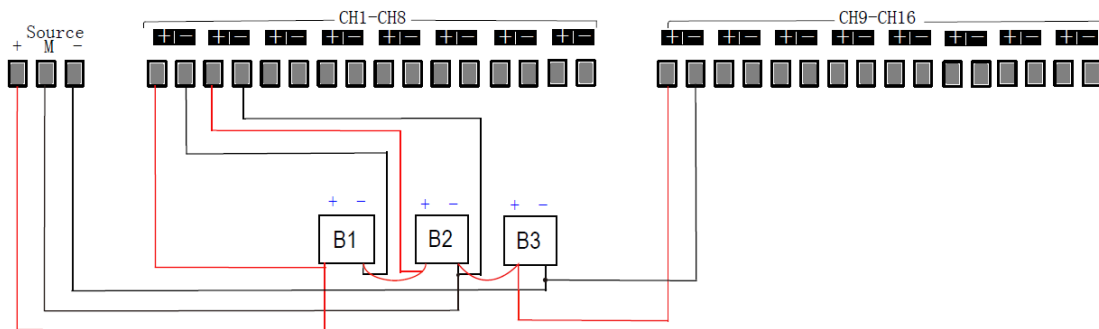

Wiring instructions:

- When Source line is connected, connect the positive and negative poles to the beginning and end of the battery string. Connect M to the negative pole of the battery of the last channel in CH1~CH8.
- During online test, ensure that at least one battery is connected to CH1~CH8 and CH9~CH16.
- When several channels are connected, please distribute channels to CH1~CH8 and CH9~CH16 evenly as much as possible. Ensure that at least one battery is connected to CH1~CH8 and CH9~CH16.

3.5.2 Channel switch operation

Press Power to power on the instrument. If everything is normal, the instrument will detect three channels: For CH1, CH2 and CH10, you can press \triangle or ∇ rotate the knob to switch the channel and check the measurement data.

3.5.3 Data comparison operation

Set data comparison range:

Operation steps

1. Press  .

COMPARE STATE
Absolute Relative(Loop)

2. Press **Enter**.

ABSOLUTE SETUP
State:On

3. Press \triangle to select On, and press **Enter**.

ABSOLUTE SETUP
VoltHigh=60.0V

4. Press Numeric keys 1 and 3 to set voltage upper limit to 13V, and press **Enter**.

ABSOLUTE SETUP
VolLow=0.0V

5. Press Numeric keys 1 and 2 to set voltage lower limit to 12V, and press **Enter**.

ABSOLUTE SETUP
ResHigh=2000.0m Ω

6. Press Numeric keys 4 and 0 to set resistance upper limit to 40m Ω , and press **Enter**.

ABSOLUTE SETUP
VolLow=0.0V

7. Press Numeric keys 3 and 0 to set resistance lower limit to 30 m Ω , and press **Enter**.

COMPARE STATE
Absolute Relative(Loop)

8. Press **Esc** to exit.

After the data comparison range is set, if any existing voltage or resistance value is not within this range, the instrument VFD will give alarm and make an alarm sound.

After the test is completed, turn off the comparison function. The operation is as follows:

1. Press **Comp**.

COMPARE STATE
Absolute Relative(Loop)

2. Press **Enter**.

ABSOLUTE SETUP
State:On

3. Press ∇ to select Off, and press **Enter**.

COMPARE STATE
Absolute Relative(Loop)

4. Press **Esc** to exit.

3.5.4 Data calculation operation

Data calculation operation is as follows:

1. Press **MX+B**.
 MXB SETUP
 Mxb(r) Mxb(v)
2. Press **Enter**.
 MXB(R) SETUP
 State: Off
3. Press **△** to select On, and press **Enter**.
 MXB(R) SETUP
 M(r)=1.000 ▾
4. Press Numeric key 1 to set resistance amplification factor M (r) to 1, and press **Enter**.
 MXB(R) SETUP
 △B(r)=0.000Ω
5. Press Numeric key 0 to set offset B (r) to 0, and press **Enter**.
 MXB SETUP
 Mxb(r) Mxb(v)
6. Press **◀▶** to select Mxb(v), and press **Enter**.
 MXB(V) SETUP
 State:Off
7. Press **△** to select On, and press **Enter**.
 MXB(V) SETUP
 M(v)=1.000 ▾
8. Press the Numeric key to set voltage amplification factor M (v) to 0.99, and press **Enter**.
 MXB(V) SETUP
 △B(v)=0.000V
9. Press the Numeric key to set offset B(v) to 0.03V, and press **Enter**.
 MXB SETUP
 Mxb(r) Mxb(v)
10. Press **Esc** to exit.

If the existing voltage and internal resistance are 0.035mΩ and 12.7V, the test values after linear amplification are 0.035mΩ and 12.603V.

Chapter4 Remote Control

IT5102 series instrument is equipped LAN and RS232 interface. Users can choose the RS232 and LAN to achieve the communication with PC.

4.1 RS232 Interface

There is a COM port (DB9) connector at the rear panel, when connect to computer, you need to connect a cable with COM port on both side;

To active connection, you need to configurate interface settings the same as computer configuration settings. RS-232 interface can be used to program all of the SCPI commands.

RS-232 data format

RS-232 data is 10-bit words contain a start bit and a stop bit. The start bit and stop bit can't be edited. Parity options are stored in nonvolatile memory.

Baud Rate

The system menu allows the user to select a baud rate which is stored in the non-volatile memory: 4800/9600/19200 /38400/57600/115200.

RS232 Connection

Use a RS232 cable with DB-9 interface, RS-232 serial port can connect with the controller (eg PC). Do not use blank Modem cable. Below Table shows the plug pins.

If your computer is using a RS-232 interface with DB-25 connector, you need an adapter cable with a DB-25 connector at one end and the other side is a DB-9(not blank modem cable).



RS232 Pins of Plug

Base pin number	Description
1	No conjunction
2	TXD, data transmission
3	RXD, data receiving
4	No conjunction
5	GND, grounding
6	No conjunction
7	No conjunction
8	No conjunction
9	No conjunction

RS-232 Troubleshooting:

If there is RS-232 connection problem, check the following:

- Computer and instrument must configure the same baud rate, parity, data bits and flow control options. Note that the power configuration as a start bit and a stop bit (these values are fixed).
- As described before in RS-232 connector, you must use the correct interface cable or adapter. Note that even if the cable has the right plug, the internal wiring may be wrong.
- Interface cable must be connected to the correct serial port on the computer (COM1, COM2, etc.).

Communication Settings

Before communication, you should first make the following parameters of instrument and PC matches.

Baud Rate: 9600 (4800/9600/19200/38400/57600/115200). You can enter the system menu from the front panel, and then set the baud rate.

Data bits: 8

Stop Bits: 1

calibration (none, even, odd)

EVEN 8 data bits, have even parity

ODD 8 data bits have odd parity

NONE 8 data bits, no parity

Local Address: (0 ~ 31, the factory default setting is 0)

Parity=None	Start Bit	8 Data Bits	Stop Bit
-------------	-----------	-------------	----------

4.2 LAN Interface

Connect the LAN interface of instrument to the computer with a reticle (crossed). The gateway address should be consistent with that of the PC, and the IP address should be at the same network segment with the PC's IP address.

Chapter5 Specification

This chapter will introduce the rated voltage, current, power and many other main parameters of IT5102 series.

5.1 Main technical parameters

Model		IT5102/IT5102E	
Measurement Range			
Voltage	Range	0~6V	0~60V
	Resolution	0.1 mV	1mV
	Accuracy	$\pm 0.02\% \pm 0.02\% \text{FS}$	
	Temperature Coefficient	$(\pm 0.002\% \pm 0.002\% \text{FS}) / ^\circ\text{C}$	
Resistance	Range	200m Ω	2 Ω
	Resolution	0.01m Ω	0.1m Ω
	Accuracy	$\pm 0.5\% \pm 0.25\% \text{FS}$ Online, $\pm 0.5\% \pm 0.05\% \text{FS}$ Offline; (5%FS above)	
	Temperature Coefficient	$(\pm 0.05\% \pm 0.025\% \text{FS}) / ^\circ\text{C}$ Online, $(\pm 0.05\% \pm 0.005\% \text{FS}) / ^\circ\text{C}$ Offline;	
Specifications			
Input Resistance	>1M Ω		
Channel	16CH(IT5102)/8CH(IT5102E)		
Input Rating	DC60V		
Working temperature	0 $^\circ\text{C}$ ~40 $^\circ\text{C}$ Under 80%RH (non-condensation)		
Storage temperature	-10 $^\circ\text{C}$ ~50 $^\circ\text{C}$ Under 80%RH (non-condensation)		
Open circuit voltage	0.2 Ω about 14V peak		
Fuse specification	AC100V~ AC120V:1.6AT AC220V~ AC240V:1.25AT		
Dimension	340*215*90 (mm)		
Weight(net)	2KG		

The above specifications may be subject to change without prior notice.
When the current in the working circuit which is connected to the battery changes quickly may affect the measurement accuracy!

5.2 Supplemental characteristics

Recommended calibration frequency: once a year

Contact Us

Thanks for purchasing ITECH products. In case of any doubts, please contact us as follows:

1. Visit ITECH website: www.itechate.com
2. Select the most convenient contact method, for further information.