

Programmable AC Power Supply

Series IT7600 User's Manual

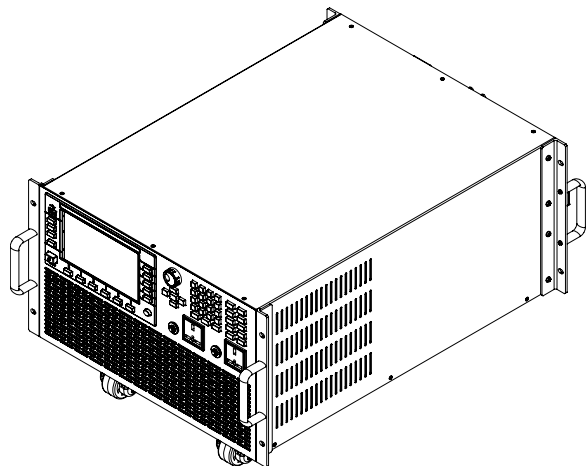

Model: IT7622/IT7624/IT7625/IT7626/IT7627/
IT7628/IT7628L/IT7630/IT7632/IT7634/IT7636
Version: V3.0

Notices

© Itech Electronic, Co., Ltd. 2019
No part of this manual may be reproduced in any form or by any means (including electronic storage and retrieval or translation into a foreign language) without prior permission and written consent from Itech Electronic, Co., Ltd. as governed by international copyright laws.

Manual Part Number

IT7600-402573

Revision

3rd Edition: May. 10, 2019
Itech Electronic, Co., Ltd.

Trademarks

Pentium is U.S. registered trademarks of Intel Corporation.

Microsoft, Visual Studio, Windows and MS Windows are registered trademarks of Microsoft Corporation in the United States and/or other countries and regions.

Warranty

The materials contained in this document are provided “as is”, and is subject to change, without prior notice, in future editions. Further, to the maximum extent permitted by applicable laws, ITECH disclaims all warranties, either express or implied, with regard to this manual and any information contained herein, including but not limited to the implied warranties of merchantability and fitness for a particular purpose. ITECH shall not be held liable for errors or for incidental or indirect damages in connection with the furnishing, use or application of this document or of any information contained herein. Should ITECH and the user enter into a separate written agreement with warranty terms covering the materials in this document that conflict with these terms, the warranty terms in the separate agreement shall prevail.

Technology Licenses

The hardware and/or software described herein are furnished under a license and may be used or copied only in accordance with the terms of such license.

Restricted Rights Legend

Restricted permissions of the U.S. government. Permissions for software and technical data which are authorized to the U.S. Government only include those for custom provision to end users. ITECH provides this customary commercial license in software and technical data pursuant to FAR 12.211 (Technical Data) and 12.212 (Computer Software) and, for the Department of Defense, DFARS 252.227-7015 (Technical Data – Commercial Items) and DFARS 227.7202-3 (Rights in Commercial Computer Software or Computer Software Documentation).

Safety Notices

CAUTION

A CAUTION sign denotes a hazard. It calls attention to an operating procedure or practice that, if not correctly performed or adhered to, could result in damage to the product or loss of important data. Do not proceed beyond a CAUTION sign until the indicated conditions are fully understood and met.

WARNING

A WARNING sign denotes a hazard. It calls attention to an operating procedure or practice that, if not correctly performed or adhered to, could result in personal injury or death. Do not proceed beyond a WARNING sign until the indicated conditions are fully understood and met.



NOTE

A NOTE sign denotes important hint. It calls attention to tips or supplementary information that is essential for users to refer to.

Quality Certification and Assurance

We certify that IT7600 series power supply meets all the published specifications at time of shipment from the factory.

Warranty

ITECH warrants that the product will be free from defects in material and workmanship under normal use for a period of one (1) year from the date of delivery (except those described in the Limitation of Warranty below).

For warranty service or repair, the product must be returned to a service center designated by ITECH.















- The product returned to ITECH for warranty service must be shipped PREPAID. And ITECH will pay for return of the product to customer.
- If the product is returned to ITECH for warranty service from overseas, all the freights, duties and other taxes shall be on the account of customer.

Limitation of Warranty

This Warranty will be rendered invalid if the product is:

- Damaged resulting from customer-wired circuits or customer-supplied parts or accessories;
- Modified or repaired by customer without authorization;
- Damaged resulting from customer-wired circuits or use in an environment not designated by us;
- The product model or serial number is altered, deleted, removed or made illegible by customer;
- Damaged as a result of accidents, including but not limited to lightning, moisture, fire, improper use or negligence.

Safety Symbols

	Direct current		ON (power)
	Alternating current		OFF (power)
	Both direct and alternating current		Power-on state
	Chassis (earth ground) symbol.		Power-off state
	Earth (ground) terminal		Reference terminal
	Caution		Positive terminal
	Warning (refer to this manual for specific Warning or Caution information)		Negative terminal

	A chassis terminal	-	-
---	--------------------	---	---

Safety Precautions

The following safety precautions must be observed during all phases of operation of this instrument. Failure to comply with these precautions or specific warnings elsewhere in this manual will constitute a default under safety standards of design, manufacture and intended use of the instrument. ITECH assumes no liability for the customer's failure to comply with these precautions.

WARNING

- **Do not use the instrument if it is damaged. Before operation, check the casing to see whether it cracks. Do not operate the instrument in the presence of inflammable gasses, vapors or dusts.**
- **The instrument is provided with a power cord during delivery and should be connected to a socket with a protective earth terminal, a junction box or a three-phase distribution box. Before operation, be sure that the instrument is well grounded.**
- **Check all marks on the instrument before connecting the instrument to power supply.**
- **Use electric wires of appropriate load. All loading wires should be capable of bearing maximum short-circuit of electronic load without overheating. If there are multiple loads, each pair of the load power cord must be carry out the full rated short-circuit output current of the power securely.**
- **Ensure the voltage fluctuation of mains supply is less than 10% of the working voltage range in order to reduce risks of fire and electric shock.**
- **Do not install alternative parts on the instrument or perform any unauthorized modification.**
- **Do not use the instrument if the detachable cover is removed or loosen.**
- **To prevent the possibility of accidental injuries, be sure to use the power adapter supplied by the manufacturer only.**
- **We do not accept responsibility for any direct or indirect financial damage or loss of profit that might occur when using the instrument.**
- **This instrument is used for industrial purposes, do not apply this product to IT power supply system.**
- **Never use the instrument with a life-support system or any other equipment subject to safety requirements.**

WARNING

- **SHOCK HAZARD Ground the Instrument.** This product is provided with a protective earth terminal. To minimize shock hazard, the instrument must be connected to the AC mains through a grounded power cable, with the ground wire firmly connected to an electrical ground (safety ground) at the power outlet or distribution box. Any interruption of the protective

(grounding) conductor or disconnection of the protective earth terminal will cause a potential shock hazard that could result in injury or death.

- Before applying power, verify that all safety precautions are taken. All connections must be made with the instrument turned off, and must be performed by qualified personnel who are aware of the hazards involved. Improper actions can cause fatal injury as well as equipment damage.
- **SHOCK HAZARD, LETHAL VOLTAGES** This product can input the dangerous voltage that can cause personal injury, and the operator must always be protected from electric shock. Ensure that the input electrodes are either insulated or covered using the safety covers provided, so that no accidental contact with lethal voltages can occur.
- Never touch cables or connections immediately after turning off the instrument. Verify that there is no dangerous voltage on the electrodes or sense terminals before touching them.

CAUTION

- **Failure to use the instrument as directed by the manufacturer may render its protective features void.**
- **Always clean the casing with a dry cloth. Do not clean the internals.**
- **Make sure the vent hole is always unblocked.**

Environmental Conditions

The instrument is designed for indoor use and an area with low condensation. The table below shows the general environmental requirements for the instrument.



Environmental Conditions	Requirements
Operating temperature	0°C~40°C
Operating humidity	20%~80%(non-condensation)
Storage temperature	-10°C~70 °C
Altitude	Operating up to 2,000 meters
Installation category	II
Pollution degree	Pollution degree 2



Note

To make accurate measurements, allow the instrument to warm up for 30 min.

Regulatory Markings

	The CE mark indicates that the product complies with all the relevant European legal directives. The specific year (if any) affixed refers to the year when the design was approved.
	The instrument complies with the WEEE Directive (2002/96/EC) marking requirement. This affix product label indicates that you must not discard the electrical/electronic product in domestic household waste.

	<p>This symbol indicates the time period during which no hazardous or toxic substances are expected to leak or deteriorate during normal use. The expected useful life of the product is 10 years. The product can be used safely during the 10-year Environment Friendly Use Period (EFUP). Upon expiration of the EFUP, the product must be immediately recycled.</p>
---	--

Waste Electrical and Electronic Equipment (WEEE) Directive



2002/96/EC Waste Electrical and Electronic Equipment (WEEE) Directive

This product complies with the WEEE Directive (2002/96/EC) marking requirement. This affix product label indicates that you must not discard the electrical/electronic product in domestic household waste.

Product Category

With reference to the equipment classifications described in the Annex 1 of the WEEE Directive, this instrument is classified as a “Monitoring and Control Instrument”.

To return this unwanted instrument, contact your nearest ITECH office.

Compliance Information

Complies with the essential requirements of the following applicable European Directives, and carries the CE marking accordingly:

- Electromagnetic Compatibility (EMC) Directive 2014/30/EU
- Low-Voltage Directive (Safety) 2014/35/EU

Conforms with the following product standards:

EMC Standard

IEC 61326-1:2012/ EN 61326-1:2013 ¹²³

Reference Standards

CISPR 11:2009+A1:2010/ EN 55011:2009+A1:2010 (Group 1, Class A)

IEC 61000-4-2:2008/ EN 61000-4-2:2009

IEC 61000-4-3:2006+A1:2007+A2:2010/ EN 61000-4-3:2006+A1:2008+A2:2010

IEC 61000-4-4:2004+A1:2010/ EN 61000-4-4:2004+A1:2010

IEC 61000-4-5:2005/ EN 61000-4-5:2006

IEC 61000-4-6:2008/ EN 61000-4-6:2009

IEC 61000-4-11:2004/ EN 61000-4-11:2004

1. The product is intended for use in non-residential/non-domestic environments. Use of the product in residential/domestic environments may cause electromagnetic interference.
2. Connection of the instrument to a test object may produce radiations beyond the specified limit.
3. Use high-performance shielded interface cable to ensure conformity with the EMC standards listed above.

Safety Standard

IEC 61010-1:2010/ EN 61010-1:2010

Content

Quality Certification and Assurance	i
Warranty	i
Limitation of Warranty.....	i
Safety Symbols.....	i
Safety Precautions	ii
Environmental Conditions.....	iii
Regulatory Markings.....	iii
Waste Electrical and Electronic Equipment (WEEE) Directive.....	iv
Compliance Information.....	v
Chapter1 Acceptance and Installation	1
1.1 Confirm package contents.....	1
1.2 Instrument Size Introduction.....	1
1.3 Connecting the cabinet.....	7
1.4 Connecting the Power Cord	7
1.5 Connecting Test Lines (Optional)	10
Chapter2 Quick Start.....	13
2.1 Brief Introduction	13
2.2 Front Panel Introduction	14
2.3 Key introduction	15
2.4 Introduction to Information on the Interface.....	17
2.5 Introduction to Interface Symbols	18
2.6 Rear Panel Introduction	18
2.7 Power-on Selftest	22
Chapter3 Basic Operations	26
3.1 Output On/Off Operation	26
3.2 AC Output Mode	26
3.3 DC Output Mode.....	27
3.4 ACDC Output Mode.....	27
3.5 Switching Output range	28
3.6 Waveform Selection.....	28
3.7 Sweep function	28
3.8 Key Lock Function	29
3.9 Switching Local/Remote Mode.....	30
3.10 Menu Operation.....	30
3.11 Transformer Function.....	34
3.12 Configuration Save/Recall Function	34
3.13 Protection Function.....	34
3.14 Data Recording Function.....	36
3.15 Screen Capture Function.....	36
3.16 Trigger Function.....	36
3.17 External Simulation Test Function	37
3.18 Remote Measurement Function	39
3.19 Parallel Function.....	40
3.20 Three-phase Parallel Function	41
3.21 Three-phase mode setup	46
Chapter4 Measurement Functions	48
4.1 Interface Introduction.....	48
4.2 Setup interface	48
Chapter5 Oscilloscope Functions	50
5.1 Interface Introduction.....	50
5.2 Adjustment of measuring parameters.....	53
5.3 Setting of Trigger Configuration.....	54
Chapter6 Harmonic Function.....	55
6.1 Interface Introduction.....	55

6.2 Distortion factor calculation formula	57
Chapter7 Vector Function	59
Chapter8 Configuration of Any Waveform.....	61
8.1 List Function	61
8.2 Setting of Surge/trapped Configuration	70
8.3 Self-defined Waveform Function	72
8.4 THD Wave	74
Chapter9 Technical Specifications	77
9.1 Main technical parameters	77
9.2 Supplemental characteristics.....	101
Chapter10 Remote Control.....	102
10.1 RS232 Interface.....	102
10.2 USB Interface	103
10.3 LAN Interface.....	104
10.4 GPIB Interface	104
10.5 CAN Communication Port	104
Appendix	106
Specifications of Red and Black Test Lines.....	106

Chapter1 Acceptance and Installation

1.1 Confirm package contents

Open the package and check the articles within package box before operation. In case of any non-conformity, missing or appearance wearing, please contact ITECH immediately.

The package box should comprise:

Device name	Quantity	Model	Remarks
Programmable AC Power Supply	x1	IT7600 series	IT7600 series include: IT7622/IT7624/IT7625/IT7626/IT7627 /IT7628/IT7628L/IT7630/IT7632 /IT7634/IT7636
Power Cord	xN	-	Number of the power cords vary depending on the model, See the Section 1.4 Connecting the Power Cord for power cord connection.
USB cable	x1	-	-
Factory alignment report	x1	-	Test report before delivery



NOTE

After confirming that package contents are consistent and correct, please appropriately keep package box and related contents. The package requirements should be met when the instrument is returned to factory for repair.

1.2 Instrument Size Introduction

The instrument should be installed at well-ventilated and rational-sized space. Please select appropriate space for installation based on the power supply size.

IT7622/IT7624

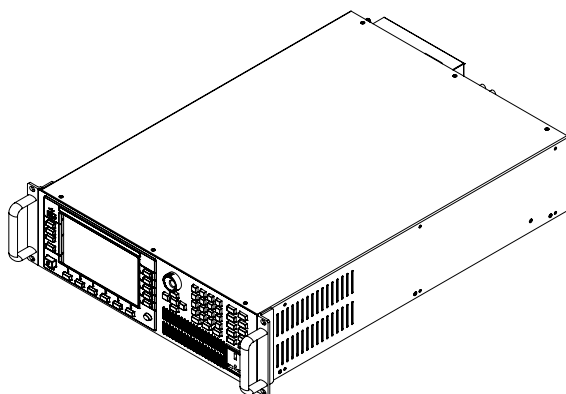

Detailed Dimension Drawing

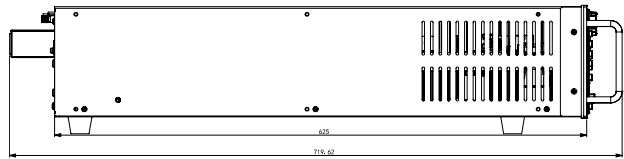
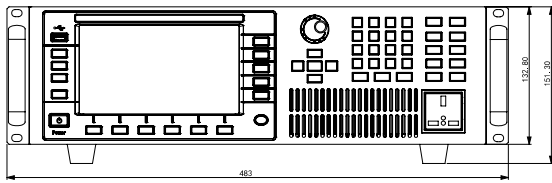

IT7625

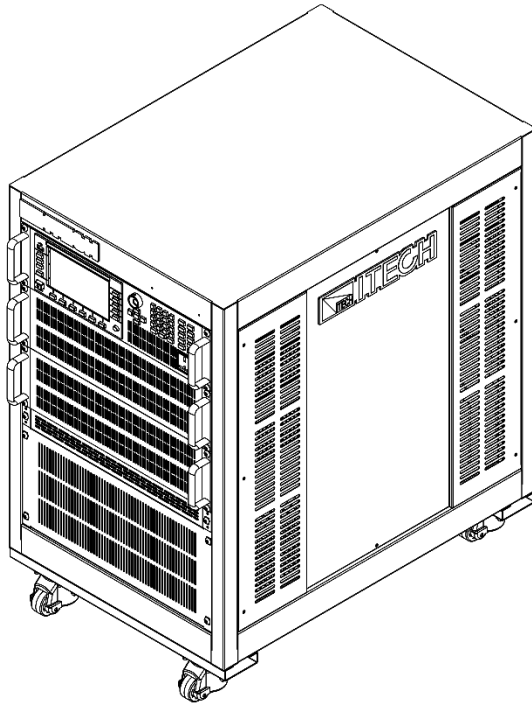

Detailed Dimension Drawing

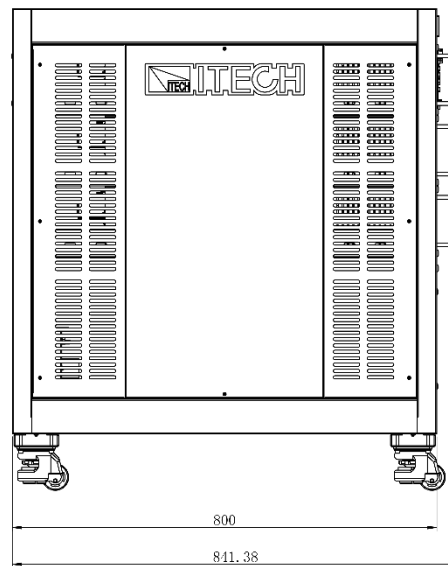
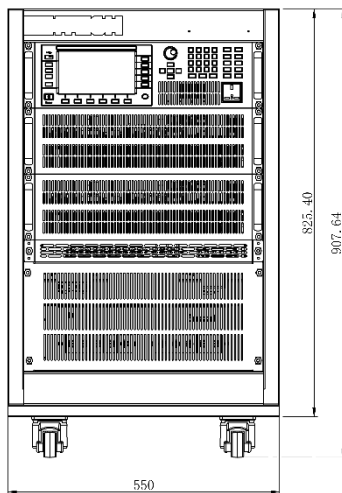

IT7626

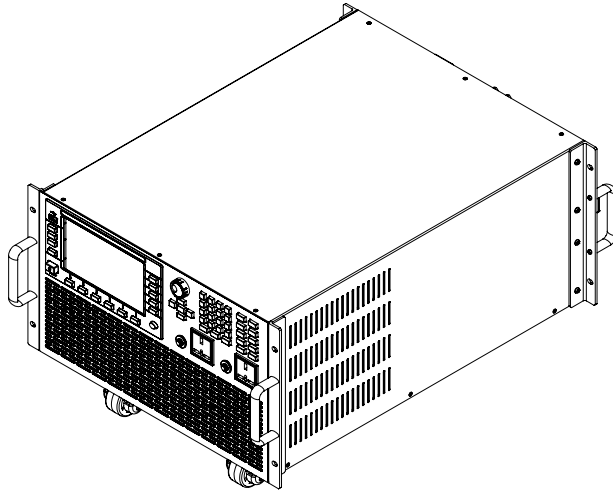

Detailed Dimension Drawing

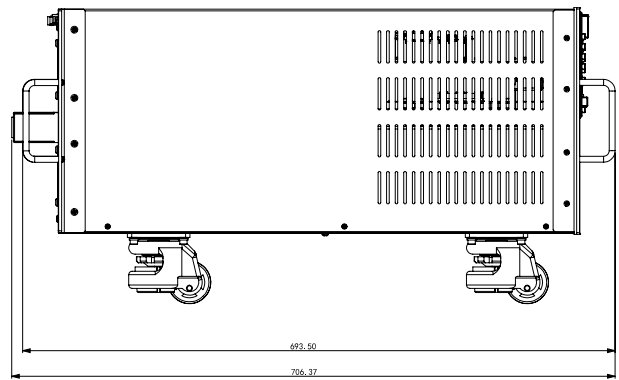
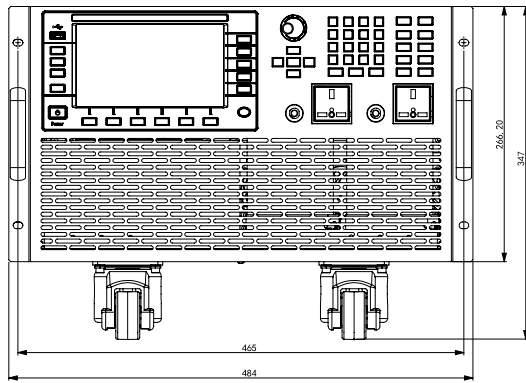

IT7627

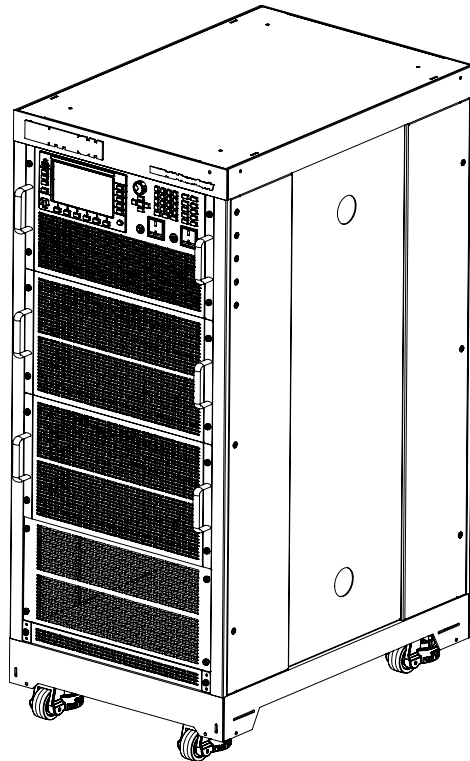

Detailed Dimension Drawing

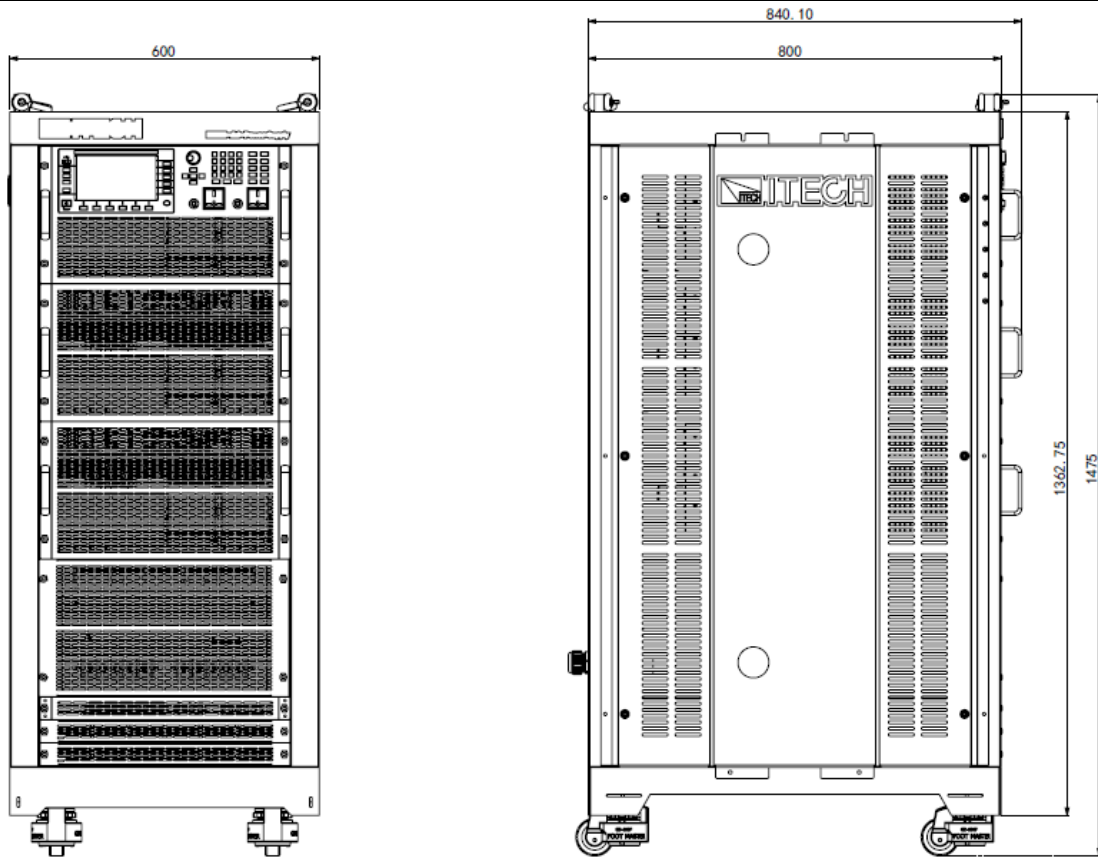

IT7628/IT7628L

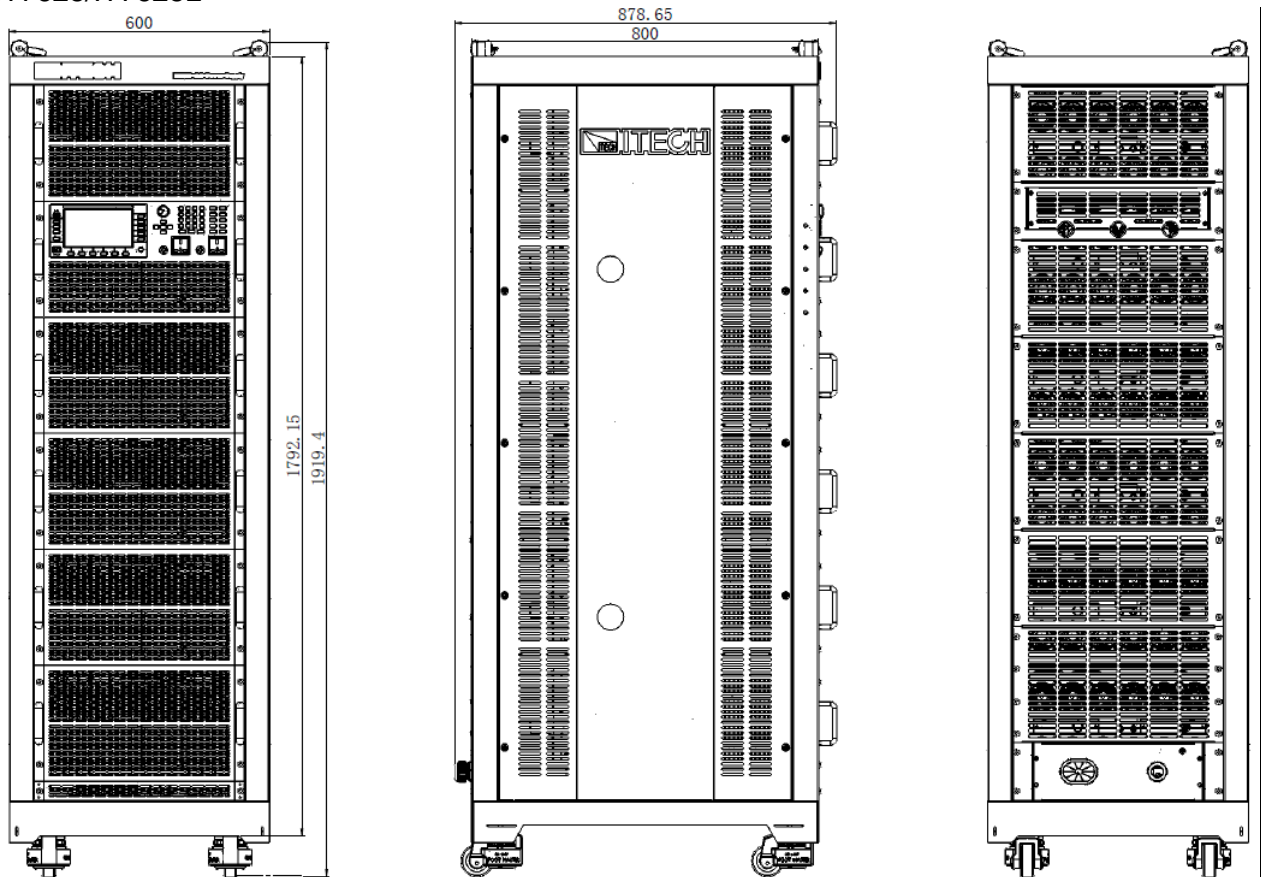

IT7630/IT7632

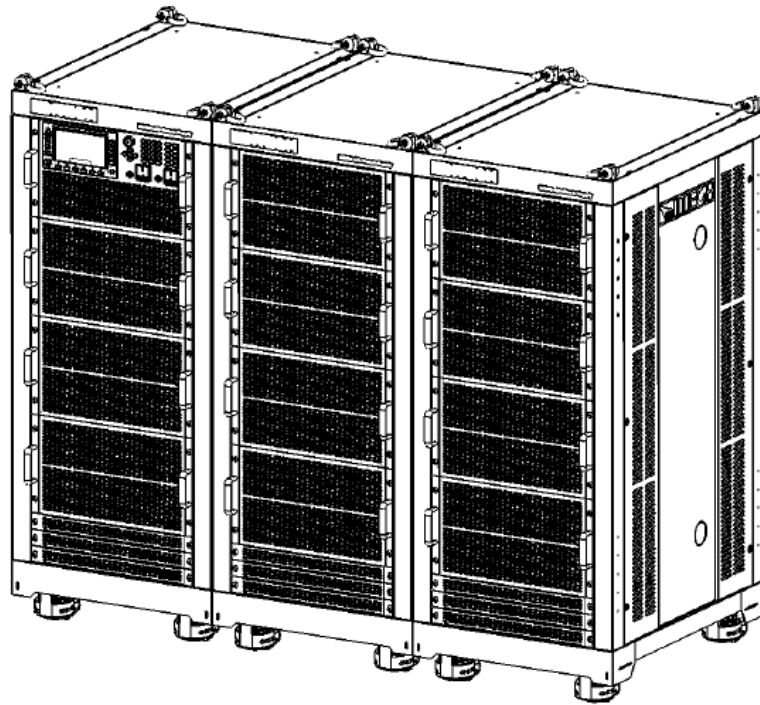

Detailed Dimension Drawing

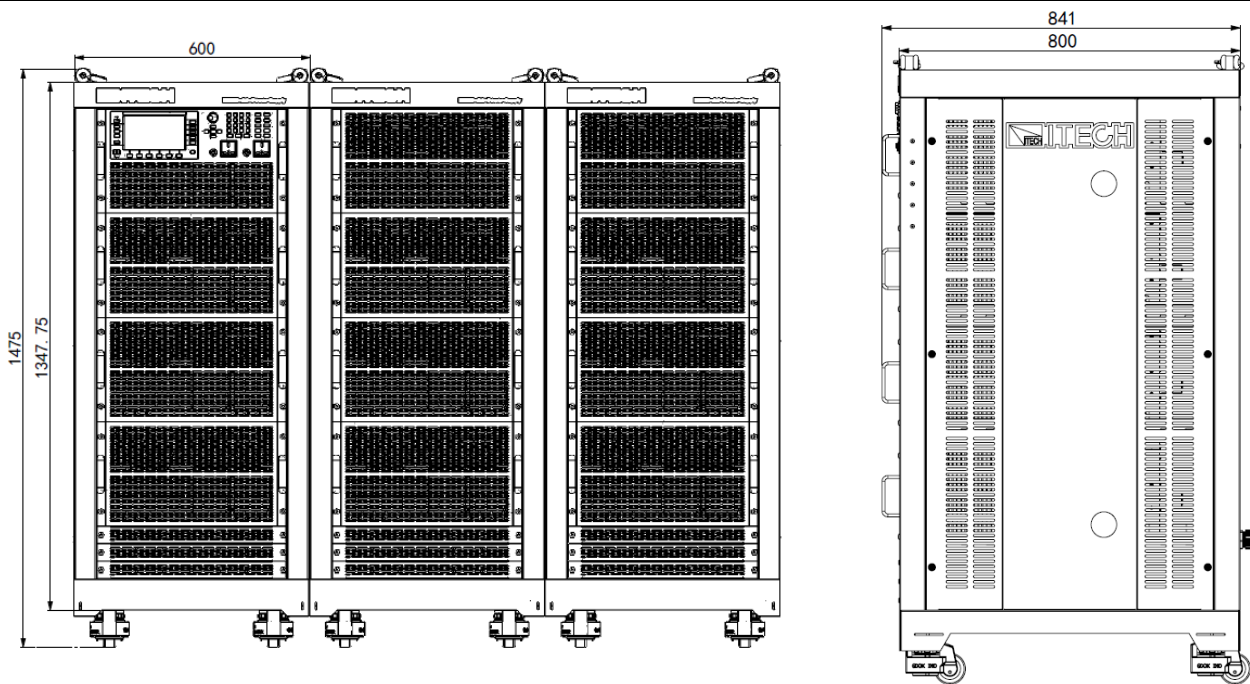

IT7634/IT7636

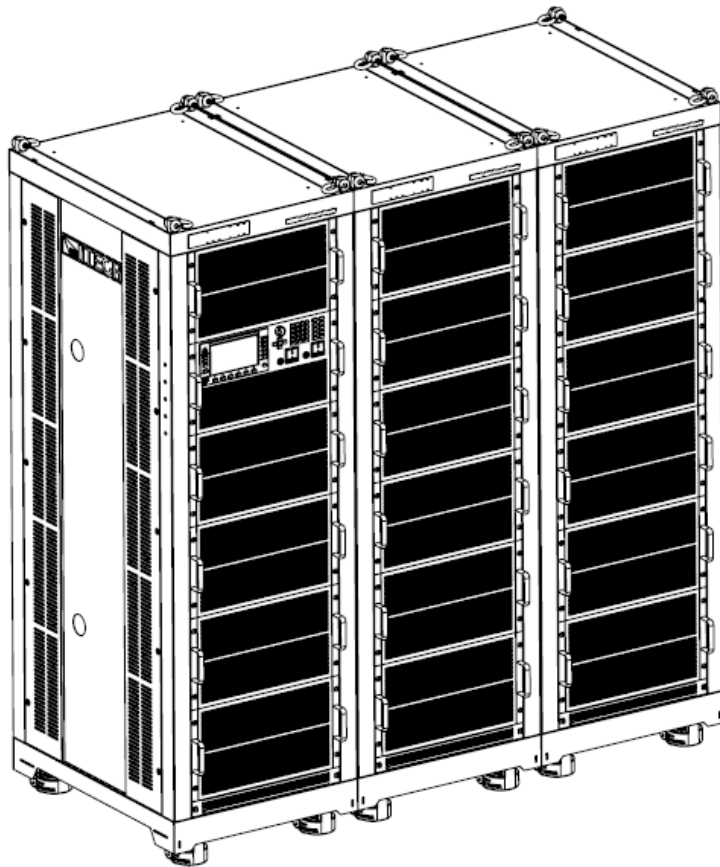

Detailed Dimension Drawing

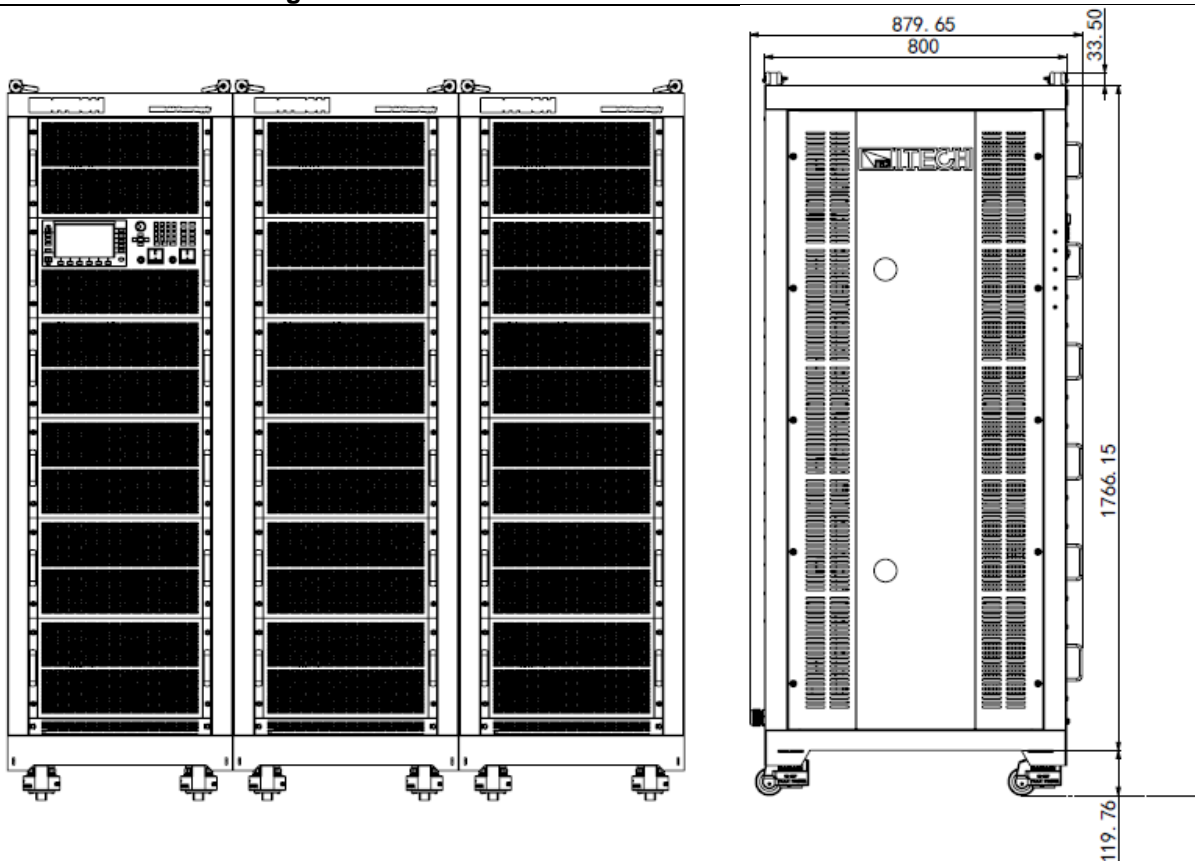

1.3 Connecting the cabinet

IT7630 series (IT7630/IT7632/IT7634/IT7636) power supply consists of three cabinets. The cabinet with front panel is the system master and others are slaves.

The user needs to connect system bus, power output terminals and remote measurement terminals among three cabinets. Before connecting, the user needs to take apart the rear panel which covers the terminals by using a screwdriver. Take example of IT7630. The wiring diagram is shown as follows. Please refer to 2.6 Rear Panel Introduction for the detailed rear panel introduction.

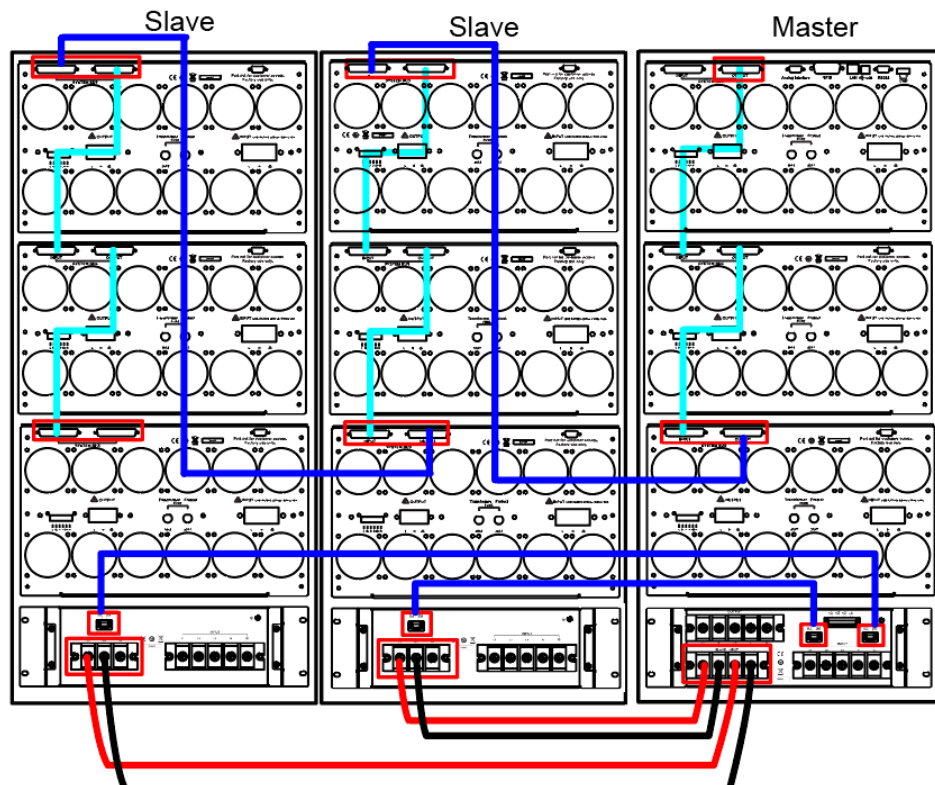

1.4 Connecting the Power Cord

Connect power cord of standard accessories and ensure that the power supply is under normal power supply.

AC power input level

- Working voltage for IT7622/IT7624 is 110V or 220V. Select a proper line voltage according to the voltage of your facility. You can use the line selector switch on the bottom of the instrument to select the right voltage.
- Working voltage for IT7626 is 220V.
- Working voltage for IT7625/IT7627/IT7628/IT7628L/IT7630/IT7632/IT7634/IT7636 is 380V.

Pay attention to the working input voltage.

Before connecting the power cord

To prevent electric shock and damage to the instrument, observe the following precautions.

WARNING

- Before connecting the power cord, please confirm the 110V / 220V transfer switch to ensure that the switch matches the supply voltage. Otherwise, the instrument may be damaged.
- Before connecting power cord, be sure to switch off the instrument. Power switch is in Off position.
- To avoid fire or electric shock, Make sure to use the power cord supplied by ITECH.
- Be sure to connect the main power socket to the power outlet with protective grounding. Do not use terminal board without protective grounding
- The instrument rear panel provides a separate screw used for chassis ground. Please make proper connections. In the event of a failure, not using a properly grounded protective earth and grounded outlet may result in personal injury or death due to electric shock.
- Ensure that the power cord connection is either insulated or covered using the safety covers provided, so that no accidental contact with lethal voltages can occur.
- The power cords supplied with this product is certified for safety. In case the supplied lines assembly needs to be replaced, or an extension lines must be added, be sure that it can meet the required power ratings of this product. Any misuse voids the warranty of this product.

Connecting the power cord

- The AC input connection of IT7622/IT7624 is the same as that of IT7626. The power cord is shown in the next figure.

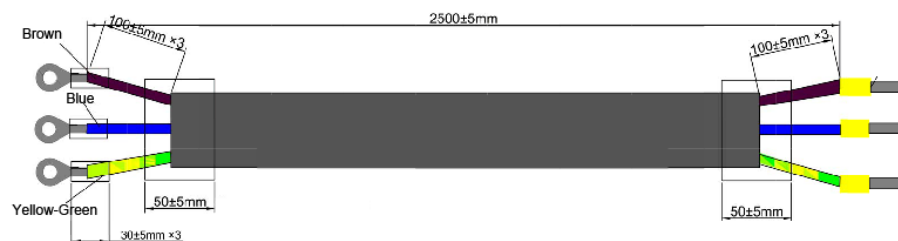

Connecting Method:

1. See the below illustration, connect one end of the AC power cord to the AC input terminals in the rear panel of the power supply. Connect the fire wire, zero line and ground to the corresponding terminal of the device. Before inserting, please loosen the screw. Lock the screw when it is inserted.
2. Connect the three terminals brown to line (L), blue to neutral (N), and yellow-green to ground (PE) on the other end of the power cord to your AC distribution panel.

AC input terminals of rear panel

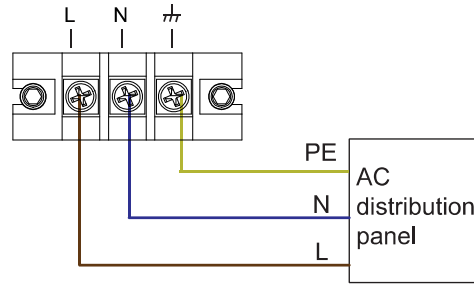

- One end of the AC power cord for IT7625/IT7627/IT7628/IT7628L/IT7630/IT7632/IT7634/IT7636 is connected to the AC input terminals on the rear panel of the power supply. The user needs to connect the other end of the AC power cord to the AC distribution panel. The detailed description is shown as follows.

- ◆ The power cord of IT7625/IT7627/IT7630 is shown in the next figure.

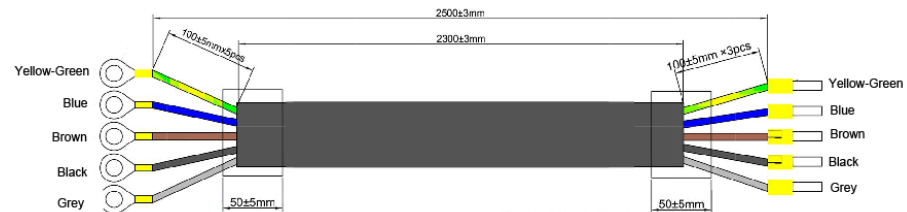

- ◆ The power cord of IT7628/IT7628L/IT7632/IT7634/IT7636 is shown in the next figure.

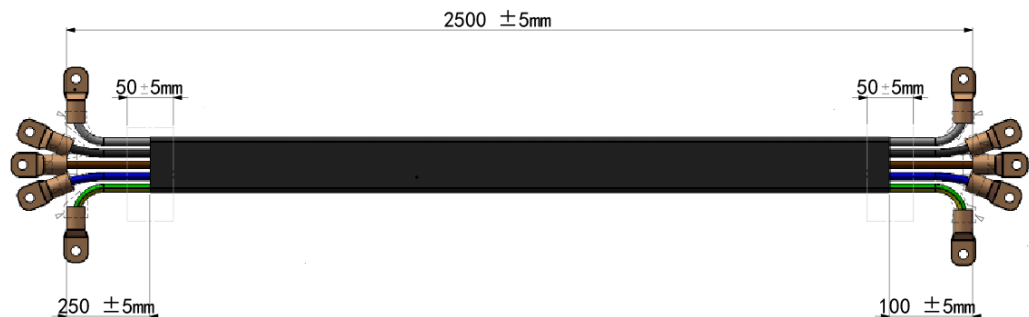

Connect the five terminals brown to line (L1), gray to line (L2), black to line (L3), blue to neutral (N), and yellow-green to ground (PE) on the other end of the power cord to your AC distribution panel.

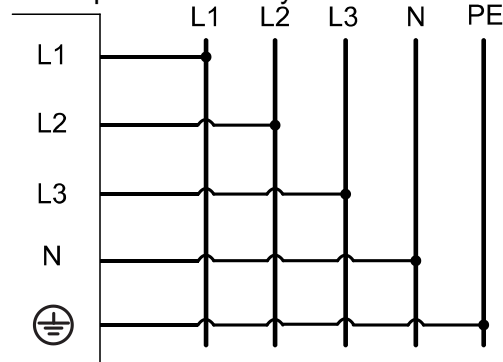

1.5 Connecting Test Lines (Optional)

Test lines are not standard accessories of the instrument. Please select optional red and black test lines for individual sales based on the maximum current value. For specifications of test lines and maximum current values, refer to “**Specifications of Red and Black Test Lines**” in “**Appendix**”.

WARNING

- Before connecting test lines, be sure to switch off the instrument. Power switch is in Off position. Otherwise, contact with output terminals in rear panel may cause electrical shock.
- To avoid electrical shock, before testing, please make sure the rating values of the testing lines, and do not measure the current that higher than the rating value. All test lines shall be capable of withstanding the maximum short circuit output current of the power supply without causing overheat.
- If several loads are provided, each pair of load wires shall safely withstand the rated short circuit output current of the power supply under full load.
- To avoid battery short circuit, be sure to check that the test line end is not connected when connecting or disassembling the test line. When the test line end is connected with battery, short circuit may cause severe accident.
- Always use test lines provided by ITECH to connect the equipment. If test lines from other factories are used, please check that the test line can withstand maximum current.

The front panel of IT7600 series power supply is equipped with the front panel output terminal and rear panel output terminal (see the introduction to the front panel and rear panel for the locations of AC output terminals). Test line connection is given below taking local measurement as example. Before connecting the test lines, be sure that the instrument Power is in Off position. Check whether the shorting clip of Sense terminal is correctly mounted.

Connection of the front panel output terminal

The maximum output current of the front panel output terminal is 10A. In order to facilitate operation, the user can directly connect the front panel output terminal if the output current is less than 10A.

- Don't use the front panel output terminal of IT7622/IT7624/IT7625/IT7628L to output current which exceeds 10A. If you do, you may damage the instrument.
- If the output current of the front panel output terminal of IT7626/IT7627/IT7628/IT7630/IT7632/IT7634/IT7636 power supply exceeds 10A, the overcurrent protection terminal of the front panel will automatically bounce up to protect the front AC output terminal. If the current of the connected load is less than 10A, directly push the fuse box in.

Connection of the rear panel output terminal

The user can connect the rear panel output terminal according to the power output specifications. Specific connection of IT7622/IT7624/IT7626 is shown in the figure below.

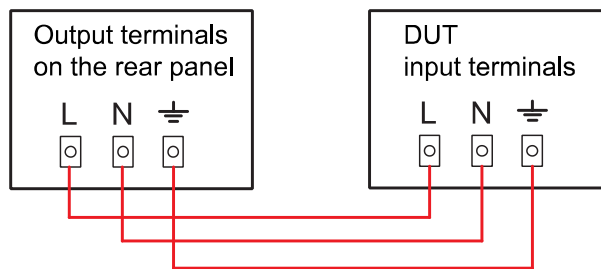

NOTE

When the output voltage has DC voltage, the output terminal L is Hi, and N is Lo.

The output terminal on the rear panel of IT7625/IT7627/IT7628/IT7628L/IT7630/IT7632/IT7634/IT7636 is similar. IT7625/IT7627/IT7628/IT7628L can be used not only as a single-phase power source, but also as a three-phase power source. IT7630/IT7632/IT7634/IT7636 only can be used as a three-phase power source.

Specific connection is shown in the next figure. (Take the example of IT7625.)

- When used as a single-phase power source, the connection is shown in the next figure.

WARNING

When IT7625/IT7627/IT7628/IT7628L is used as a single-phase power source, please connect the output terminals: L1, N, GND.

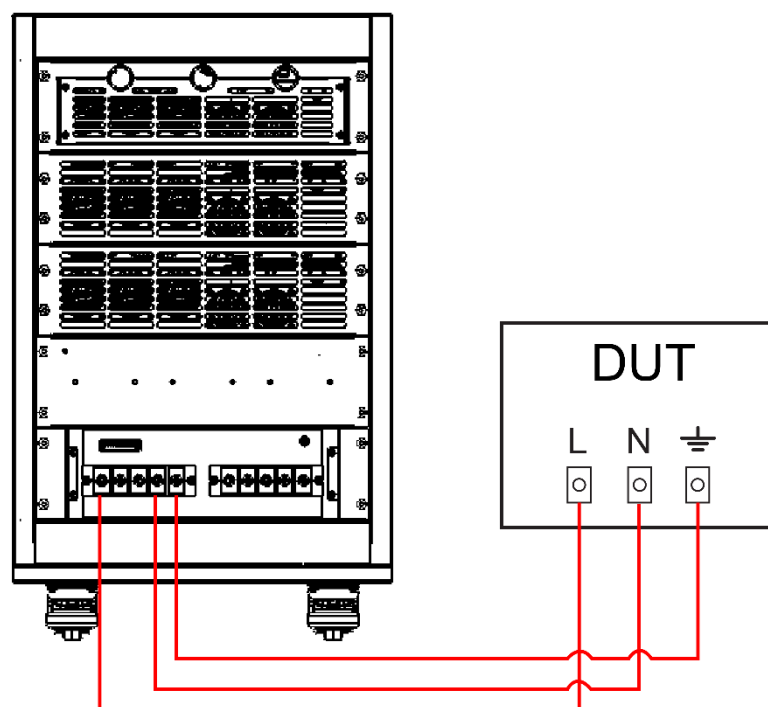

- When used as a three-phase power source, the connection is shown in the next figure.

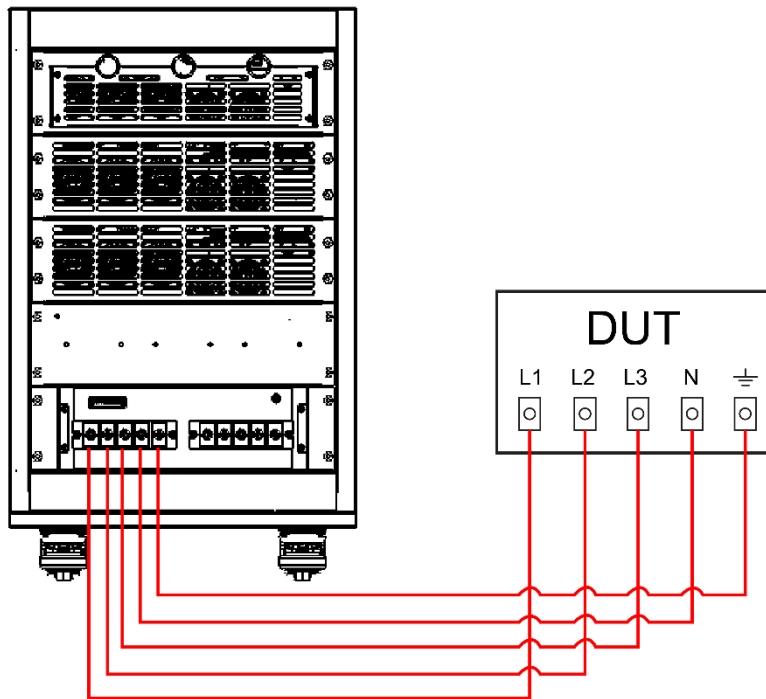

Operation steps

1. (Optional) Unscrew and remove the protection cover.
2. Unscrew the screws of the output terminals and connect the red and black test lines to the output terminals. Re-tighten the screws.

When maximum current that one test line can withstand fails to meet the current rated current, use several pieces of red and black test lines. For example, the maximum current is 1,200A, then 4 pieces of 360A red and black lines are required.

3. (Optional) Install the protection cover, leave the other end of the red and black lines outside.
4. Directly connect the other end of the red and black lines to the DUT terminal.

Chapter2 Quick Start

This chapter introduces the front panel, the rear panel, key functions and LCD display function of the IT7600 series power supply, make sure that you can quickly know the appearance, instruction and the key function before you operate the power supply. Help you make better use of this series of power supply.

2.1 Brief Introduction

IT7600 series high performance programmable AC power supplies, adopt advanced digital signal processing technology, with frequency up to 10-5000 Hz, built-in all-round power meter and large-screen oscilloscope function. Power up to 54 kVA and support master-slave parallel, which can provide high-capacity single-phase or three-phase AC output. IT7600 has built-in arbitrary waveform generator to simulate the harmonic and a variety of arbitrary waveforms output; also has strong exchange measurement and analysis functions. IT7600 can be widely used in many areas, such as new energy, home appliances, power electronics, avionics, military, the development and application of IEC Standard test and so on.

Main features and advantages are listed below:

- Realize AC, DC, AC+DC output modes, AC+DC can realize simulating distortion of DC Voltage
- The output waveform start / stop phase angle can be set
- Simulate the output of any waveform
- Built-in various waveform database
- External 0-10V analog control
- Voltage/current analog monitoring
- OTP, OCP (Including peak and rms values), OVP, OPP
- Smart temperature-control fan with low noise
- The power supply is able to measure Vrms, Vpk, Vdc, Irms, Ipk, W, VA, VAR, CF, PF and THD, and has the function of harmonic analysis
- Display the real-time curve. If multiple units are connected in parallel, the status information of all modules will be displayed simultaneously
- Support single/three-phase output, and can simulate unbalanced three phase output
- List mode can simulate civil use AC network, achieve simulation of instantaneous power interruption
- Standard communication interface RS232 GPIB LAN USB CAN
- USB on the front panel can achieve importing and exporting file functions and data storage function

Model	Voltage(V)	Current(A)	Power(VA)	Phase	Height
IT7622	150/300	6/3	750	1 ϕ	3U
IT7624	150/300	12/6	1.5K	1 ϕ	3U

Model	Voltage(V)	Current(A)	Power(VA)	Phase	Height
IT7625	150/300	36/18 (1Φ) 12/6 (1Φ)	4.5K	1Φ/3Φ	15U
IT7626	150/300	24/12	3K	1Φ	6U
IT7627	150/300	72/36 (1Φ) 24/12 (3Φ)	9K	1Φ/3Φ	27U
IT7628L	150/300	108/54 (1Φ) 36/18 (3Φ)	13.5K	1Φ/3Φ	37U
IT7628	150/300	144/72 (1Φ) 48/24 (3Φ)	18K	1Φ/3Φ	37U
IT7630	150/300	72/36	27K	3Φ	27U*3
IT7632	150/300	96/48	36K	3Φ	27U*3
IT7634	150/300	120/60	45K	3Φ	37U*3
IT7636	150/300	144/72	54K	3Φ	37U*3

Note

When IT7600 series power supplies are in three-phase control, only AC output mode is supported.

2.2 Front Panel Introduction

Different models of IT7600 Series power supply have different front panels. The front panel of IT7626/IT7627/IT7628/IT7630/IT7632/IT7634/IT7636 is as shown below. IT7622/IT7624/IT7625/IT7628L model has the same front panel as IT7626/IT7627/IT7628/IT7630/IT7632/IT7634/IT7636 model except over-current protection output terminal and output terminals.

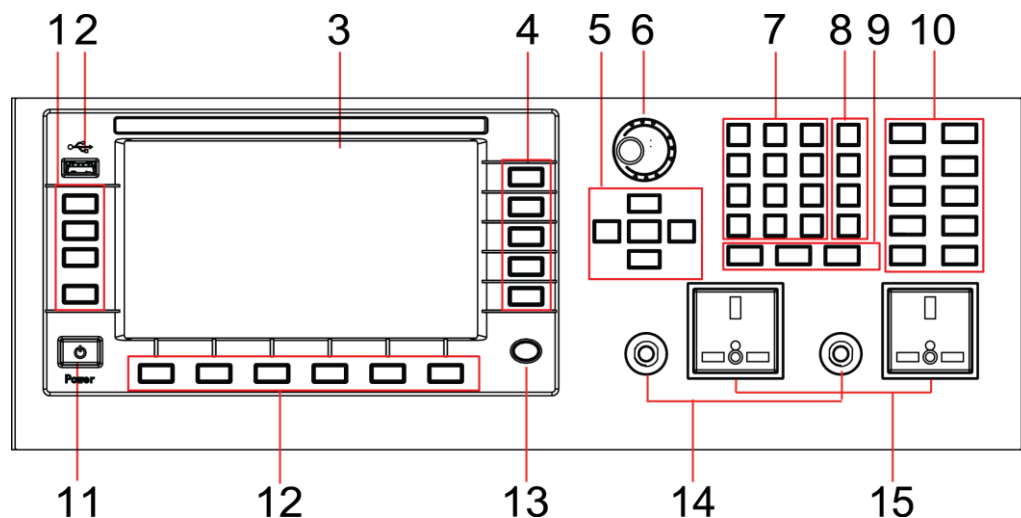

- | | |
|--|---|
| 1 Operation buttons | 2 USB interface |
| 3 LCD display | 4 Menu soft key |
| 5 Up, down, left and right key and enter key | 6 Rotary knob |
| 7 Number key | 8 M1-M4 multi-function keys |
| 9 Esc key, Clear key and Enter key | 10 Function key |
| 11 Power Switch | 12 Menu soft key |
| 13 Home key | 14 Overcurrent protection output terminal |
| 15 Output terminals | |

2.3 Key introduction

The key functions of the front panel and the keys in the key zones of IT7600 series are shown in the following figure.

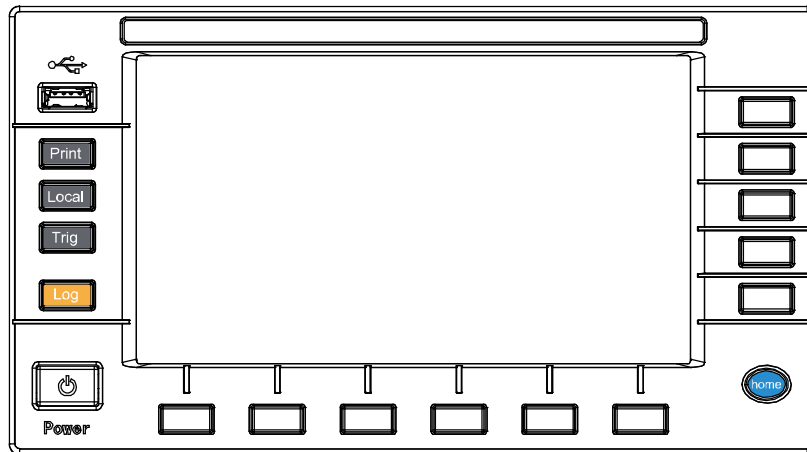





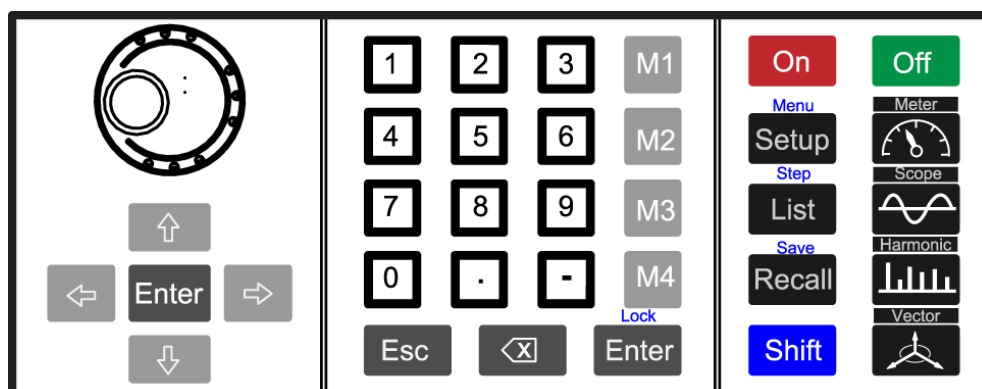

Key description, see the table below:

Key Symbol	Name & Function
Print	Used for saving screen images
Local	Used for switching the remote control mode to the local mode
Trig	Used for manual trigger.
Log	Used for recording data. The recording interval can be set in second
Power	Power Switch
Home	Used for going back to home page
F1-F6 R1-R5	Soft keys for corresponding screen menu operations



Key description, see the table below.

Key Symbol	Name & Function
	Rotary knob: used for setting the value indicated by the cursor, selecting the voltage and current range, adjusting the waveform, etc.

Key Symbol	Name & Function
	Up/Down key and Left/Right key List Edit: those lines which are not displayed can be displayed by operating the Left/Right key. Those rows which are not displayed can be displayed by operating the Up/Down key. Menu Edit: the programming items can be rolled by operating the Up/Down key. Prompts of corresponding options are displayed on the right and options can be selected via the soft key. Digit Edit: the programming items can be rolled by operating the Up/Down key. The digit to be edited is selected by operating the Left/Right key or via the knob. Carrying can be completed automatically.
Enter	Enter key, used for confirming the message
0 to 9	Number key. Enter the number directly
M1 to M4	Recall the setup from internal memory stored in Save1 to 4 for convenience. Press [Shift] + [M4] to exit protection mode.
Enter/Lock	Enter key / keypad lock function keys, used to lock the panel buttons
Esc	Cancel/Esc key
	Used to delete the input digits in the digit editing mode.
On	Used for enabling the power function and input.
Off	Used for disabling the power function and input.
Setup/Menu	Setting key / Menu key, enter the System Menu and set the configuration parameters of various functions
List/Step	List function key, edit the list file / Step function key
Recall/Save	Recall the setup from internal memory/ Store the AC source settings in non-volatile memory.
Shift	Compound key, co-work with Lock/Menu/Step/Save and M4.
 /Meter	Basic metering key used for basic metering.
 /Scope	Waveform Display key When this key is pressed, the waveform corresponding to current measurement data will be displayed.
 /Harmonic	Harmonic Measurement key When this key is pressed, the harmonic measurement results and the menu of harmonic measurement parameter configuration will be displayed.
 /Vector	Vector key When this key is pressed, the vector graph to current measurement data will be displayed.

2.4 Introduction to Information on the Interface



















Early on, and the following main interface of IT7600 series AC source will appear.



Parameter	explain
Current Mode	Operating mode: Single mode/Parallel mode <ul style="list-style-type: none"> ● Select To Parallel ● Select To 3-Phase
Mode	Support AC/DC/ACDC mode
Range	Selection of output range, including auto range, high range and low range.
Wave	Waveform display. There are five waveform can choose, as shown below: <ul style="list-style-type: none"> ● Sine: Sine wave ● Square: Square wave ● Sawtooth: Sawtooth wave ● Triangle: Triangle wave ● THDWave: THD wave

2.5 Introduction to Interface Symbols

The interface of IT7600 power supply will display the following symbols. All the symbols and description are listed in the table below.

Char	Function description	Char	Function description
Shift	Compound key		OTP
	Key operation is locked		OLP
	The AC source is in remote mode		DC mode
	Calibration		AC mode
	Record log		AC+DC mode
	Transformer accessories		External Simulation Test Function
	Switch controller accessories		Three phase mode
	RMS OCP		Parallel mode
	OPP		USB
	PEAK OCP	-	-

2.6 Rear Panel Introduction

- The rear panel of IT7622/IT7624 is shown in the next figure.

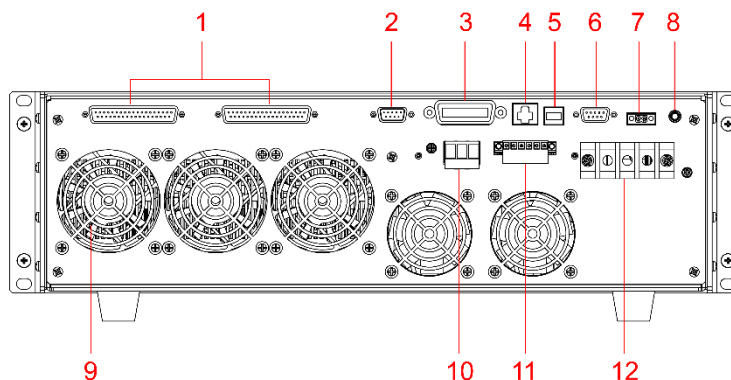

- | | |
|---------------------------------|--|
| 1 System bus | 2 External simulation control terminal |
| 3 GPIB communication interface | 4 LAN communication interface |
| 5 USB communication interface | 6 RS232 communication interface |
| 7 CAN communication interface | 8 Ground screw |
| 9 Vent hole | 10 Power output terminals |
| 11 Remote measurement terminals | 12 AC power input terminals |

- The rear panel of IT7626 is shown in the next figure.

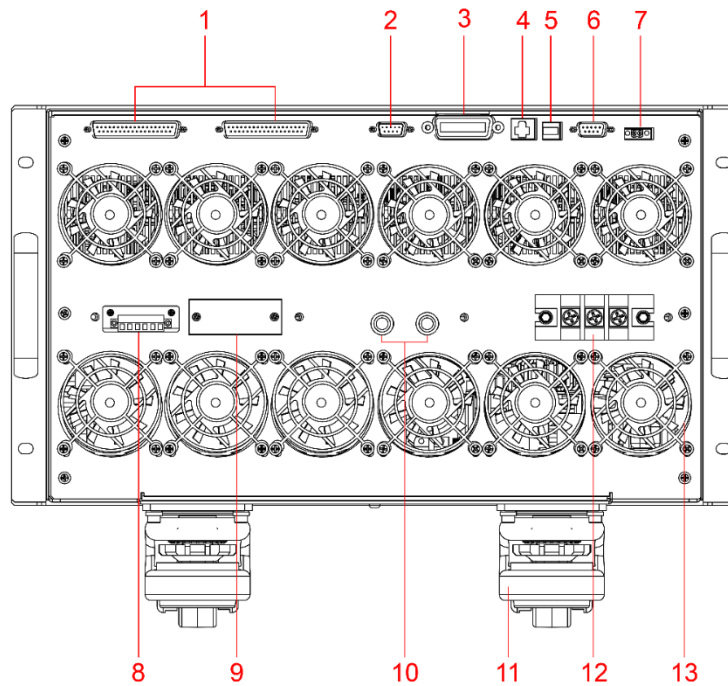

- | | |
|--------------------------------|--|
| 1 System bus | 2 External simulation control terminal |
| 3 GPIB communication interface | 4 LAN communication interface |
| 5 USB communication interface | 6 RS232 communication interface |
| 7 CAN communication interface | 8 Remote measurement terminals |
| 9 Power output terminals | 10 Fuses |
| 11 Instrument roller | 12 AC power input terminals |
| 13 Cooling fans | |

- The rear panels of IT7625/IT7627/IT7628/IT7628L/IT7630/IT7632/IT7634/IT7636 are similar. Take the example of IT7625, the rear panel introduction is shown in the next figure.

Before connecting the communication terminals, you need to take apart the rear panel which covers the communication terminals by using a screwdriver. The communication terminals are the same as that of IT7624/IT7626.

Before connecting the power output terminals and AC power input terminals, you also need to take apart the rear panel which covers them by using a screwdriver.

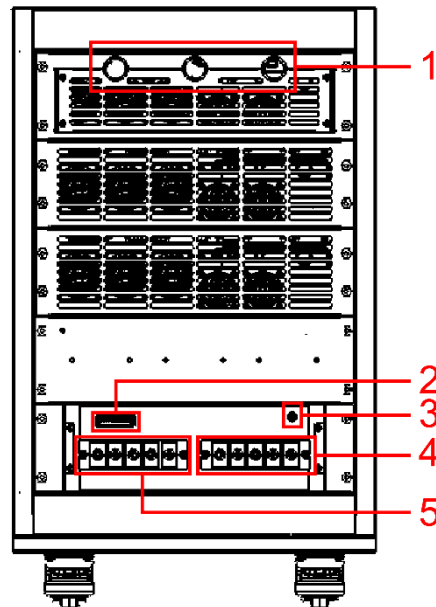

- | | |
|--|--------------------------------|
| 1 Communication interface threading hole | 2 Remote measurement terminals |
| 3 Ground screw | 4 AC power input terminals |
| 5 Power output terminals | |

- The rear panels of IT7630/IT7632/IT7634/IT7636 are similar. Take the example of IT7632, the rear panel introduction is shown in the next figure.

IT7630 series power supply consists of three cabinets. The cabinet with front panel is the system master and others are slaves.

Before connecting the communication terminals, you need to take apart the rear panel which covers the communication terminals by using a screwdriver. The communication terminals are the same as that of IT7626.

Before connecting the power output terminals and AC power input terminals, you also need to take apart the rear panel which covers them by using a screwdriver.

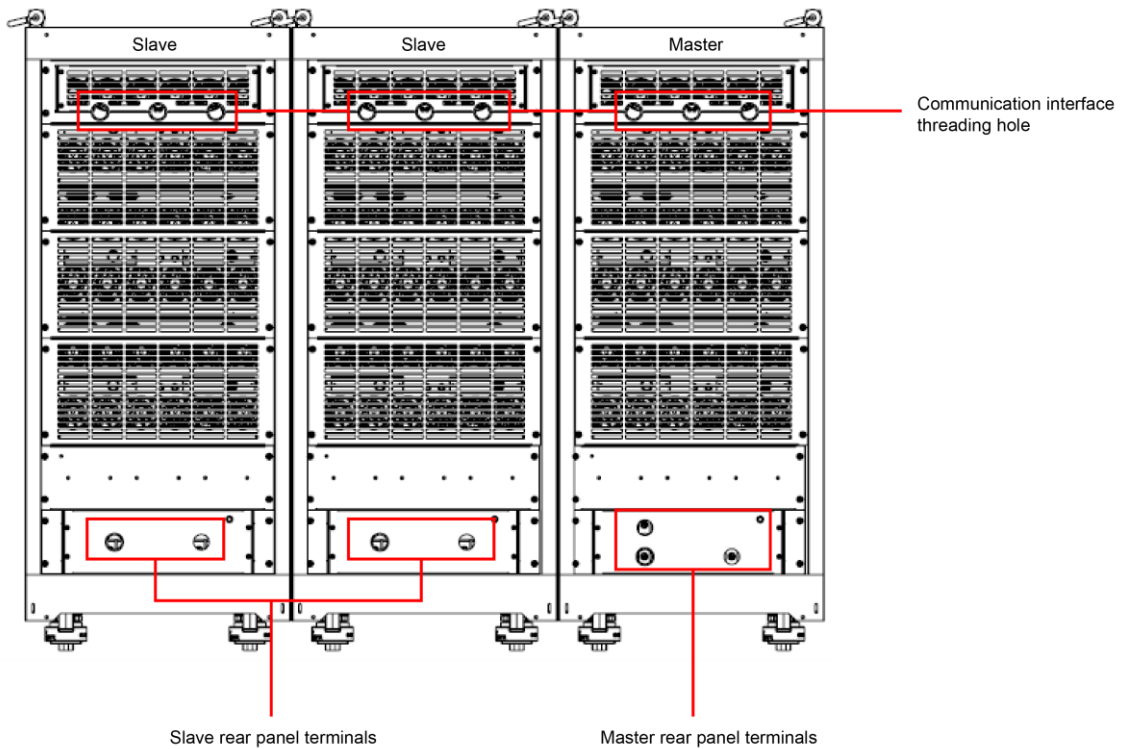

◆ The master rear panel terminals are introduced as follows.

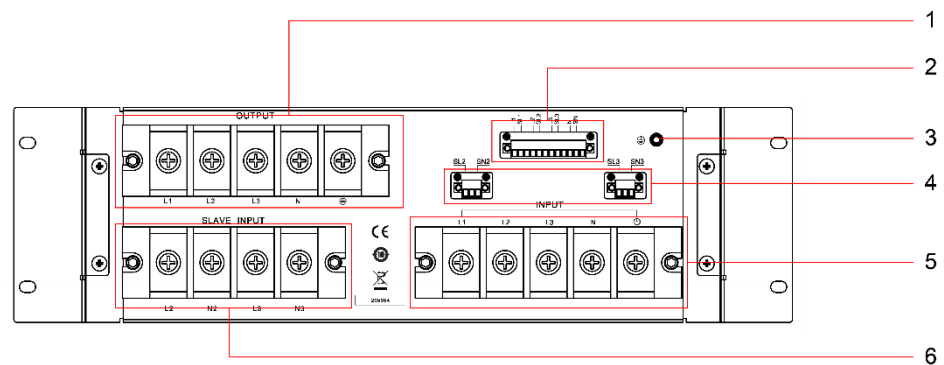

1 power output terminals

3 Ground screw

5 AC power input terminals

2 Remote measurement terminals

4 Parallel remote measurement terminals, used to connect with slave remote measurement terminals

6 Parallel input terminals, used to connect with slave power output terminals

- ◆ The slave rear panel terminals are introduced as follows.

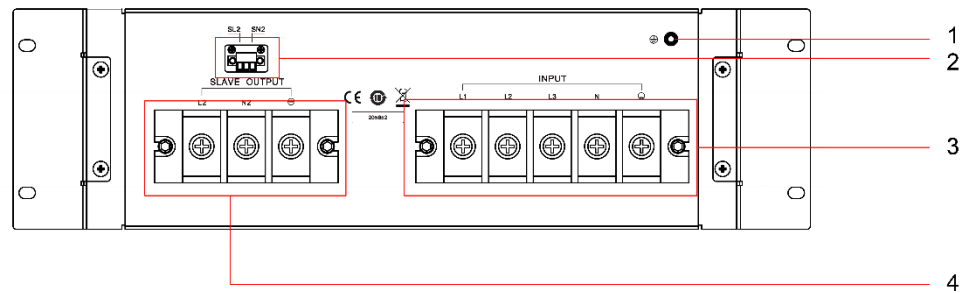

- 1 Ground screw
- 2 AC power input terminals
- 3 Slave remote measurement terminals
- 4 Slave power output terminals

2.7 Power-on Selftest

A successful selftest indicates that the purchased power product meets delivery standards and is available for normal usage.

Before operation, please confirm that you have fully understood the safety instructions.

WARNING

- To avoid burning out, be sure to confirm that power voltage matches with supply voltage.
- Be sure to connect the main power socket to the power outlet of protective grounding. Do not use terminal board without protective grounding. Before operation, be sure that the power supply is well grounded.

2.7.1 Power Switch Introduction

User can press the power switch of IT7600 series power supply directly to turn on or turn off the instrument.

The status of Power switch is as follows.



2.7.2 Power-on Selftest

Normal selftest procedures:

1. Correctly connect the power cord. Press Power key to start up.
The power supply will do selftest.

2. After initialization, the LCD screen displays the following information.

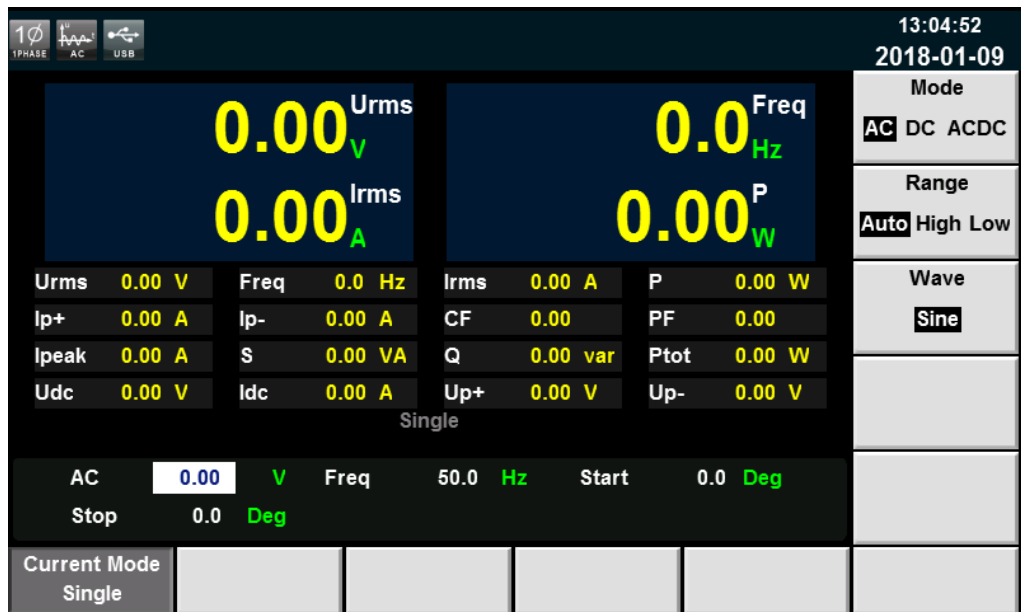

NOTE

In case of any error, self-test will stop. Contact ITECH distributors or technical service engineer.

3. Press **[Shift] + [Setup]** (Menu), and the LCD screen of the AC source displays the system information.

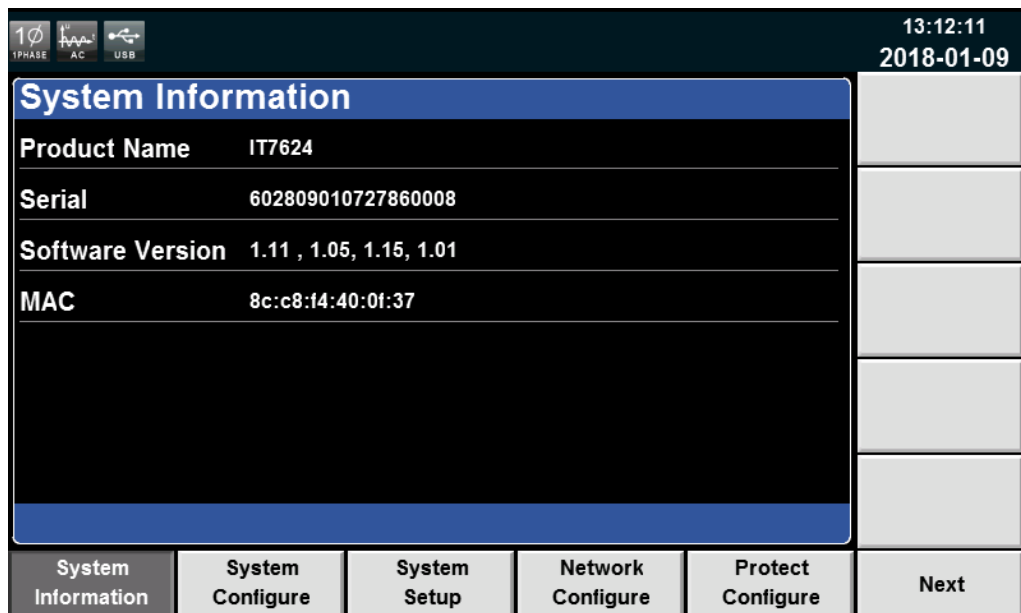

During self-test of the power supply, if EEPROM has error, the “Error” indicator on the status bar lights up.

2.7.3 System Self-Test

The self-test function of the AC Power Supply can be enabled to check the Lcd Test, Key Test, Dsp Test, BackRam Test and Fan Test. Specific steps are as follows:

1. Press **[Shift] + [Setup]** (Menu) to enter.
2. Press **[Next]** in this interface, and the system menu is scrolling.
3. Select **[Device Self-Test]** in this interface, and the system enters the self-test interface.

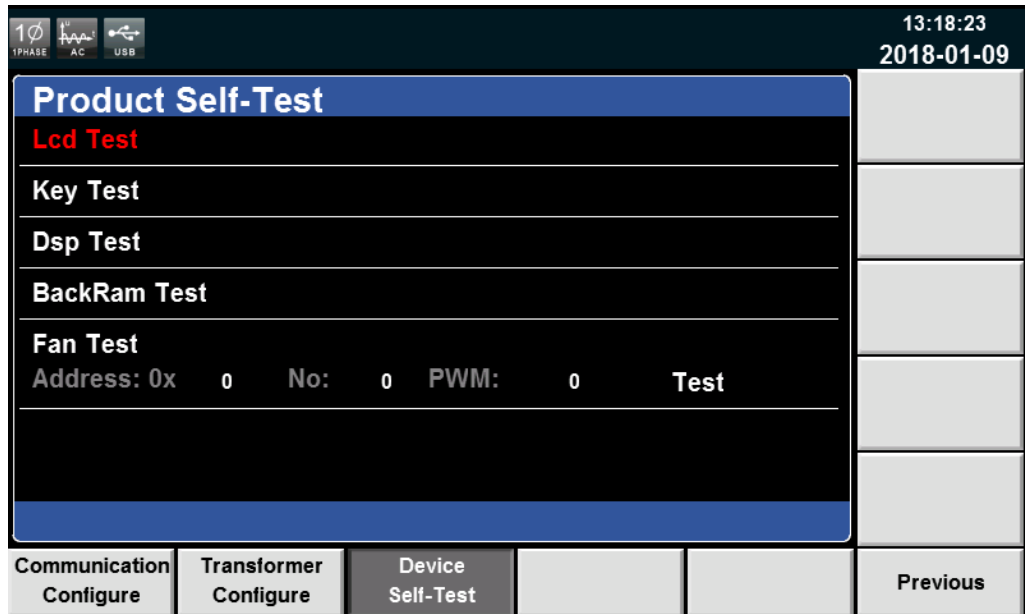

4. Press **[Enter]**, the system starts self-test. If 'LCD Checking Finish' displays on the screen, LCD has passed self-test.
5. Press the down arrow keys to select Key Test. Press **[Enter]**. Operate according to tips on the screen. Press **[Esc]**. If 'Key Checking Finish' displays on the screen, Key has passed self-test.
6. Press the down arrow keys to select Dsp Test. Press **[Enter]**. If 'Dsp Ok' displays on the screen, Dsp has passed self-test. The self-test operation of BackRam is similar to that of Dsp.
7. Press the down arrow keys to select Fan Test. Set fan parameters according to the following table.

Parameter	Description
Instrument address (Address: 0x)	Set the instrument address. <ul style="list-style-type: none"> ● There's no need to set the address for single instrument. ● In parallel control, set the master address to 0, and the slave address follows in order: 1, 2, 3..... ● In three-phase parallel control, set the master address of phase A to 0 and the slaves address of phase A follows in order: 1, 2, 3.....Set the master address of phase B to 41 and the slaves address of phase B follows in order: 42, 43.....Set the master address of phase C to 81 and the slaves address of phase C follows in order: 82, 83.....
Fan position (No:)	You can set fan position to 0 or 1. Each value is corresponding with a fan position.

Parameter	Description
Duty cycle (Pulse-Width Modulation)	Duty cycle determines the fan speed. The larger the duty cycle is, the faster the fan speed is. The value of the duty cycle must be integer and in the 0 to 100 range.

- Press the down arrow keys to select 'Test', and press **[Enter]**. Then the fan starts to self-test. Observe the fan rotating to judge the working state. Press **[Enter]** again to close the fan self-test.

Exception handling

If the power supply cannot start normally, please check and take measures by reference to steps below.

- Check whether the power cord is correctly connected and confirm whether the power supply is powered.

Correct wiring of power cord => 2

Incorrect wiring of power cord => Re-connect the power cord and check whether the exception is removed.

- Check whether the power in On. Power key is under “” On status.

Yes => 3

No => Please check the Power key to start power and check whether the exception is removed.

- Check whether the fuse of power supply is burned out.

If yes, replace with a fuse of the same specification.

- The fuse of IT7622/IT7624/IT7625 is arranged on the internal circuit board of the machine, and must be replaced by professional personnel.
- Fuse of IT7626/IT7627/IT7628 can unscrew directly by hand. For fuse position, see Introduction of Rear Panel for details. Remove the wiring panel before replacing the fuse of IT7627/IT7628.
- The fuse of IT7628L/IT7630/IT7632/IT7634/IT7636 must be replaced by professional personnel.

Chapter3 Basic Operations

This chapter describes operations of the keys on the front panel of the AC power supply. The AC power supply must be in the local mode when controlled by the front panel. The default mode is the local mode after the AC power supply is turned on. In the local mode, the user can enable all functions of the power supply through the front panel.

3.1 Output On/Off Operation

[On] / [Off] button on the front panel are used to control output switch. [On] button lighted indicates the power supply output is on and the [Off] button lighted indicates the power supply output is off. The initial state of AC source is OFF.



NOTE

Make sure you have connected AC source and DUT very well, then press [On] button to minimize shock hazard.

3.2 AC Output Mode

If user set AC Mode, the instrument will simulate AC power supply. The default set of IT7600 series power supply is AC Mode. Set the output parameters of the power supply in the main interface, including the output voltage, output frequency, output start phase and output stop phase. Select the corresponding parameters by pressing the Up and Down keys on the front panel, as shown in the figure below.

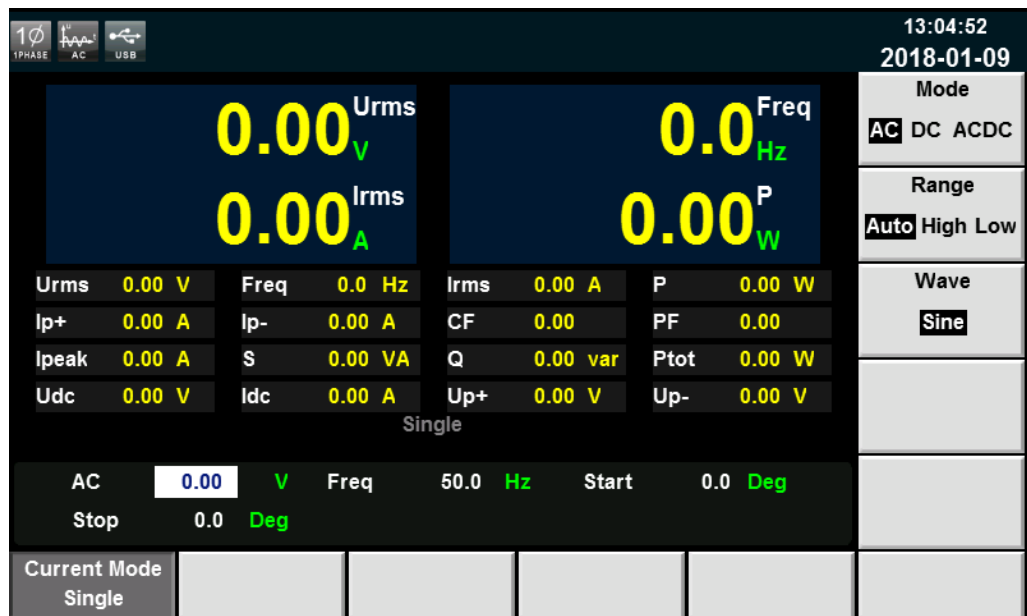

AC: AC voltage value. Setting range is different among Auto, High and Low range. Refer to 9.1 Main technical parameters for more details.

Freq: Frequency with range of 10Hz to 5KHz.

Start: Start phase angle

Stop: Stop phase angle

3.3 DC Output Mode

If user set DC Mode, the instrument will simulate DC power supply. Set the output voltage of the DC power supply in the main interface, as shown in the figure below.

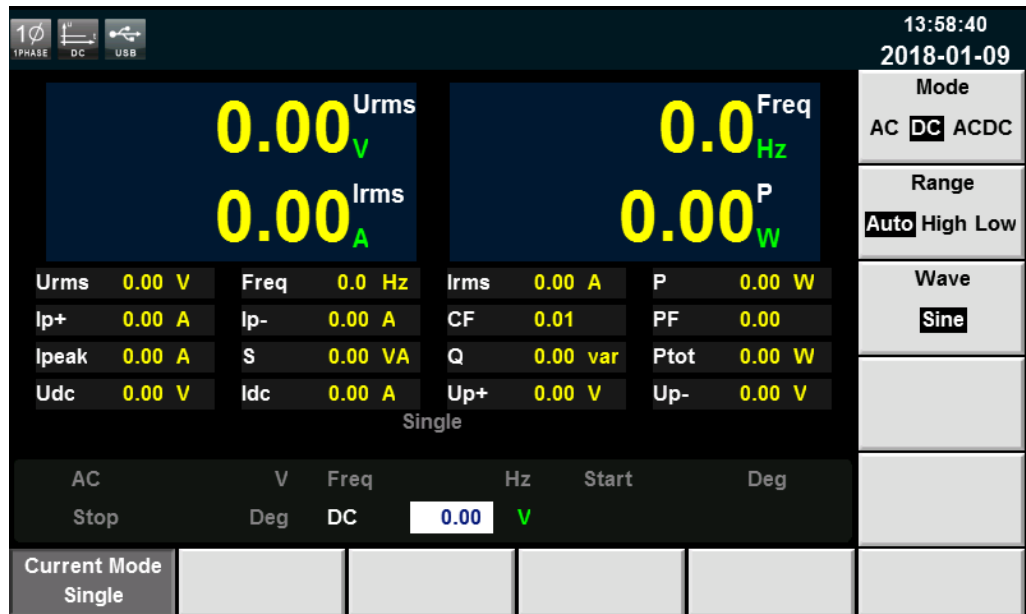

DC: DC voltage value. Setting range is different among Auto, High and Low range. Refer to 9.1 Main technical parameters for more details.

3.4 ACDC Output Mode

If user set ACDC Mode, the instrument will simulate AC and DC power supply, which can add DC component to AC voltage. Set the output voltage in the main interface, as shown in the figure below.

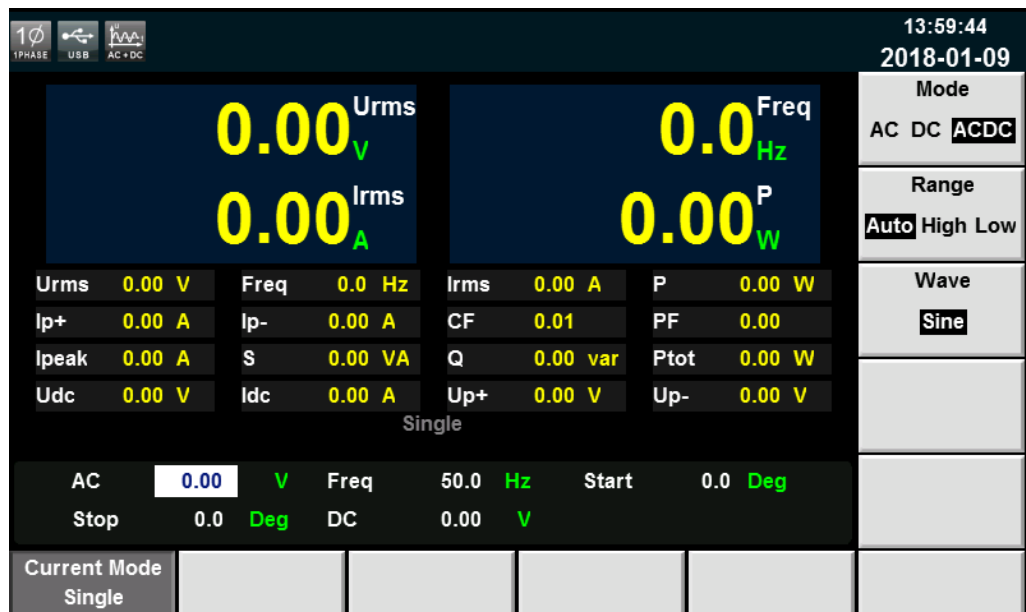

3.5 Switching Output range

IT7600 series AC source will allow switchover between High range Low range and Auto range.

User can choose the range according to actual test requirements, when High range is selected, voltage setting value is under high level. When Low range is selected, voltage setting value is under low level (refer to 9.1 Main technical parameters for more details). If the auto range is selected, the instrument will automatically switch to high level or low level, thus sparing complicated operations such as manual setting.



NOTE

There is a temporary OFF to the AC source during the switchover of range.

3.6 Waveform Selection

The user can set the output waveform in the main interface of IT7600 series power supply. Five output waveforms below are available:

- Sine
- Square
- Sawtooth
- Triangle
- THDWave

When **THDWave** is selected, the user should configure the distortion waveform. (Refer to 8.4 THD Wave for more details.)

3.7 Sweep function

The Sweep function is used to test efficiency of switching power supply and capture the voltage and frequency at the maximum power point. The voltage and frequency of power may be altered in the form of step ladder by setting the initial voltage, final voltage, step voltage, initial frequency, final frequency, step frequency and one-step time. As the test closes, voltage and frequency at the maximum power point may be displayed. Sweep function is not applicable under DC mode and ACDC mode. And the sweep waveform is sine wave.

Operating steps

1. Press **[Shift] + [List]** (Step) on the front panel to enter the sweep interface, as shown in the figure below.



Soft Key of Menu	Description
Step Mode	Sweep mode Time: Time Sweep Mode Trig: Trigger mode
Priority	Priority setup: voltage or frequency.

- Set the voltage and frequency parameters in the sweep interface.

Parameters in the sweep interface are described as follows:

Parameter	Explain
V-Start	Set the starting voltage.
V-End	Set the ending voltage.
V/Step	Set the step voltage.
T/Step	Set the step time.
F-Start	Set the starting frequency.
F-End	Set the ending frequency.
F/Step	Set the step frequency.
Repetition	Set the sweep cycles.

- Press **[On]** on the front panel. Then the measured value will be displayed on LCD.
- After sweeping, **[On]** on the front panel will be disabled, and **[Off]** will be enabled.

3.8 Key Lock Function

Press **[Shift] + [Enter]** (Lock) button to set the key lock state. If keyboard has been locked, the indicator light "Lock" will display on the LCD. In addition, when keyboard are locked, all buttons can't be used except Local key Press **[Shift] + [Enter]** (Lock) once again will relieve key lock function.

3.9 Switching Local/Remote Mode

You can press the local button to change the AC source from remote to local operation.

After you power on the AC source, it defaults in local mode, all buttons are enabled. While in remote mode, most buttons are disabled except Local keys. You can switch Local/Remote mode via PC. In addition, the mode modification will not affect the output parameters.

3.10 Menu Operation

3.10.1 Menu description

Press the composite key **[Shift] + [Setup]** (Menu) to enter the menu function. At this time, LCD displays optional menus. Operate the menu by pressing soft keys. Select and edit the menu items by pressing the Up, Down, Left and Right keys. Specific menu items are shown below.

MENU			
System Information	System Information		
		Product Name	Instrument Name
		Serial	Instrument SN
		Software Version	Instrument Version
		MAC	Software MAC address
System Configure	System Configure		
		Date(YY/MM/DD)	System date: Year/Month/Day
		Time(hh:mm:ss)	System time: Hour/Minute/Second
		Brightness	Set the screen brightness.
		Beeper	Set the keyboard sound ● ON: Buzzer on ● OFF: Buzzer off
		System Reset	System Reset
		Posetup	Set the Power ON/OFF state after power up. ● RST: Factory Default ● SAV0: The preset parameter stored in Save0.
	Logger Interval	Logger storage interval	
System Setup	System Setup		
		Trig Source	Set the trig source: ● Key ● Software ● Bus ● External
		Loop Speed	Output loop speed control, with two options: ● Slow: Slow speed ● Fast: fast speed Control the loop stability. If the capacitive or inductive load is connected, select

			“Slow”. If the resistive load is connected, select “Fast”.
		Ext-Ctrl	External simulation test: <ul style="list-style-type: none"> ● On ● Off
		Relay Ctrl	Relay control: <ul style="list-style-type: none"> ● Close: normally closed, for access to the user’s circuit ● Open: normally open, for isolation of the user’s circuit The default is Open.
Network Configure	Network Configure		
		Network Mode	Master/Slave mode: <ul style="list-style-type: none"> ● Master: Set the Master mode ● Slave: Set the slave mode
		Network Type	Network Type: <ul style="list-style-type: none"> ● 1: Parallel ● 2: Three-phase
		Network Num	Set the network number
Protect Configure	Current Protect		
		Current RMS	Set the current RMS
		Current PEAK	Set the current PEAK
		Time	Immediate protection of effective or peak current: <ul style="list-style-type: none"> ● IMME: immediate protection. ● TIME: current protection after the delay Time, in s.
Communication Configure	Communication Config		
		Current Comm	Interface, with the following drop-down options: <ul style="list-style-type: none"> ● RS232 ● USB ● GPIB ● LAN ● CAN
		RS232 Baudrate	Set the Baudrate
		GPIB Address	GPIB address setting
		IP Mode	IP Mode: Static/DHCP
		IP Address	IP address setting
		MASK	Set the mask
		Gateway	Set the gateway.
		Socket port	Set the socket port
		Can Parameter	Setting
			Prescaler: set the Prescale
			Bit Segment1: range from 0 to 16.
		Bit Segment2: range from 0	

			to 8.
			Can ID: set Can address.
Transformer Configure	Transformer Setup		
		Transformer Machine	Display the transformer model
		Transformer Software	Display the transformer software version number
		Transformer Sn	Display the transformer serial number
		Transformer V-Abudhabi	Display the transformer voltage turns ratio
		Transformer C-Abudhabi	Display the transformer current turns ratio
		Transformer State	Display the transformer mode, state and temperature information. Working mode: <ul style="list-style-type: none"> ● Set-up ● Bypass Working state: <ul style="list-style-type: none"> ● Normal ● Fault
		Transformer Function	Set the transformer function: <ul style="list-style-type: none"> ● Enable ● Disable
		Transformer Fan	Set the transformer fan speed: <ul style="list-style-type: none"> ● Auto: automatically adjust the fan speed ● PWM: manually set the duty ratio.
Device Self-Test	Product Self-Test		
		Lcd Test	Lcd Test
		Key Test	Key Test
		Dsp Test	Dsp Test
		BackRam Test	BackRam Test
		Fan Test	Fan Test

3.10.2 Menu function

System Information

The item "System Information" provides the instrument information, as shown in the table below. The following table is as an example.

Product Name	IT7626
Serial	602807022717630005

Software Version	0.12,0.16,1.03,1.11
MAC	00: 17: 18: 01: 0f: 5c

Set the screen brightness (>Brightness)

This item can set the screen brightness. Set the screen brightness within the range 1 to 10 by pressing number keys on the front panel. The larger the number is, the higher the screen brightness is. You can also set the screen brightness by rotating the knob on the front panel.

Set the keyboard sound (>Beeper)

This item can set the key sound state. If in ON mode, then when you press a button, the power supply will beep. If in OFF mode, the beeper will not make a sound. The default set is in ON mode.

Set the Power ON/OFF state after power up (>Posetup)

This parameter determines the state of the AC source after power up. If you select "Rst", the default output parameter settings will be active after power up. The default setup is 0V, 50HZ, 0° and 0°. If you select "Sav0", then the AC source will automatically recall the output parameters setting saved in 0 register.

Set the Loop Speed (>Loop Speed)

This item can control stability of the loop. When the connected load is capacitive load or inductive load, select Slow; when the connected load is resistance, select Fast.

Set the Relay (>Relay Ctrl)

This item can isolate or connect the user loop. When Close is selected, the relay is closed, and the user circuit can be connected; if Open is selected, the relay is open, and the user circuit is isolated.

Network Configure (>Network Configure)

This item can set the network type and corresponding network quantity. Two network types are available:

- 1: Parallel mode.
- 2: Three-phase mode, corresponding to 3 or more networks.

The user can select the corresponding mode by pressing number keys on the front panel, and determine the network quantity according to actual conditions.

Set the communication interface (>Communication)

This item can set communication modes of the AC power supply. IT7600 Series has the following standard communication interfaces: RS232/USB/GPIB/LAN/CAN. You can choose any one of them to communicate. When communication with computer, you need to select a communication interface and set its corresponding configurations so that the communication settings of the power supply are same with the PC configurations.

- RS232 Baud rate: 4800/9600/19200/38400/57600/115200.
- USB communication interface

- The address range of GPIB is 1 to 30.
- LAN parameters include Gateway address (Gateway), IP address (IP), Mask address (Mask) and port (Socket Port).the IP address and Socket Port should be consistent with that of the PC address and port Number.

3.11 Transformer Function

When using the transformer function, the user needs to connect the IT-E760 series transformer accessory. If the IT7600 series power supply is used with the IT-E760A series boost transformer module, the output voltage will rise from 300 V to 600 V. IT-E760 series transformer accessory is an accessory provided by ITECH for this power supply. You can select the transformer accessory based on power supply model. Please refer to IT-E760 Series User Manual for more description of the transformer accessory.

The operation steps to enable the transformer function are as follows.

1. Press **[Shift] + [Setup]** (Menu) to enter in to the main interface.
2. Press **[Next]** to turn the page of the system menu.
3. Select **[Transformer Configure]** and enter into the transformer interface, shown as follow.

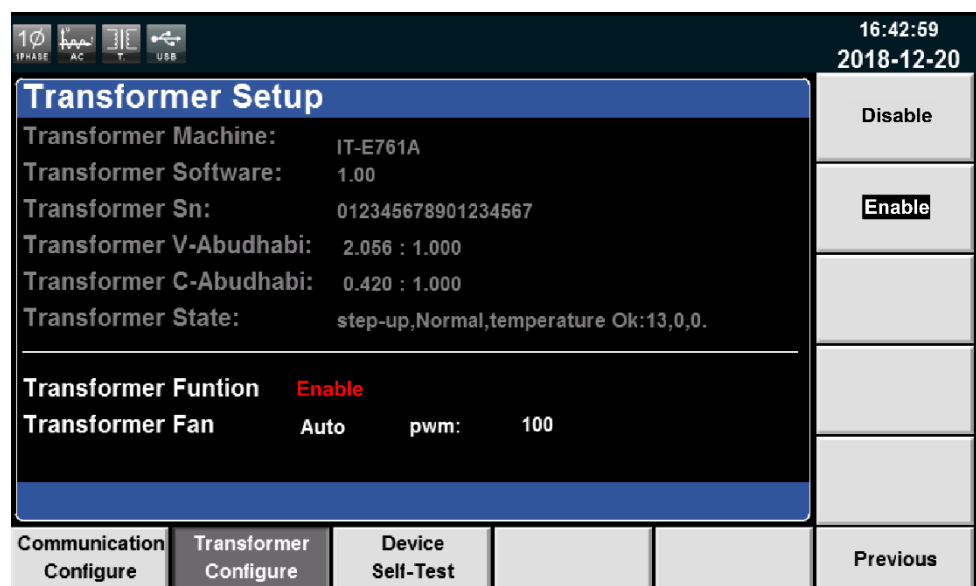

4. Press **[Enable]** to turn the transformer function on.
5. Set the transformer fan speed according to requirement.

3.12 Configuration Save/Recall Function

Press **[Shift] + [Recall]** (Save) on the front panel of the power supply to save all the current parameters in the ten nonvolatile memory groups. The user can press **[Recall]** to easily and rapidly recall the parameters from Save0 to Save9.

Recall the setup from internal memory stored in Save1 to Save4 for convenience by pressing **[M1] ~ [M4]**.

3.13 Protection Function

IT7600 series source includes the following protection functions: overcurrent

protection (Peak OCP, Rms OCP), over-temperature protection (OTP), over-power protection and over-load protection.

Overcurrent protection (OCP)

- Peak overcurrent protection (Peak OCP)

When the output current exceeds the set peak current, Peak OCP will be enabled, and  will appear on the LCD screen. When the RMS overcurrent protection is disabled, the OC status in the status register will be reset.

Clearing overcurrent protection:

In the case of overcurrent protection, disconnect the tested object at first. Press **[Shift] + [M4]** on the front panel (or send the command “PROTection:CLEar”) to clear “Peak OCP” on the front panel and exit the Peak OCP mode.

- Rms OCP

When the output current exceeds the set Rms current, Rms OCP will be enabled, and  will appear on the LCD screen. When the peak current protection is disabled, the OC status in the status register will be reset.

Clearing overcurrent protection:

In the case of overcurrent protection, disconnect the tested object at first. Press **[Shift] + [M4]** on the front panel (or send the command “PROTection:CLEar”) to clear  on the front panel and exit the Rms OCP mode.

Setting of protection function

1. Press **[Shift] + [Setup]** (Menu) key to enter.
2. Press **[Protect Configure]** in the interface to enter the “Current Protect” interface, where you can set the following protection.

Protection Type	Upper Limit	Immediate protection	Delay Time
Current RMS	RMS current for OCP protection	When the circuit current exceeds the set effective/peak value, OCP protection will be enabled immediately.	Overcurrent time: when the actual time exceeds the delay time, the protection will be enabled. The maximum delay time is 5s.
Current PEAK	Peak current for OCP protection		

3. Press **[Shift] + [Recall]** (Save) to save the settings. In this case, the prompt “Configure Success” will appear on the interface. If **[Shift] + [Recall]** (Save) are not pressed, the configured parameters will be invalid.

Over-temperature protection (OTP)

When the temperature of the power component in the power supply exceeds 95°C, the temperature protection will be enabled. In this case, the power supply

will be automatically OFF, and the LCD will display . At the same time, the OT position in the status register will be set and kept until power supply is reset.

Clearing over-temperature protection:

When the power supply temperature decreases to the protection temperature, press **[Shift] + [M4]** key on the front panel (or send the command “PROTection:CLEAr”). Then  on the power supply screen will disappear, and the power supply will exit the OTP status.

Over-power protection (OPP)

When the output power exceeds the set power, OPP will be enabled, and  will appear on the LCD screen.

Clearing over-power protection:

In the case of over-power protection, disconnect the tested object at first. Press **[Shift] + [M4]** on the front panel (or send the command “PROTection:CLEAr”) to clear  on the front panel and exit the OPP mode.

Over-load protection

When the output load exceeds the set load, OLP will be enabled, and  will appear on the LCD screen.

Clearing over-load protection:

In the case of over-load protection, disconnect the tested object at first. Press **[Shift] + [M4]** on the front panel (or send the command “PROTection:CLEAr”) to clear  on the front panel and exit the OLP mode.

3.14 Data Recording Function

IT7600 series power supply can record the data at intervals. The user can save present measurement data into the peripheral memory disc by pressing **[Log]** on the front panel. All data will be saved in files ending in CSV. Press **[Shift] + [Setup]** (Menu) to enter into **[System Configure]**. Select **[Logger Interval]** to set the recording interval.

3.15 Screen Capture Function

IT7600 series power supply has the screen capture function. Insert the USB equipment into the USB interface of the front panel, and press **[Print]** on the front panel to capture and save the current screen into the peripheral USB memory.

3.16 Trigger Function

IT7600 series has four trigger source to choose: trigger by keys (Key), Software trigger (Software), Bus trigger (Bus) and External signal trigger (External).

- Key: if **[Trig]** on the front panel is pressed in the valid key trigger mode, the power supply will be triggered once.
- Software: if the trigger command is received by the power supply from the communication interface in the valid software trigger mode, the power

- supply will be triggered once.
- Bus: if the bus trigger command is received by the power supply in the valid bus trigger mode, the power supply will be triggered once.
- External: if one trigger signal is connected to the pin 9 of the Analog Interface terminal on the rear panel, the power supply will be triggered once.

3.17 External Simulation Test Function

The rear panel of the power supply is equipped with a DB-9 simulation interface used for controlling the on-load voltage. The adjustable voltage (0V to 10V) can be connected to the simulation interface to simulate the output from 0% to 100% of the full range, thus adjusting the output voltage.

Press **[Shift] + [Setup]** (Menu) to enter the **[System Setup]** interface. Select

Ext-Ctrl and set it in the **ON** state. Exit the menu. Then  will appear on the LCD screen. Press **[Home]** on the front panel to exit the external simulation function. External simulation function is not applicable under ACDC mode.

DB-9 terminal is defined as follows.



Pin	Name	Instruction
Pin 1	V-MON (Voltage monitoring)	The voltage value (AC: 0V to 10V; DC: -10V to +10V) from monitoring is the corresponding output voltage value of the power supply.
Pin 2	Vexter (External reference input)	The output voltage value of power supply is subject to the simulation voltage. The input analog range should be 0 to 10V, and the regulated output voltage should be from 0% to 100% of the full range.
Pin 3	ONOFF_STATE	Output the ON/OFF state. Used for indicating whether the power output is normal; if so, output 5V; in case of power supply failure, output 0V.
Pin 4	TRIG_OUT	Trigger output signal, used in the list function. If the triggering type of a list step is set to TRIG, this pin will output a high pulse signal when the list file runs from this step to the next step.
Pin 5	GND	Digital grounding.
Pin 6	I-MON (Current monitoring)	The voltage value (AC: 0V to 10V; DC: -10V to +10V) from monitoring is the corresponding output current value of the power supply.
Pin 7	GND3	External simulation grounding.
Pin 8	ON/OFF	Used for controlling output Off of the power supply; default setting is high level. When external low level is connected, or when it is short circuited to digital grounding, output is switched off.
Pin 9	EXT TRIG	External trigger control signal input.

External reference input

This function enables change of voltage output through external analog signal by connecting external DC voltage to Pin 2. To enable this function, the output control should be under the external analog control mode. Used for controlling the external voltage range of full-scale output voltage can be selected from 0 to 10V.

The user can set the output voltage value of power supply through Pin 2. The diagram is shown in the next figure.

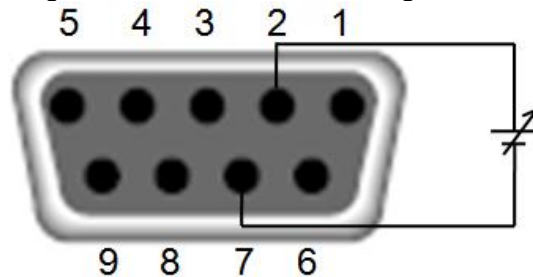

V-MON (Voltage monitoring)

This function enables a digital voltmeter (DVM) to monitor the voltage output by connecting the DVM to Pin1 and Pin7. To use this function, the output control should be under the external analog control mode. The output voltage monitoring range (which reflects the power supply output voltage from zero to full scale) is -10V to +10V in DC and 0V to 10V in AC.

The connection setting of digital voltmeter is shown below.

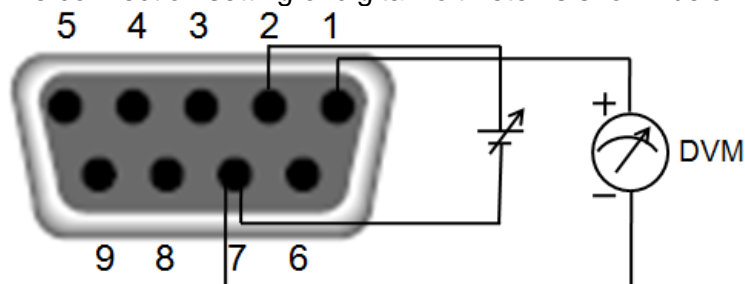

I-MON (Current monitoring)

This function enables a digital voltmeter (DVM) to monitor the current output by connecting the DVM to Pin6 and Pin7. To use this function, the output control should be under the external analog control mode. The output voltage monitoring range (which reflects the power supply output voltage from zero to full scale) is -10V to +10V in DC and 0V to 10V in AC.

The connection setting of digital voltmeter is shown below.

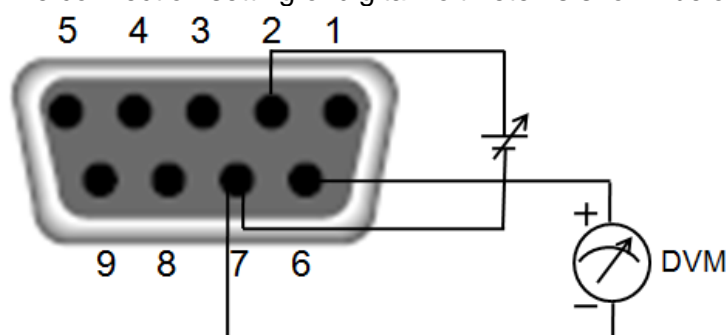

3.18 Remote Measurement Function

If the tested instrument consumes large current, a large voltage drop will be detected in connection line between tested instrument and power supply terminal. To ensure measurement accuracy, a remote sense measurement terminal is provided at power supply rear panel to compensate voltage drop lost in wire. Take the example of IT7626, the remote sense terminal is shown in the next figure.

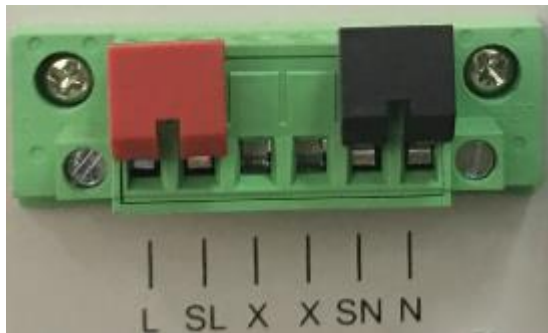

SL, SN: remote sense terminal

L, N: rear panel output terminals, the same as the front panel output terminals.

X: connectionless



NOTE

When the output voltage has DC voltage, the output terminal L is Hi, and N is Lo.

Use remote sense

Use the “Remote Sense” function to compensate the voltage drop of the wire between the rear panel terminal and tested equipment. Operations are as follows:

1. Disconnect the wires/short clips between L and SL, N and SN.
2. Connect the SL to the DUT’s L terminal, and connect the SN to the DUT’s N terminal.
3. Connect one pair of drive wires from the rear panel terminals L and N to the tested equipment.



NOTE

In order to ensure the stability of the system, using armored twisted pair cable between the remote sense terminal of IT7600 and DUT.

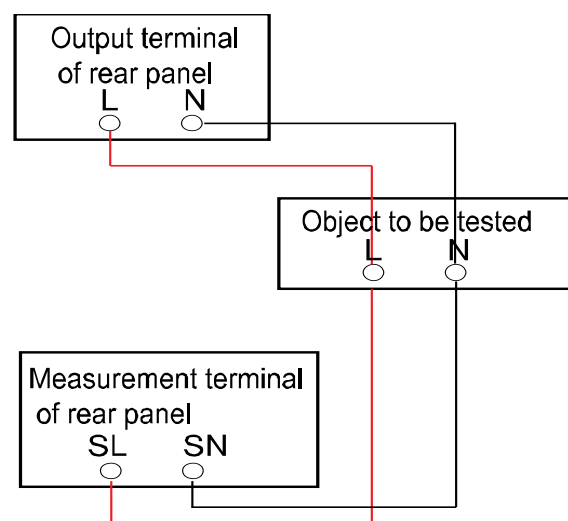

3.19 Parallel Function

IT7600 can be used in parallel connection of multiple units of the same model to test DUT of high power. In parallel applications, the power supply can be connected to 6 units in parallel at most.



NOTE

Only IT7622, IT7624 and IT7626 are with the function.

CAUTION

In Parallel mode, the output power cannot exceed 95% of the total power to avoid loss caused by AC power unbalance.

Take parallel connection of 3 power supplies as an example, the schematic diagram is as follows. Connect the system bus and output terminals of 3 power supplies as shown in the diagram.

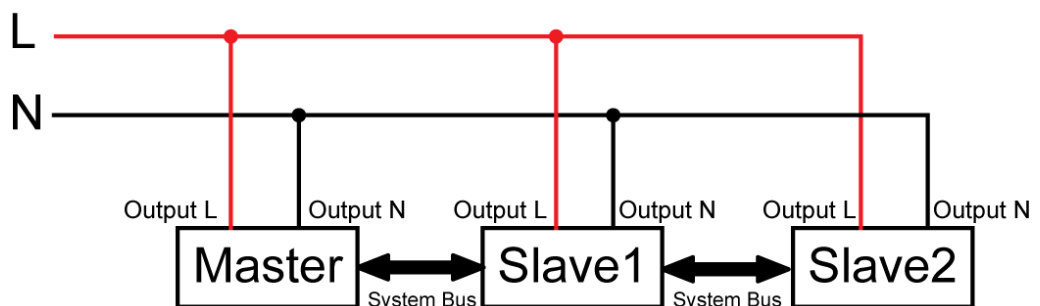

Note

In the parallel-connection mode, you need to disconnect the wires/short clips between L and SL, N and SN, and then connect the SL and SN of three power supplies to DUT when you use the remote measurement function.

Configure the instruments on the front panel after finishing connecting.

In the parallel-connection mode, the master and slaves are determined according to the instrument setting. In parallel connection of three units, if the instrument is set to Master, the present power supply is the master unit, and if the instruments are set to Slave, the power supplies are slaves. The user needs to set the instrument number in master unit to determine the power in the present mode.

When you configure the instrument, slaves should be set with priority to correctly set the total number of parallel instruments during master unit setting. Specific setting steps are as follows.

Select two power supplies as the slaves.

1. Press **[Shift] + [Setup]** (Menu) on the front panel to enter the main interface of the AC power supply.
2. Press **[Network Configure]** to enter the “Network Configure” interface, and set “Network Mode” to Slave. Press **[Enter]** to confirm.

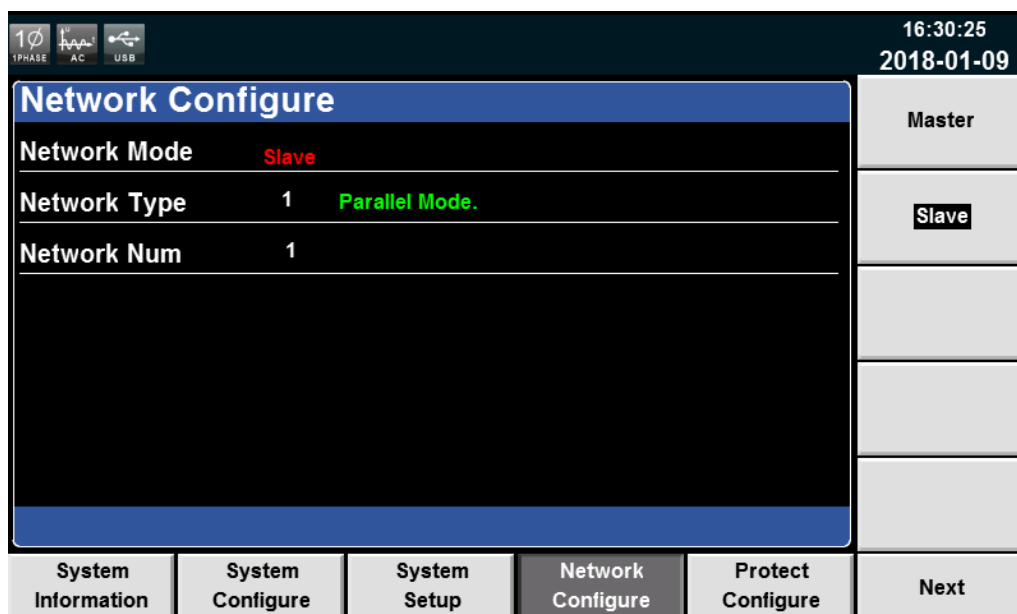

3. Press **[Esc]** to return the main interface. Power off the instrument and then power on again. (It takes about 10s to boot up the instrument.) The slave will display “SLAVE MODE! ” and the slave state is “INIT”.

Select one power supply as the master.

1. Press **[Shift] + [Setup]** (Menu) on the front panel to enter the main interface of the AC power supply.
2. Press **[Network Configure]** to enter the “Network Configure” interface, and set “Network Mode” to Master. Set “Network Num” to 3. Press **[Enter]** to confirm.
3. The interface prompts “Configure Ok!”. The slave state displays “NORMAL”. This means the parallel configuration is successful.

3.20 Three-phase Parallel Function

IT7600 can be used in parallel connection of multiple units to test three-phase AC power supplies. In three-phase parallel applications, according to the actual requirements, the user can connect 3 power supplies to three-phase parallel, or connect multiple power supplies (up to six units each phase) in each phase to increase the output power and current. What’s more, the user can select the Y-type and Δ -type connection according to the actual requirements. Flexible connection can meet various test requirements.



NOTE

Only IT7622, IT7624 and IT7626 are with the function.

One unit each phase

Connect 3 power supplies to three-phase parallel. Take IT7626 as an example, the Y-type and Δ -type connection is shown as below.

- Y-type connection

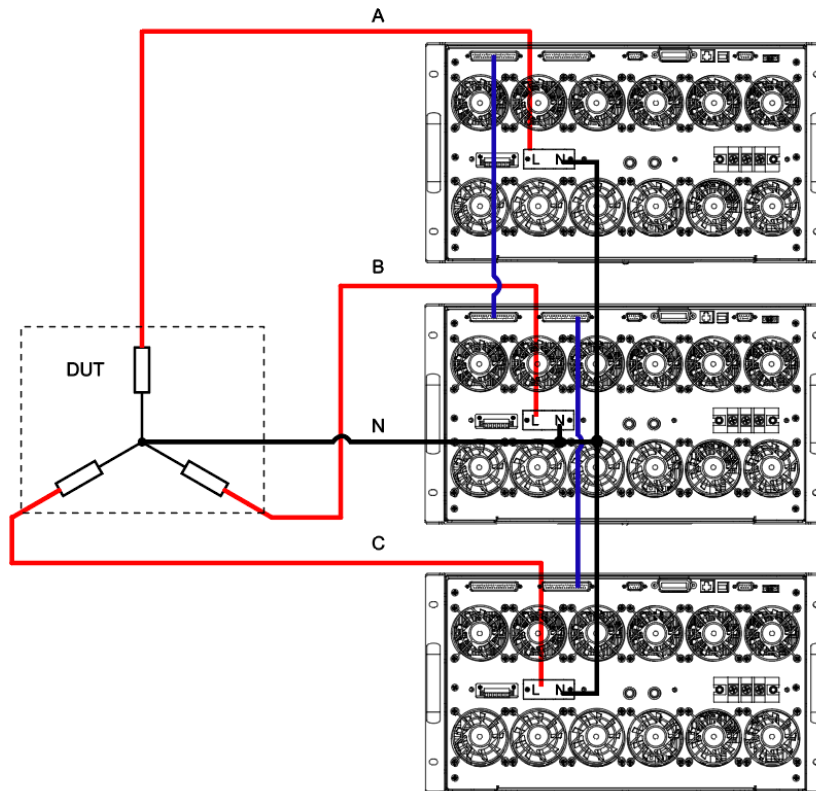

- Δ -type connection

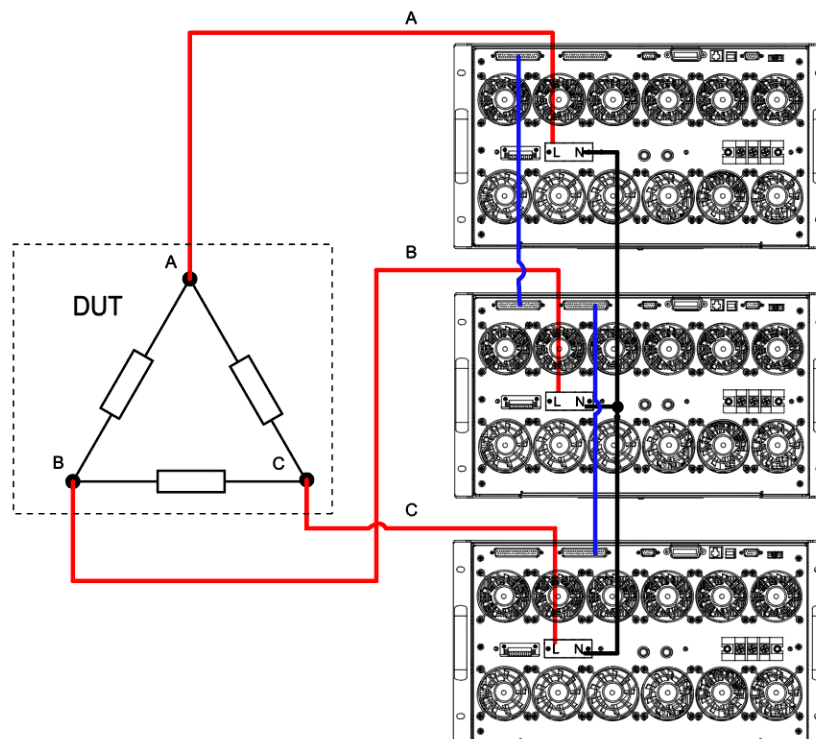

The system bus interface can be connected to multiple units via cross-over cables, as shown in the above connection diagram of three-phase parallel power supplies. Select one connection method as shown above. After wiring, configure relevant parameters of the functions of the three-phase AC power supply.

During the three-phase setting, firstly, the user must set three power supplies to be one master and two slaves. Then the user can set the phase of two slaves to B and C. The master defaults to phase A. Finally, switch the parallel mode to 3-phase mode in master. Specific setting steps are as follows.

Select two power supplies as the slaves and set the phase to B and C.

1. Press **[Shift] + [Setup]** (Menu) on the front panel to enter the main interface of the AC power supply.
2. Press **[Network Configure]** to enter the “Network Configure” interface, and set “Network Mode” to Slave. Press **[Enter]** to confirm.

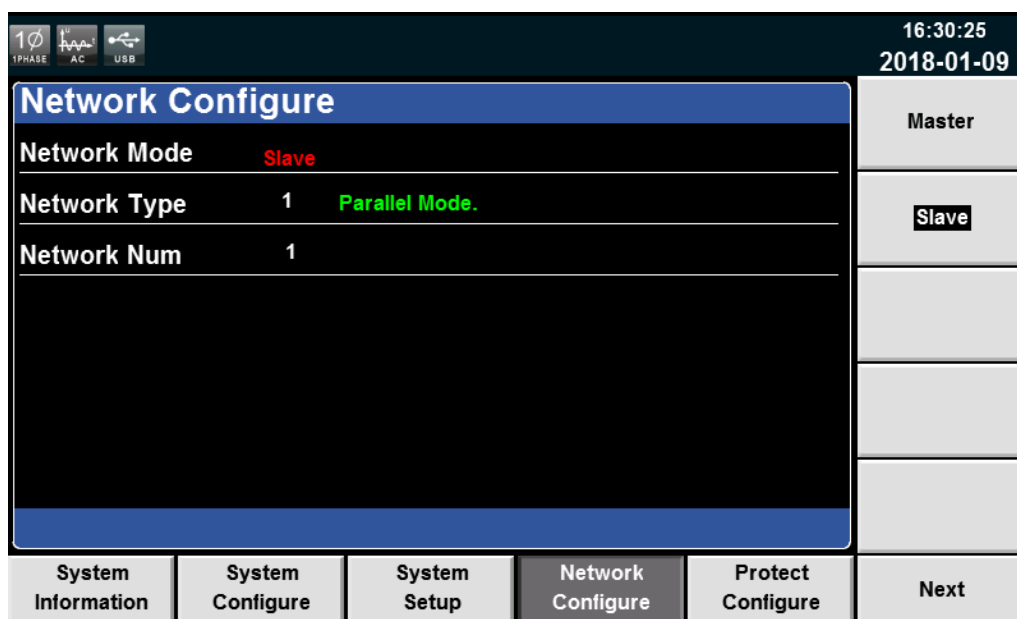

3. Press **[Esc]** to return the main interface. Power off the instrument and then power on again. (It takes about 10s to boot up the instrument.) The slave will display “SLAVE MODE! ” and the slave state is “INIT”.
4. Press soft key **[A B C]** on the slave screen to set the two slaves to B and C. Press **[Enter]** to confirm.

Select one power supply as the master.

1. Press **[Shift] + [Setup]** (Menu) on the front panel to enter the main interface of the AC power supply.
2. Press **[Network Configure]** to enter the “Network Configure” interface, and set “Network Mode” to Master. Set “Network Num” to 3. Press **[Enter]** to confirm.
3. The interface prompts “Configure Ok!”. The slave state displays “NORMAL”. This means the parallel configuration is successful.
4. Press **[Esc]** to return to the main interface. Press **[Current Mode]**.

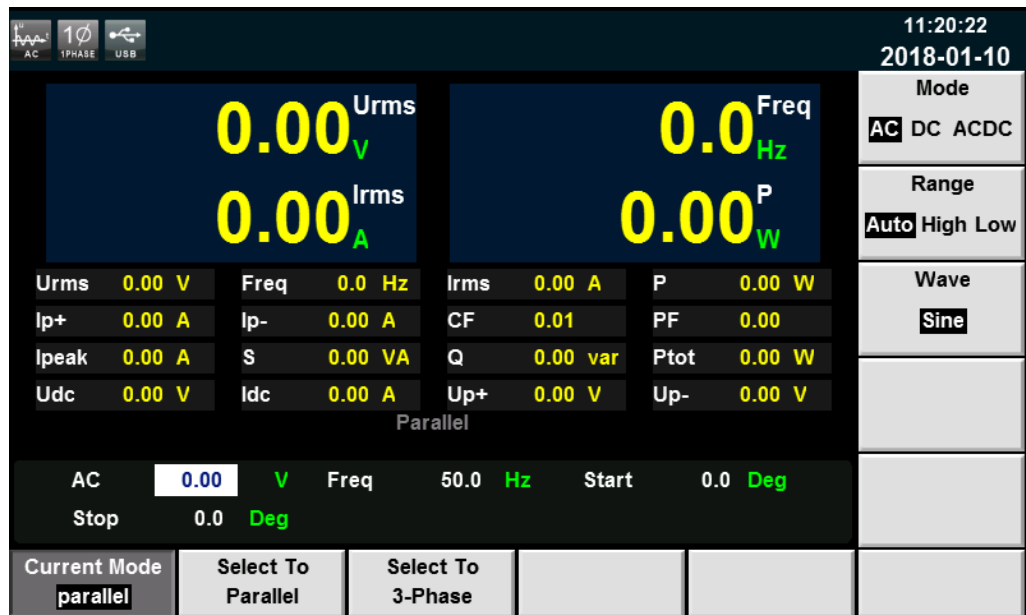

- Press **[Select To 3-Phase]** to enter the three-phase function configuration interface. Press **[Enter]** to confirm. The master interface shows as follows and the slave interface displays PHASE B and PHASE C. This means the 3-phase parallel configuration is successful.

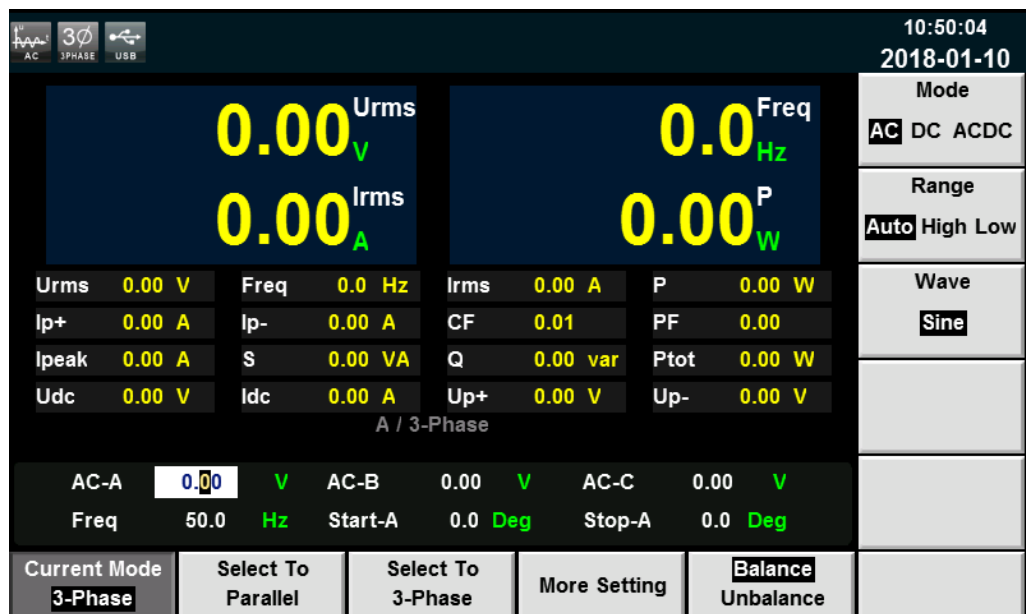

Multiple units each phase

Connect multiple power supplies (up to six units each phase) in each phase to increase the output power and current.

Take the example of two units in each phase, the schematic diagram of Y-type and Δ -type connection is shown as below.

- Y-type connection

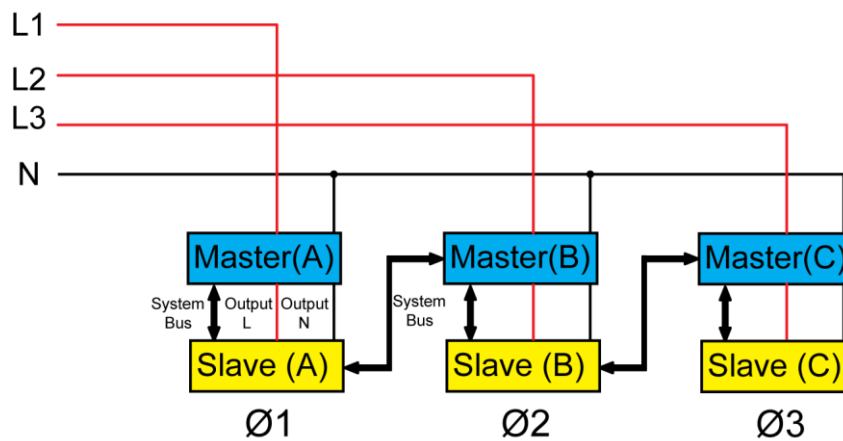

- Δ-type connection

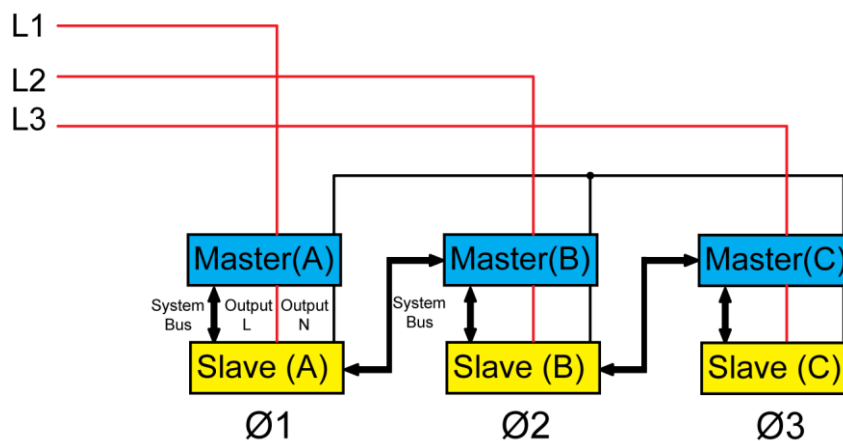

 **Note**

In the three-phase parallel mode, you need to disconnect the wires/short clips between L and SL, N and SN, and then connect the SL and SN of each power supply to DUT when you use the remote measurement function.

Select one connection method as shown above. After wiring, configure relevant parameters of the functions of the three-phase AC power supply.

During the three-phase setting, firstly, the user must set six power supplies to be one master and five slaves. Then the user can set the phase of five slaves to A, B, B, C and C. The master defaults to phase A. Finally, switch the parallel mode to 3-phase mode in master. Specific setting steps are as follows.

Select five power supplies as the slaves.

1. Press **[Shift] + [Setup]** (Menu) on the front panel to enter the main interface of the AC power supply.
2. Press **[Network Configure]** to enter the “Network Configure” interface, and set “Network Mode” to Slave. Press **[Enter]** to confirm.
3. Press **[Esc]** to return the main interface. Power off the instrument and then power on again. (It takes about 10s to boot up the instrument.) The slave will display “SLAVE MODE!” and the slave state is “INIT”.
4. Press soft key **[A B C]** on the slave screen to set the phase of five slaves to A, B, B, C and C. Press **[Enter]** to confirm.

Select one power supply as the master.

1. Press **[Shift] + [Setup]** (Menu) on the front panel to enter the main interface of the AC power supply.
2. Press **[Network Configure]** to enter the “Network Configure” interface, and set “Network Mode” to Master. Set “Network Num” to 6. Press **[Enter]** to confirm.
3. The interface prompts “Configure Ok!”. The slave state displays “NORMAL”. This means the parallel configuration is successful.
4. Press **[Esc]** to return the main interface. Press **[Current Mode]**.
5. Press **[Select To 3-Phase]** to enter the three-phase function configuration interface. Press **[Enter]** to confirm.

3.21 Three-phase mode setup

IT7600 series power supply supports single-phase or three-phase output and can achieve test applications for three-phase AC power supply.

- IT7622, IT7624 and IT7626 can achieve three-phase AC power test applications through multiple paralleling.
- IT7625, IT7627, IT7628L and IT7628 support one key to switch single / three-phase output through the panel or software.
- IT7630, IT7632, IT7634 and IT7636 support three-phase output.



Note

When IT7600 series power supplies are in three-phase control, only AC output mode is supported.

Detailed operation steps are shown below:

1. By default, the system allows to set the amplitude value of three phases under Balance mode (the three phases have same frequency and amplitude, but the phase difference is 120 degrees), as shown in the figure below.

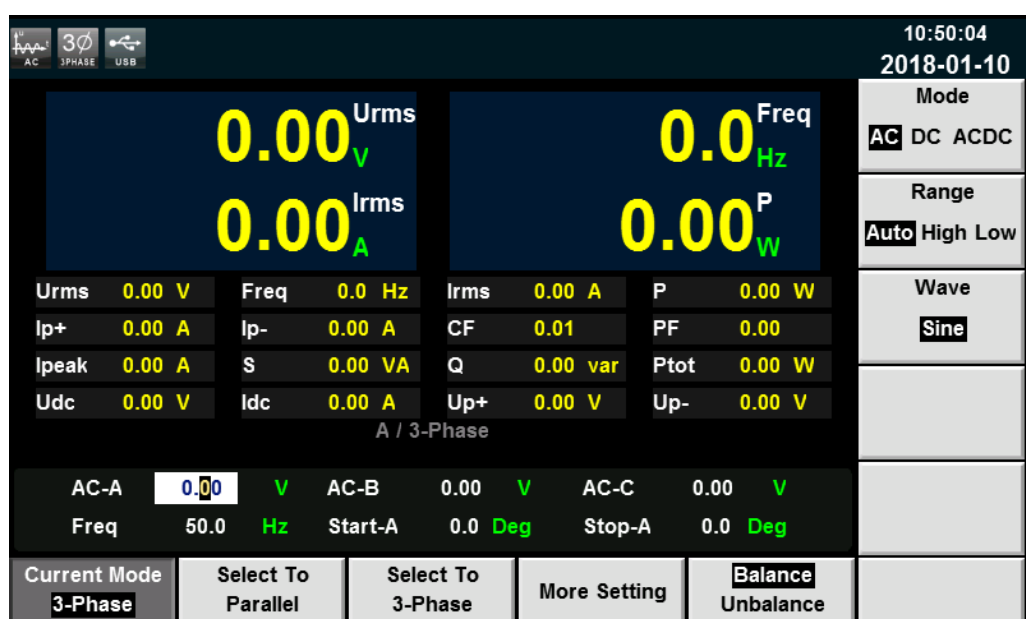

Parameter setting is as follows:

Parameter	Explain
AC-A	Set the voltage of Phase A.
AC-B	Set the voltage of Phase B.
AC-C	Set the voltage of Phase C.
Freq	Set the frequency of Phase A, B and C.
Start-A	Set the start angle.
Stop-A	Set the stop angle.

- To test the DUT under Unbalance three-phase mode, press soft key **[Unbalance]** to enter the three-phase parameter configuration interface under Unbalance mode, and set voltage values, frequency values, start angles and end angles of the three phases. Press soft key **[More Setting]** to set the angle difference of the three phases. As shown below.

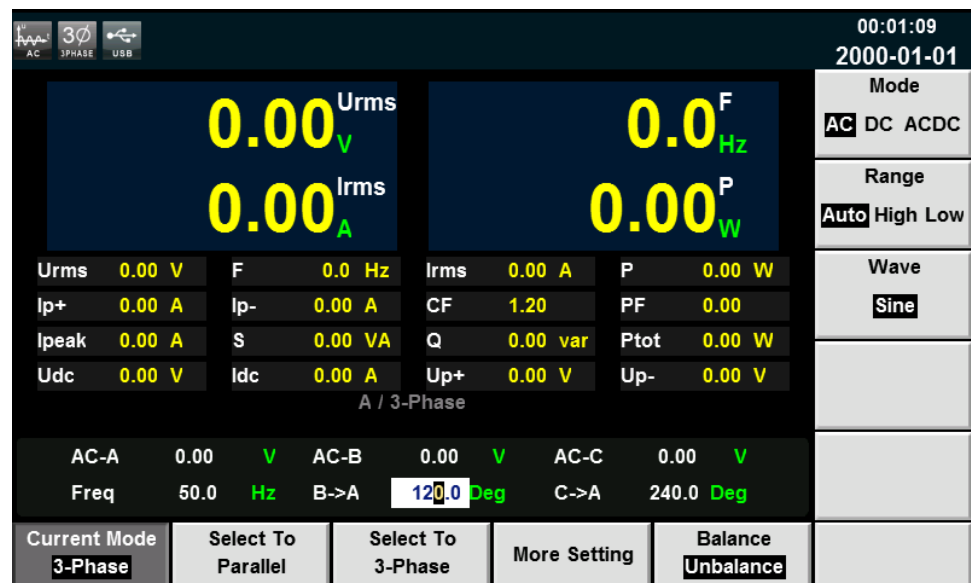

Parameter setting is as follows:

Parameter	Explain
AC-A	Set the voltage of Phase A.
AC-B	Set the voltage of Phase B.
AC-C	Set the voltage of Phase C.
Freq	Set the frequency of Phase A, B and C.
Start-A	Set the start angle.
Stop-A	Set the stop angle.
B->A	Set the angle difference between Phase B and A.
C->A	Set the angle difference between Phase C and A.

- After setting the parameters, press **[On]** on the front panel. Relevant values will be displayed on LCD.

Chapter4 Measurement Functions

This chapter describes the characteristics and operations of the basic metering function of IT7600 series source.

IT7600 series source has rich functions of basic metering of electric energy and can accurately measure the parameters such as Vrms, Irms, Ipeak, Idc, CF, PF

4.1 Interface Introduction

Press **[Meter]** on the front panel to enter the metering interface, as shown in the figure below.

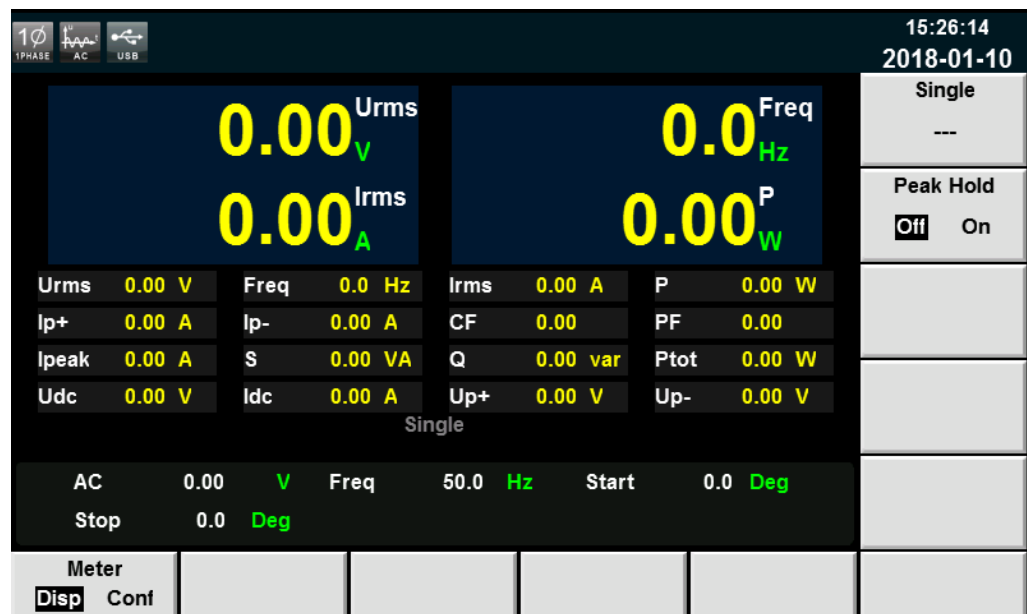

Soft Key of Menu	Description
Single	Single mode
Peak Hold	Peak Holding Mode On: to enable the peak holding mode Off: to disable the peak holding mode.
Meter	Disp: metering display interface Conf: metering parameter configuration interface

4.2 Setup interface

Press **[Meter]** on the lower part of the screen, and then press **[Conf]** to enter the metering parameter configuration interface, as shown in the figure below.

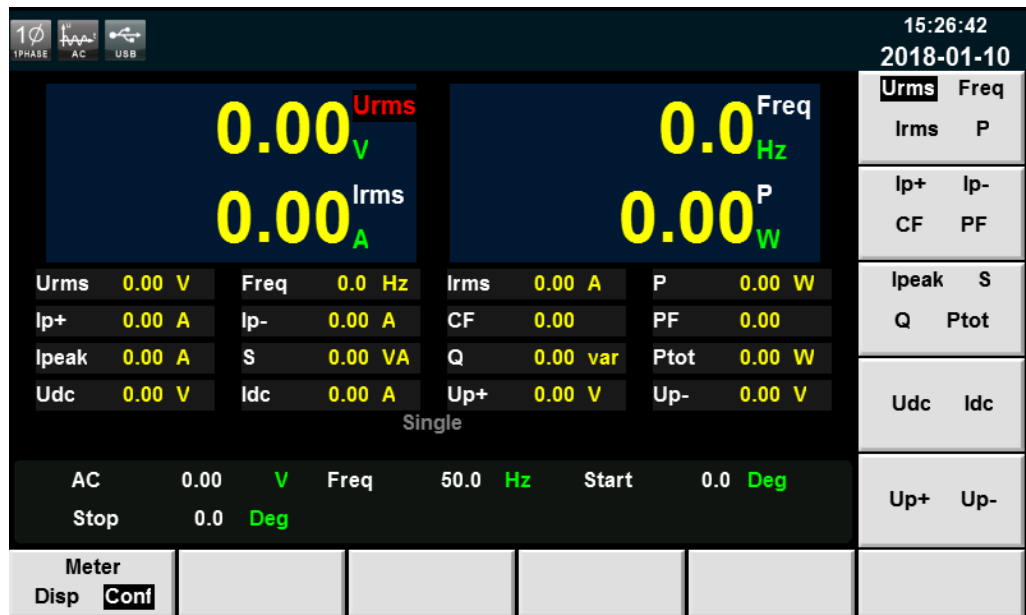

The user can self-define the screen parameters. Four large-font parameters are displayed on the upper part of the interface. The above figure shows the voltage, frequency, current and active power. Press the Up and Down keys to move the cursor, and select the parameter (red background). Press the corresponding soft key on the right side to adjust the current parameter. Set all the parameters by the above steps.

Description of the metering parameters:

Parameter	Description	Parameter	Description
U	Voltage value	F	Frequency value
I	Current value	P	Active power [W]
Ip+	Positive current peak value [A]	Ip-	Negative current peak value [A]
CF	Crest factor	PF	Power factor
Ipeak	Peak current value	S	Apparent power
Q	Reactive power	Ptot	Total power
Udc	DC voltage	Idc	DC current
Up+	Positive voltage peak value	Up-	Negative voltage peak value

Chapter5 Oscilloscope Functions

IT7600 series source has the oscilloscope function. This chapter describes the oscilloscope function and operations of the AC source.

5.1 Interface Introduction

IT7600 series source has the function of displaying the waveform based on sampling data. The user can select to display or hide the voltage and current waveform of the input unit. Only the necessary waveform is displayed, which can facilitate observation. The waveform display interface includes the vertical axis and horizontal axis.

Introduction to soft keys of interface

Press [**Scope**] on the front panel and the following waveform display interface will appear.

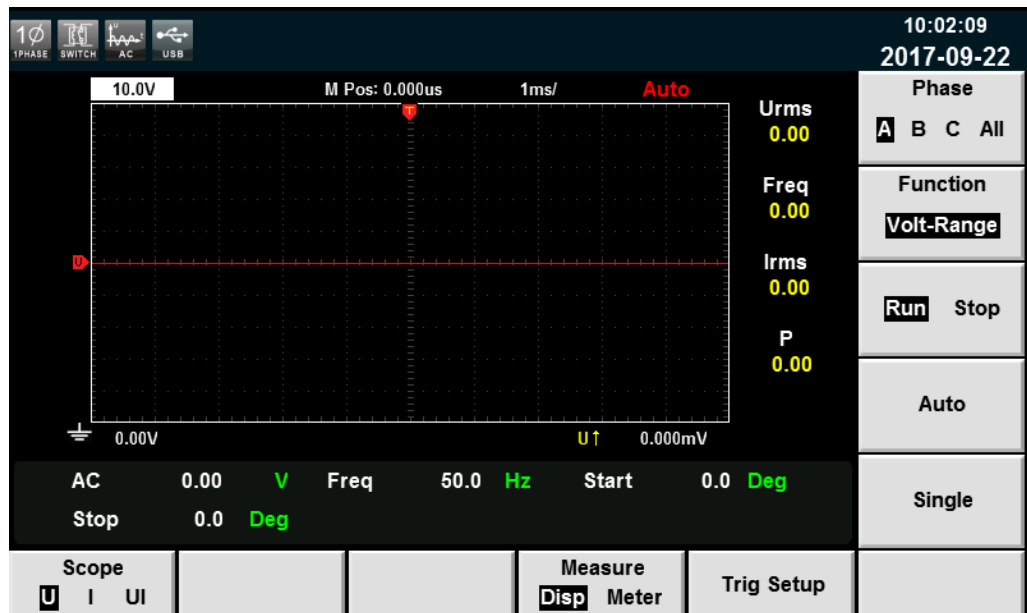

Description of keys on the waveform display interface:

Parameter Name	Description
Scope(U/I/UI)	Used for selecting the waveform to be displayed on the screen: voltage, current and voltage/current.
Measure(Disp/Meter)	Waveform display / Waveform metering value display
Trig Setup	Trigger setting.
Phase	Phase selection, with four options: A, B, C and ALL. The default is Phase A in the standalone mode. You can switch the four options under three-phase mode.

Parameter Name	Description
Function	Knob selection: the following variables can be adjusted by rotating the knob <ul style="list-style-type: none"> ● Volt-Range: voltage range ● Curr-Range: current range ● Volt-Base: voltage base ● Curr -Base: current base ● Trig-Level: trigger level ● Trig-Delay: trigger delay ● Trig-TimeBase: TimeBase
Run/Stop	Run/stop: press the corresponding soft key to run or stop the waveform status.
Auto	Automatic adjustment key: when the corresponding soft key is pressed, the input signal of the power meter will be calibrated automatically to display the best effects of input signals.
Single	Single measurement key: when single measurement is enabled in the Stop status, the stop status is enabled again after one measurement based on the current data updating rate. When single measurement is enabled in the Run status, the instrument immediately restarts one measurement and then enters the Stop status.

Introduction to waveform display interface

Voltage grid Trigger delay Time grid Trigger state

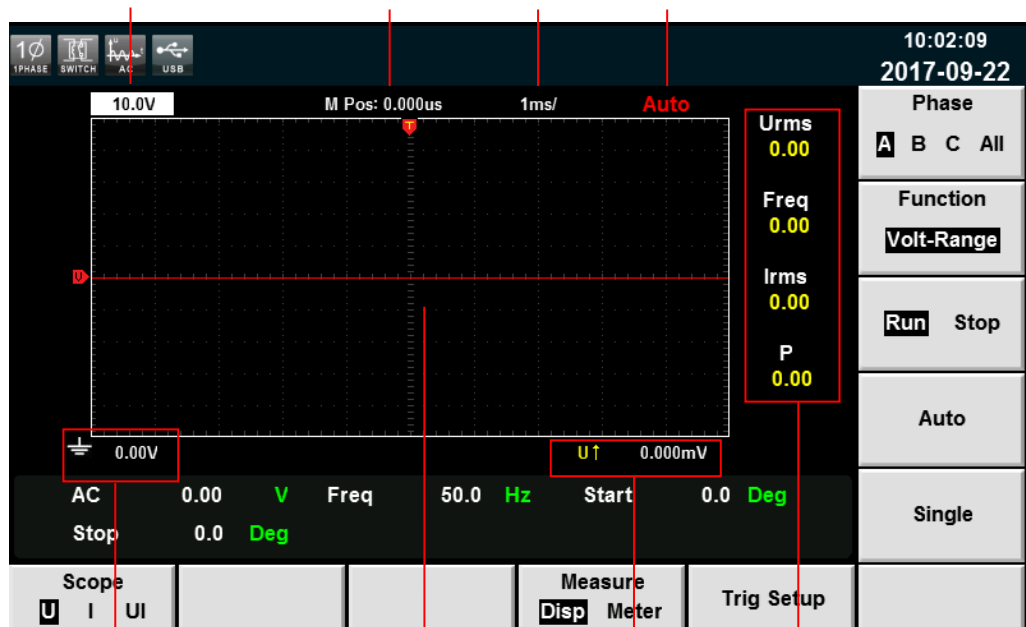

The voltage difference between ground level and point of center vertical

Wave

Trigger level

Measuring parameters

Description of the trigger state:

Trigger State	Description
Auto	The selected trigger mode is "Auto". After triggering, the trigger state "Auto" appears.
Auto?	The selected trigger mode is "Auto". The trigger state is "Auto?" if triggering is not performed.
Trig	The selected trigger mode is "Normal". After triggering, the trigger state "Trig" appears.
Trig?	The selected trigger mode is "Normal". The trigger state is "Trig?" if triggering is not performed.
Stop	Press the soft key [Stop] in the waveform display interface. The trigger state "Stop" appears.

Vertical calibration

The voltage range and current range are subject to vertical calibration (voltage/scale and current/scale). Press the soft key **[Function]** and select Volt-Range or Curr-Range. Rotate the knob to set the voltage or current range of each interval.

Horizontal calibration

If the soft key **[Function]** is pressed and "Trig-TimeBase" is selected, you can rotate the knob to adjust the horizontal scale (scanning speed). When the horizontal (time/scale) setting is changed by rotating the knob, you can observe the change of time/scale on the screen. During data collection, the sampling speed can be changed by adjusting the horizontal calibration knob. After collection is stopped, the collected data can be amplified by adjusting the horizontal calibration knob.

Trigger delay

If the soft key **[Function]** is pressed and "Trig-Delay" is selected, you can rotate the knob to adjust the trigger delay. In this case, if the knob is rotated, the trigger point will move horizontally and the delay time will be displayed on the screen. To change the delay time, move the trigger point () horizontally and set the distance between the trigger point and the horizontal center. The trigger point moves along the top end of the display grid.

Trigger waveform

When the specified trigger conditions are satisfied, the trigger waveform will be displayed. The triggering time is the trigger point, generally on the right of the screen. When the trigger point is reached, the screen will display the waveform from left to right over time. The user should set the following parameters before using the trigger function.

- Trigger mode

The trigger mode refers to the condition to update the contents on the screen. It is divided into the Auto mode and Normal mode. In the Auto mode, the displayed waveform will be updated when triggering occurs in the suspension time; otherwise, the displayed waveform will be updated automatically.

In the Normal mode, the displayed waveform will be updated in the case of triggering and not updated in the case of no triggering.

- Trigger source

The trigger source is used for generating trigger conditions. The user can select the trigger source in the input signal of the input unit.

- Trigger slope

The slope refers to the change of the signal from low level to high level (rising edge) or from high level to low level (falling edge). The slope used as a trigger condition is referred to as the trigger slope.

- Trigger level

The trigger level refers to the level which the trigger slope passes through. If the signal of the trigger source passes through the set trigger level according to the specified trigger slope, triggering occurs. When the soft key **[Function]** is pressed and “Trig-Level” is selected, you can rotate the knob to adjust the trigger level. In this case, the trigger level can be changed by rotating the knob and you can observe trigger level changes on the screen.

5.2 Adjustment of measuring parameters

The user can adjust the four measuring parameters according to the test requirement. The detailed operation steps are as follows:

Operation steps

1. Press **[Scope]** to enter into the scope interface.
2. Press **[Measure]** and select **[Meter]**.

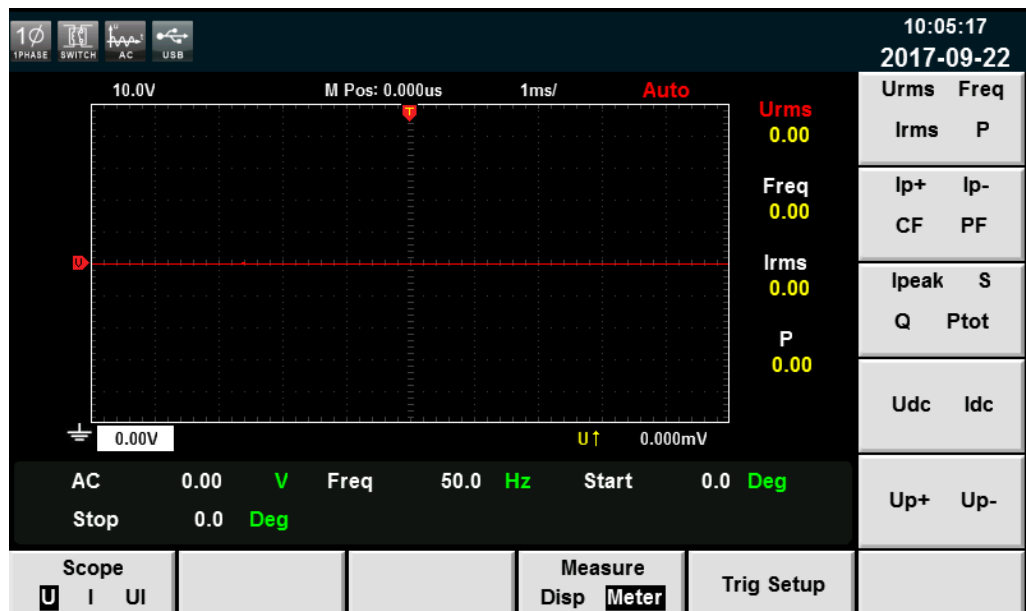

3. Press soft keys on the front panel to select the measuring parameters you need.

5.3 Setting of Trigger Configuration

To enable the trigger function, you should select the trigger source, trigger mode, trigger slope, etc. Detailed steps are as follows.

Operating steps

1. Press **[Scope]** to enter the waveform display interface.
2. Press the soft key “**Trig Setup**”, shown as below.

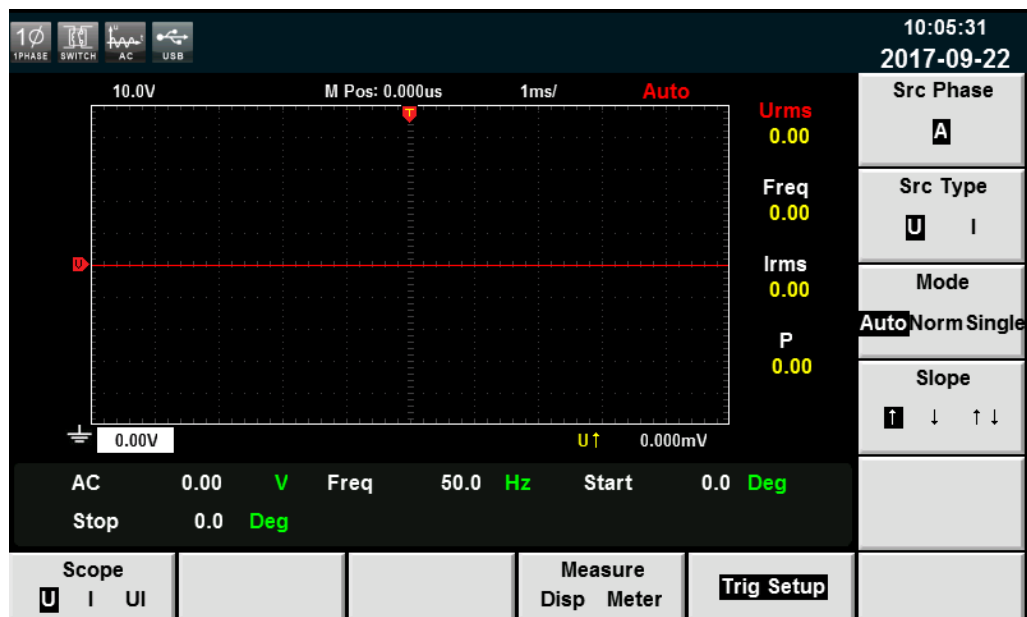

3. Press the soft key corresponding to the parameter on the right side and select the required trigger configuration.

Parameter descriptions:

Parameter	Explain
Src Phase	Trigger phase.
Src Type	Trigger type: select the voltage or current as the trigger type.
Mode	Trigger mode: select the Auto, Normal or single mode.
Slope	Trigger slope: select the rising edge, falling edge or rising/falling.

Chapter6 Harmonic Function

This chapter describes the characteristics and operations of the voltage harmonic measurement function of IT7600 series source.

The bandwidth of IT7600 series AC source is 5kHz. The voltage/current harmonic measurement of high speed and wide dynamic scope can be realized. In the harmonic mode, phase and voltage/current harmonic distortion factor (UTHD) can be tested. In addition, IT7600 can be used for measuring multiple harmonics. In addition, multiple harmonic measurements under different frequency bands can be realized in IT7600. For example, 50 times under 500Hz; 20 times at 500Hz to 2000Hz; and 10 times above 2000Hz.

6.1 Interface Introduction

IT7600 series source can display harmonic parameters in the list or bar chart form to make the analysis of test result clear.

Introduction to soft keys of interface

Press **[Harmonic]** on the front panel and the following initial interface of harmonic measurement will appear.

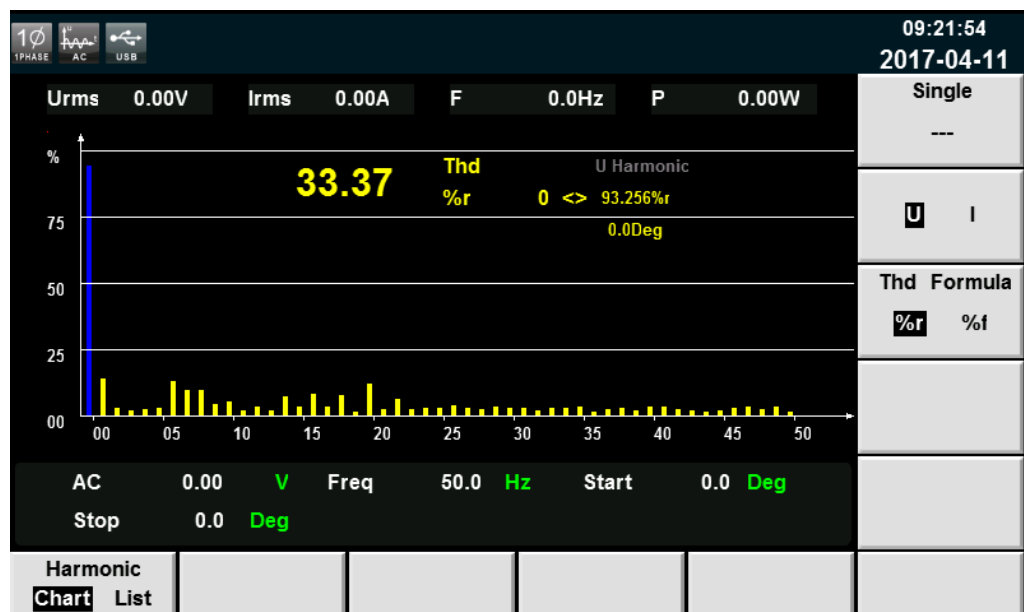

Description of the harmonic measurement interface:

Parameter Name	Parameter Description
Chart	Displayed in the bar chart form
List	Displayed in the list form
Single	Single mode
U/I	Select the voltage/current harmonic
Thd Formula	Distortion factor calculation formula. <ul style="list-style-type: none"> ● %r: displaying harmonics in the form of percentage to the overall voltage amplitude of all harmonics. ● %f: displaying harmonics in the form of percentage to the fundamental voltage.

Introduction to harmonic display interface

- Harmonic bar chart screen

When “Chart” is selected in the harmonic measurement screen, the bar chart of harmonic measurement results will be displayed. The bar chart is used to show the percentage of each harmonic measurement.

Percentage of harmonic

Parameter of harmonic

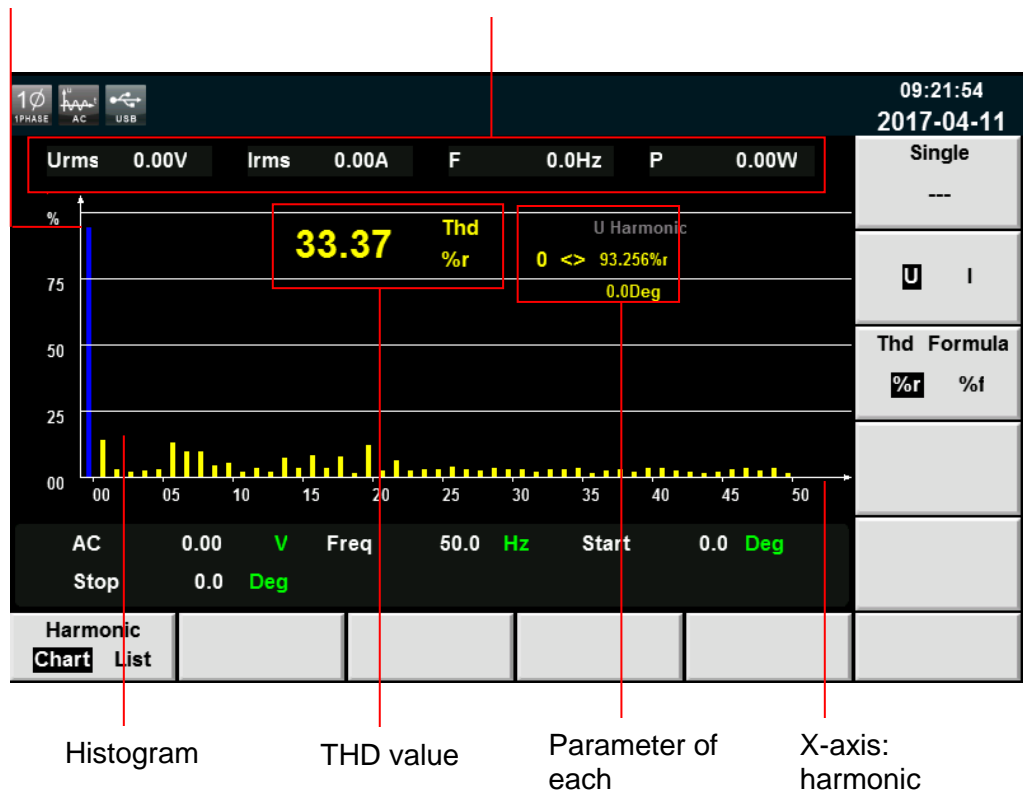

Total harmonic parameters: Under single phase mode, display total harmonic distortion of the single phase. Under three-phase mode, display total harmonic distortion (THD) factors corresponding to Phase A, B and C.

Single harmonic parameters: Under single phase mode, display single harmonic distortion factor and phase of the single phase. Under three-phase mode, display the single harmonic distortion factor and corresponding phase. The phases A, B and C are respectively in yellow, green and red. The user can rotate the knob to select each harmonic to be displayed. The selected harmonic will be displayed in blue in the bar chart.

- Harmonic list

When “LIST” is selected in the harmonic measurement mode, the list of harmonic measurement results will be displayed, when “U” is selected, the list will display the voltage and phase values under various harmonics. When “I” is selected, the current and phase values will be displayed. Under single-phase mode, the list only displays measurement results for Phase A, and displays 0 for the other two phases, as shown in the figure below; under three-phase mode, display effective values for the three phases.

1 ϕ AC USB

09:23:02
 2017-04-11

Urms 0.00V
Irms 0.00A
F 0.0Hz
P 0.00W

Order	Ua(%r)	PhaseA(#)	Ub(%r)	PhaseB(#)	Uc(%r)	PhaseC(#)
0	95.234	0.0	0.000	0.0	0.000	0.0
1	14.317	0.0	0.000	0.0	0.000	0.0
2	1.475	-170.4	0.000	0.0	0.000	0.0
3	3.734	-36.7	0.000	0.0	0.000	0.0
4	3.169	-59.1	0.000	0.0	0.000	0.0
5	3.049	-166.3	0.000	0.0	0.000	0.0
6	6.806	-173.0	0.000	0.0	0.000	0.0
7	3.144	-164.9	0.000	0.0	0.000	0.0
8	3.313	-173.4	0.000	0.0	0.000	0.0
9	3.510	-7.2	0.000	0.0	0.000	0.0

AC 0.00 V Freq 50.0 Hz Start 0.0 Deg
 Stop 0.0 Deg

Harmonic Chart **List**

Single

 U I
 Thd Formula
 %r %f

1 ϕ AC USB

09:23:21
 2017-04-11

Urms 0.00V
Irms 0.00A
F 0.0Hz
P 0.00W

Order	Ia(%r)	PhaseA(#)	Ib(%r)	PhaseB(#)	Ic(%r)	PhaseC(#)
0	96.661	0.0	0.000	0.0	0.000	0.0
1	3.629	0.0	0.000	0.0	0.000	0.0
2	5.092	-66.8	0.000	0.0	0.000	0.0
3	3.818	-46.5	0.000	0.0	0.000	0.0
4	4.848	-109.0	0.000	0.0	0.000	0.0
5	3.666	-88.8	0.000	0.0	0.000	0.0
6	3.564	-115.3	0.000	0.0	0.000	0.0
7	2.163	5.2	0.000	0.0	0.000	0.0
8	2.480	-130.5	0.000	0.0	0.000	0.0
9	3.292	-9.6	0.000	0.0	0.000	0.0

AC 0.00 V Freq 50.0 Hz Start 0.0 Deg
 Stop 0.0 Deg

Harmonic Chart **List**

Single

 U I
 Thd Formula
 %r %f

Measurement parameters are defined as follows:

Abbreviation	Description	Abbreviation	Description
U (%f)	Harmonic distortion factor of voltage	I (%f)	Harmonic distortion factor of current
Phase(°)	Phase	-	-

Harmonic number list: the signal data of 0-50th harmonic(s) will be shown in the LIST. You can press the Up and Down key to display the hidden rows, i.e. hidden data of single harmonic data.

6.2 Distortion factor calculation formula

The following two formulas can be selected for calculation of the distortion

factor.

- %r: use all harmonic measurement data from the minimum harmonic order (0th) to the maximum harmonic order (within the upper limit of analysis orders) as the denominator.
- %f: using the data of fundamental wave (1-order) components as the denominator.

The distortion factor calculation formulas and methods of different measurement functions are as follows:

Measurement function	Calculation formula and method	
	%r	%f
Harmonic distortion factor of voltage	$\frac{U(k)}{U(Total)}$	$\frac{U(k)}{U(1)}$
Harmonic distortion factor of current	$\frac{I(k)}{I(Total)}$	$\frac{I(k)}{I(1)}$
Total harmonic distortion rate of voltage	$\frac{\sqrt{\sum_{k=2}^{max} U(k)^2}}{U(Total)}$	$\frac{\sqrt{\sum_{k=2}^{max} U(k)^2}}{U(1)}$
Total harmonic distortion rate of current	$\frac{\sqrt{\sum_{k=2}^{max} I(k)^2}}{I(Total)}$	$\frac{\sqrt{\sum_{k=2}^{max} I(k)^2}}{I(1)}$



NOTE

Total harmonics are calculated as follows: $U(Total) = \sqrt{\sum_{k=0}^{max} U(k)^2}$, $I(Total) = \sqrt{\sum_{k=0}^{max} I(k)^2}$. k indicates the harmonic order, and max indicates the upper limit of analysis orders. 50 orders at most.

Chapter7 Vector Function

This chapter describes the vector function features and operating steps of IT7600 series power supply in the three-phase mode. Only for three phase mode.

Introduction to soft keys of interface

Press **[Vector]** on the front panel to enter the vector measurement interface, as shown in the figure below.

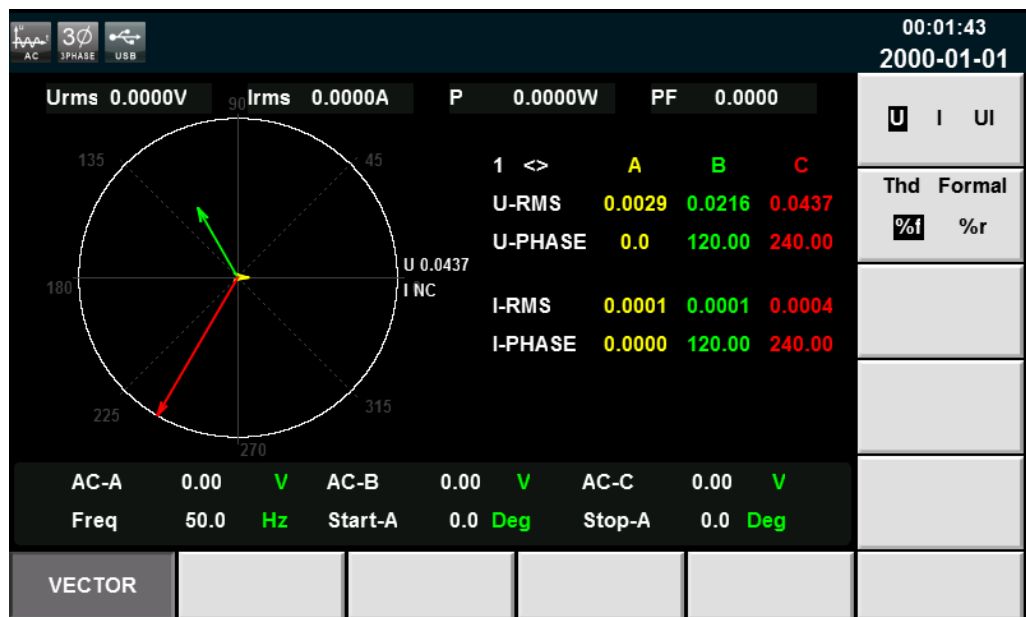

Soft Key of Menu	Description
U/I/UI	Used for selecting the waveform to be displayed on the screen: voltage, current and voltage/current.
Thd Formula	Distortion factor calculation formula. % r: displaying harmonics in the form of percentage to the overall current (or voltage power) amplitude of all harmonics. % f: displaying harmonics in the form of percentage to the fundamental current (or voltage power).

Introduction to vector display interface

Current parameter

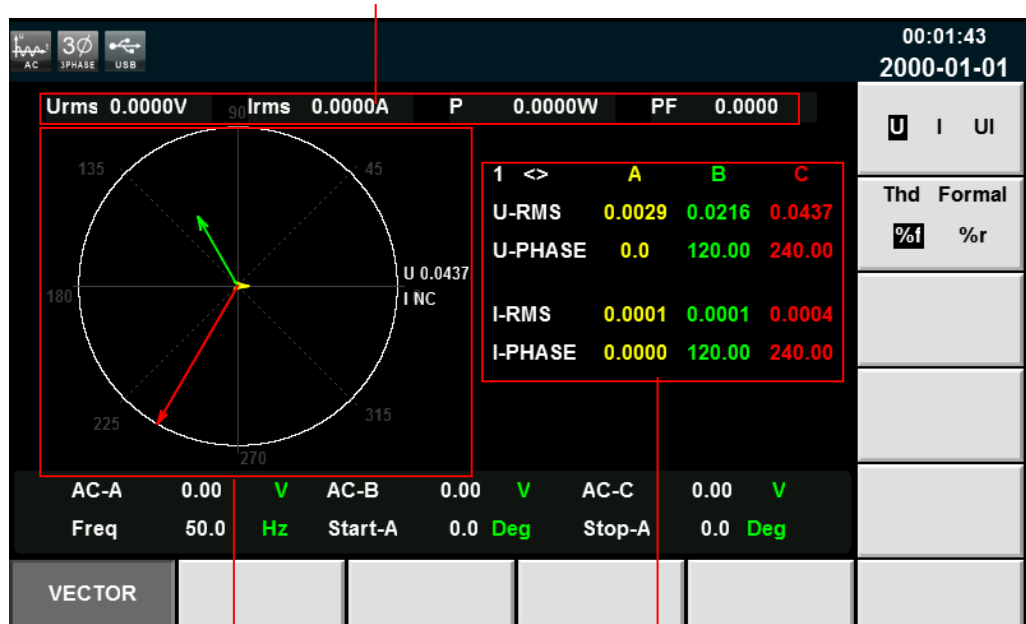

Coordinate of maximum

Vector value of single harmonic phase

Coordinate of maximum value: display the maximum U, I or UI values of the phases A, B and C.

Vector value of single harmonic phase: display the single harmonic component and phase value of each phase. The phases A, B and C are respectively in yellow, green and red. The user can rotate the knob to select the desired single harmonics.

NOTE

- The vector function is valid only in the three-phase mode.
- The phase parameters in the figure correspond to those in the harmonic function. The vector diagram is another kind of demonstration of parameters in the harmonic function.

Chapter8 Configuration of Any Waveform

This chapter will introduce configuration of any waveform of IT7600. Besides the five standard waveforms (see 3.6 Waveform Selection) built in the main interface, the user can enable the outputting of AC wave sequences of different amplitudes through List and self-define function.

8.1 List Function

Under IT7600 List mode, at maximum of 50 steps can be edited for each List file. The user can choose any waveform from existing 11 waveforms. Or, the user can choose a waveform file stored in the device through self-define function (see 8.3 “Self-defined Waveform Function” for details) and combine the waveform files into a List file based on required order. Meanwhile, the user can set the starting steps of the List file, run count and end state of the waveform, and edit parameters such as frequency, amplitude, running time and rising slope of each waveform.

8.1.1 Create a new List file

Create a new single-phase List file

Under single-phase mode, the user can output AC waveform sequences with different amplitudes by creating a new List file. Detailed operation steps are as below:

1. Press **[List]** on the front panel to enter the List function configuration interface, select soft key **[standard]**, as shown in the figure below.

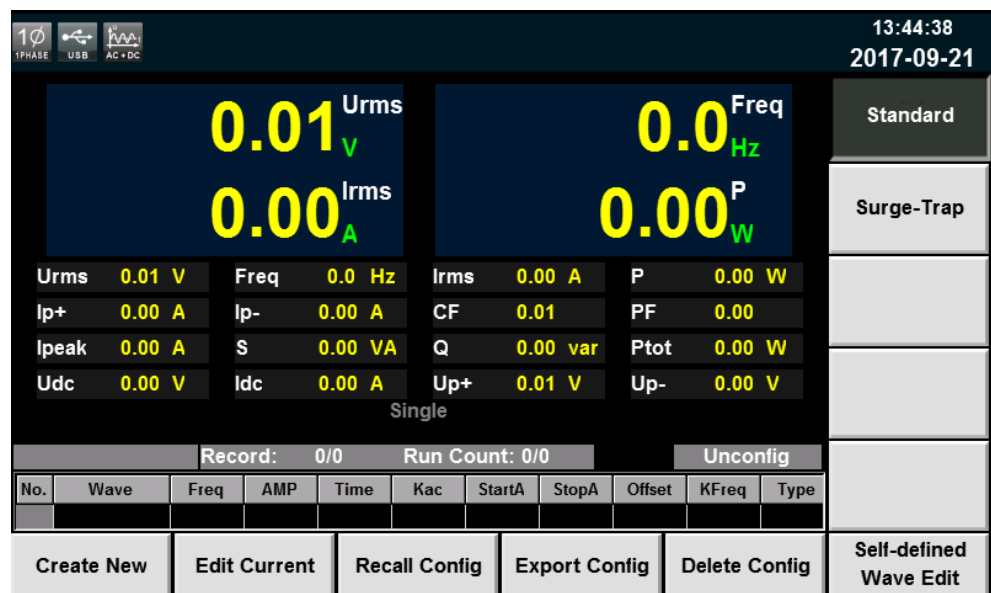

Soft Key of Menu	Description
Create New	Create a new List file.
Edit Current	Edit the saved List file.
Recall Config	Recall the saved List file.
Export Config	Export list file.
Delete Config	Delete list file.
Self-defined Wave Edit	Edit the self-defined waveform. Refer to 8.3

	“Self-defined Waveform Function” for details.
Standard	Standard list.
Surge-Trap	Surge/trapped wave. Refer to 8.2 “Setting of Surge/trapped Configuration” for details.

- Press **[Create New]** to enter the List file configuration interface.

List display zone

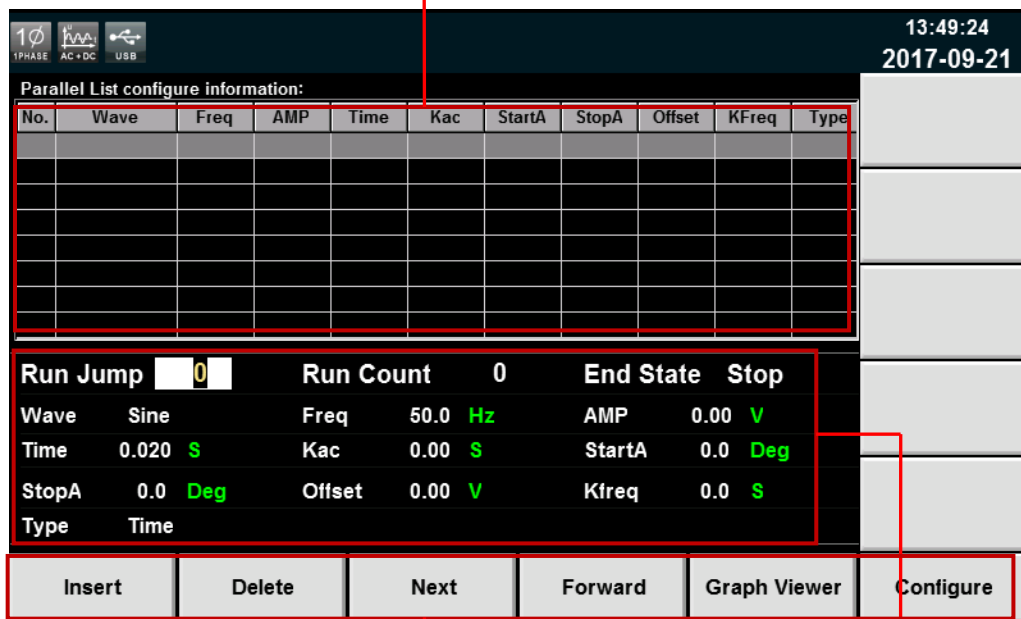

Soft buttons

List editing zone

Description of List display zone:

Mainly display the edited List. View the list by pressing **[Next]** and **[Forward]**.

Description of soft buttons on the List interface:

Parameter	Explain
Insert	Press it to insert a single step behind the current single step.
Delete	Press it to delete the current single step.
Next	Press it to select next single step.
Forward	Press it to select the previous step.
Graph Viewer	Display the waveform.
Configure	Download configuration parameters.

- Press the Up/Down key to select each parameter in the List edit zone. Besides, the user can set the starting step, run count, end state of the waveform, waveform type, frequency and amplitude by operating the number keys and soft keys.

Parameters of the List editing zone are as follows:

Parameter	Explain
Run Jump	Edit the starting steps of the List file in the loop.
Run Count	Edit the cycles of the List file. 0 represents the infinite loop.

End State	Set the final waveform, with the following options available: <ul style="list-style-type: none"> ● Stop: directly stop the waveform output after operation. ● Last: keep the last waveform output unchanged after operation.
Wave	Set the output waveform, with the following options available: <ul style="list-style-type: none"> ● Sin: sine wave ● Squire: square wave ● Triangle: triangle wave ● Exp: exponential wave ● Ramp_rise: rising slope wave ● Ramp_fall: falling slope wave ● Sin_Pos: positive sine half-wave ● Sin_Neg: negative sine half-wave ● THDWave: THD wave ● 2nd_Step: 2nd-order step function waveform ● 2nd_impulse: 2nd-order impulse function waveform You can also set the output waveform which is created by Self-defined Waveform Function
Freq	Set the frequency
AM	Set the waveform amplitude.
Time	Set the time. It ranges from 0 to 99999s. If the rate of frequency change is not zero, the time will be the lasting time after the frequency is stable.
Kac	Set the rising slope of the AC power supply. The default setup of the first step is 0V.
StartA	Set the start angle.
StopA	Set the stop angle.
Offset	Set the offset. It can't be set under three-phase mode.
Kfreq	Set the rate of frequency change between each step. The default setup of the list first step is 0V and not changeable. Setting the Kfreq to 0 means turning the frequency gradient function off. Setting the Kfreq to other values means turning the frequency gradient function on. The rate of frequency change ranges from 5Hz/s to 150KHz/s. It can't be set under three-phase mode.
Type	Control the triggering of List file, with the following options available: <ul style="list-style-type: none"> ● TIME: run next step after the set Time. ● TRIG: run next step after receiving the trigger signal. And the pin4 of the DB-9 simulation interface will output a high pulse signal.

4. Press **[Insert]** to insert a single step. The single step will automatically appear in the List. After configuration, the following interface will appear.

1 PHASE USB AC+DC

14:39:40
2017-09-21

Parallel List configure information:										
No.	Wave	Freq	AMP	Time	Kac	StartA	StopA	Offset	KFreq	Type
0	Sine	50.0	50.00	0.100	0.000	50.0	120.0	5.00	0.00	Time
1	Square	100.0	100.00	0.200	5.000	130.0	240.0	10.00	5.00	Time
2	Triangle	200.0	200.00	0.300	6.000	240.0	360.0	5.00	6.00	Time

Run Jump 0 **Run Count** 0 **End State** Stop

Time

Wave	Triangle	Freq	200.0 Hz	AMP	200.00 V
Time	0.300 S	Kac	6.00 S	StartA	240.0 Deg
StopA	360.0 Deg	Offset	5.00 V	Kfreq	6.0 S
Type	Time				

Insert
Delete
Next
Forward
Graph Viewer
Configure

5. Press **[Graph Viewer]** to draw the waveform according to the configured parameters, as shown in the figure below.

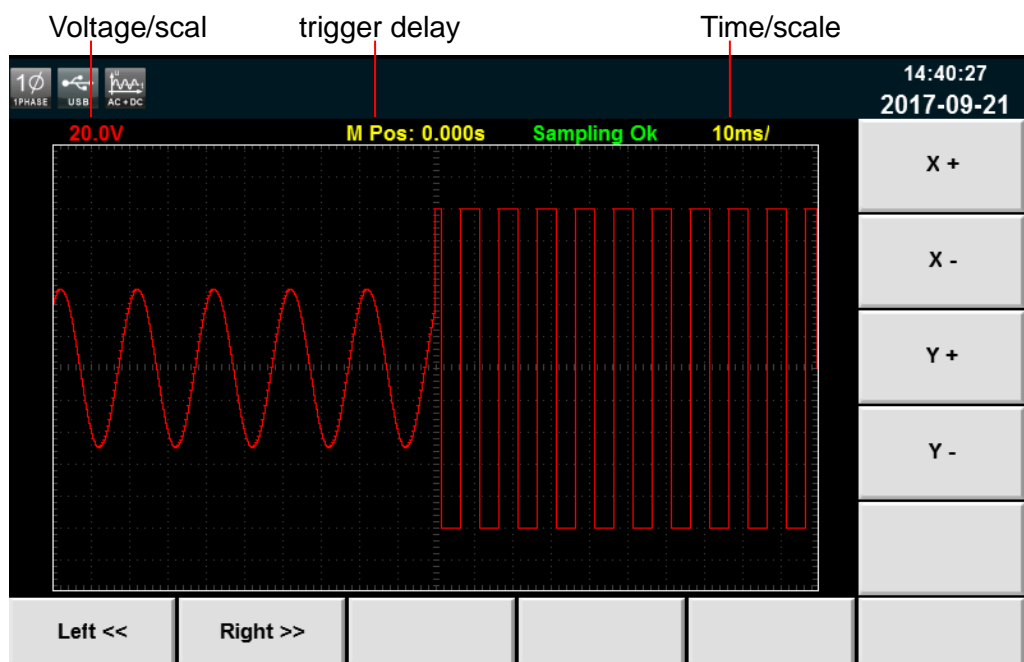

X+/ X-: Increase/decrease the time grid.

Y+/ Y-: Increase/decrease the voltage grid.

Left<</ Right>>: If the waveforms cannot be completely displayed in the present screen, move the waveform leftward/rightward or operate the knob at the front panel.

6. After editing, Press **[Esc]** to go back to the previous interface, press **[Shift] + [Recall]** (Save) on the front panel to save the file in the name "List01" (example). Press **[Enter]** to confirm.



NOTE

The filename is edited by numerical key "0", Rotary knob and Left/Right arrow keys.

- Press numerical key "0" to add one character.
 - Rotate the Rotary knob and select the needed character, including "A to Z", "a to z" and "0 to 9".
 - Press Left/Right arrow keys to move cursor position.
7. Press **[Esc]** to go back to the previous interface. The configured "List01.csv" file will appear in the interface, as shown by the red box below.

No.	Wave	Freq	AMP	Time	Kac	StartA	StopA	Offset	KFreq	Type
0	Sine	50.0	50.0	0.100000	0.000	50.0	120.0	5.00	0.00	Time

Create a new three-phase List file

List parameter configuration under the three-phase mode differs from that under the single-phase mode. Other operating steps remain the same. List parameter configuration interface under the three-phase mode is shown in the figure below. The user can set a series of parameters such as waveform and frequency of each step in the List interface. Press soft key **[Insert]** and the system defaults to insert this single step under the three-phase balance mode. The three-phase parameters remain consistent.

No.	Wave	Freq	AMP	Time	Kac	StartA	StopA	Offset	KFreq	Type
0	Sine	50.0	20.00	0.020	0.000	80.0	90.0	0.00	0.00	Time
1	Triangle	200.0	250.00	0.060	4.000	90.0	150.0	0.00	0.00	Time
2	Square	250.0	300.00	0.080	6.000	150.0	210.0	0.00	0.00	Time

Run Jump: 0 Run Count: 0 End State: Stop

Wave: Sine Freq: 50.0 Hz AMP: 20.00 V

Time: 0.020 S Kac: 0.00 S StartA: 80.0 Deg

StopA: 90.0 Deg Offset: 000.00 V Kfreq: 0000.0 S

Type: Time

To set parameters of each phase, click **[More]** to appear a detailed interface of List single-step parameter configuration under the three-phase mode. The user can complete all configurations of the three-phase parameters, as shown in the figure below. After configuring, go back to the List interface. Parameters with inconsistent three-phase are marked with a “*” at front, as shown in the red box above. The list only displays A-phase parameters.

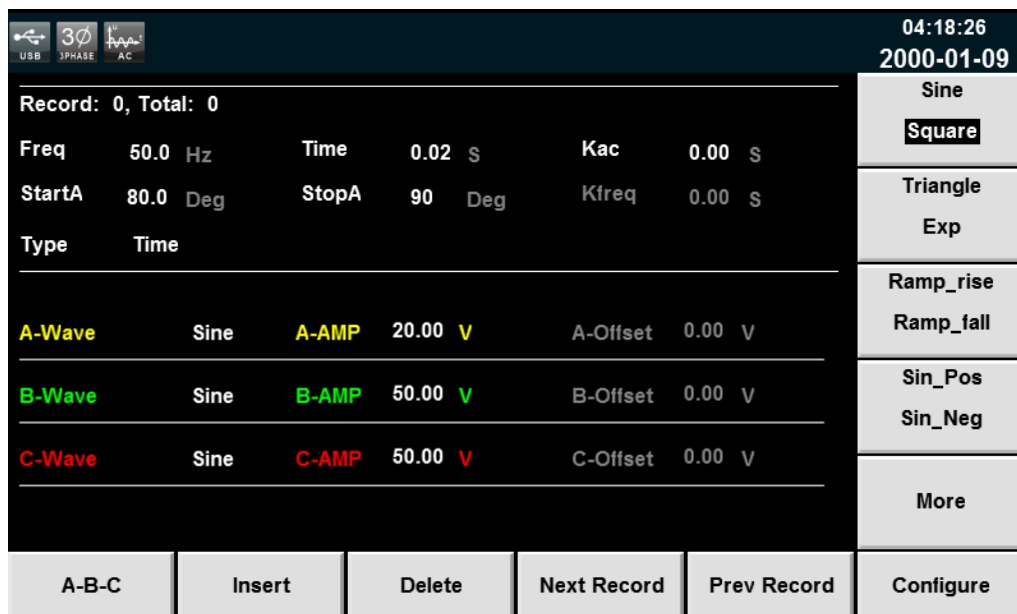

Description of soft keys under three-phase mode:

Parameter	Explain
A-B-C	Switch A/B/C phase to set the parameters quickly.
Insert	Press it to insert a single step behind the current single step.
Delete	Press it to delete the current single step.
Next Record	Press it to select next single step.
Pre Record	Press it to select the previous step.
Configure	Download configuration parameters.

8.1.2 Edit List file

The user can re-modify the list file stored in the device based on the requirement. The detailed operation steps are as follows:

1. Press **[List]** on the front panel to enter the List function configuration interface, select soft key **[standard]**.
2. Press **[Edit Current]** to enter the saved List01 csv file.
3. Edit the saved List02 csv file, as shown in the figure below.

Parallel List configure information:											Time
No.	Wave	Freq	AMP	Time	Kac	StartA	StopA	Offset	KFreq	Type	Trig
0	Sine	50.0	50.00	0.100	0.000	50.0	120.0	5.00	0.00	Time	
1	Square	100.0	100.00	0.200	5.000	130.0	240.0	10.00	5.00	Time	
2	Triangle	200.0	200.00	0.300	6.000	240.0	360.0	5.00	6.00	Time	
Run Jump 0 Run Count 0 End State Stop Wave Triangle Freq 200.0 Hz AMP 200.0 V Time 0.300 S Kac 6.00 S StartA 240.0 Deg StopA 360.0 Deg Offset 5.00 V Kfreq 6.0 S Type Time											
Insert		Delete		Next		Forward		Graph Viewer		Configure	

- After editing, press **[Shift] + [Recall]** (Save) to save the file.

8.1.3 Recall List file

If several List files are edited, press Recall to recall the List file to be tested. Detailed operation steps are as below:

- Press **[List]** on the front panel to enter the List function configuration interface.
- Press **[Recall Config]**, select the saved List01 csv file, and press **[Enter]** to enter the file.

8.1.4 Import/Export List file

Import List file

IT7600 series support import function of list files. The user can finish the editing of List file in Excel and import it into the software. This function simplifies the List file edit and facilitates user operation. Detailed operation steps are as below:

- Create a new Excel document on local PC and name it List02.
- Open the Excel document and save it as in "other formats" i.e. (*.csv).
- Open the List02.csv document and edit the List. Set every step of the List and corresponding parameters and save the document in the USB disk.

List import file formats under single-phase mode:

List total steps Single-phase

	A	B	C	D	E	F	G	H	I	J	K
1	list	3	0								
2	jump	count	end-state								
3	0	0	0								
4	NO.	Wave	Freq	AM	Time	Kac	StartA	StopA	Offset	KFreq	Type
5	0	0	50	50	0.02	0	30	90	2	0	0
6	1	1	100	150	0.05	2	90	150	4	2	0
7	2	2	150	200	0.08	4	150	210	6	4	0

List import file formats under three-phase mode: (The three same No. values correspond to A/B/C phase parameters of this step).

List total steps Three-phase

	A	B	C	D	E	F	G	H	I	J	K
1	list	3	2								
2	jump	count	end-state								
3	0	0	0								
4	NO.	Wave	Freq	AM	Time	Kac	StartA	StopA	Offset	KFreq	Type
5	0	0	50	50	0.02	0	30	90	0	0	0
6	0	0	50	50	0.02	0	270	0	0	0	1
7	0	0	50	50	0.02	0	150	0	0	0	1
8	1	1	100	100	0.04	2	90	150	0	0	0
9	1	1	100	100	0.04	2	330	0	0	0	1
10	1	1	100	100	0.04	2	210	0	0	0	1
11	2	2	150	200	0.06	4	150	150	0	0	0
12	2	2	150	200	0.06	4	30	0	0	0	1
13	2	2	150	200	0.06	4	270	0	0	0	1

During the editing of the CSV files, corresponding waveform codes are as shown in the table below. The triggering types of List file are TIME and TRIG. TIME is represented by 0, TRIG 1.

Wave	Code
Sin	0
Square	1
Triangle	2
Exp	3
Ramp_rise	4
Ramp_fall	5
Sin_Pos	6
Sin_Neg	7
THDWave	8
2nd_Step	9
2nd_impulse	10
Self-defined waves	11~15

4. Insert the USB disk into the USB interface of the front panel. Press **[List]** on the front panel to enter the List function configuration interface.
5. Press **[Recall Config]**. Select the List02 csv file and open it. The List file will be imported, as shown in the figure below.



- Press soft key **[Edit Current]**, all parameters of the list document will display, as shown in the figure below.

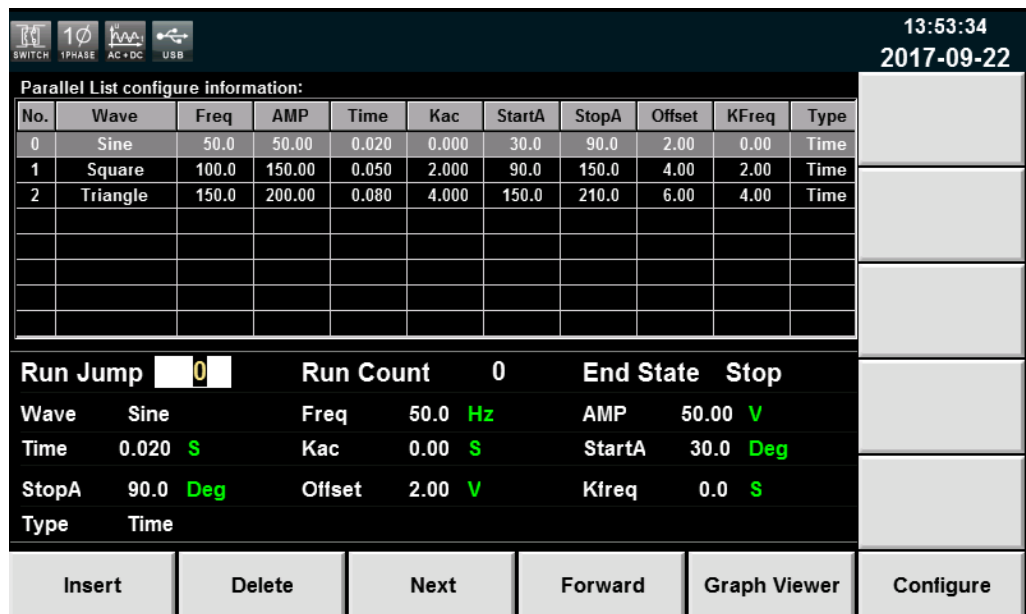

Export List file

After editing the List file, the user can directly save it into the device or export and save it into the peripheral memory disc. The exported List is saved in the format of (*.csv). Detailed operation steps are as below:

- Insert the U disk into the USB interface of the front panel.
- Press **[List]** on the front panel to enter the List function configuration interface.
- Press **[Export Config]**. Select the saved List02 csv file, press **[Enter]** to confirm. This file will be exported into the USB disk.

8.1.5 Run List file

The user can run power the created List file as needed to enable outputting of corresponding waveform sequence by the power supply. Detailed operation steps are as below:

1. Press **[On]** on the front panel. The power supply will start running once the trigger signal is received, according to the selected trigger mode. "Running" will appear in the right lower corner of the interface, as shown in the figure below.

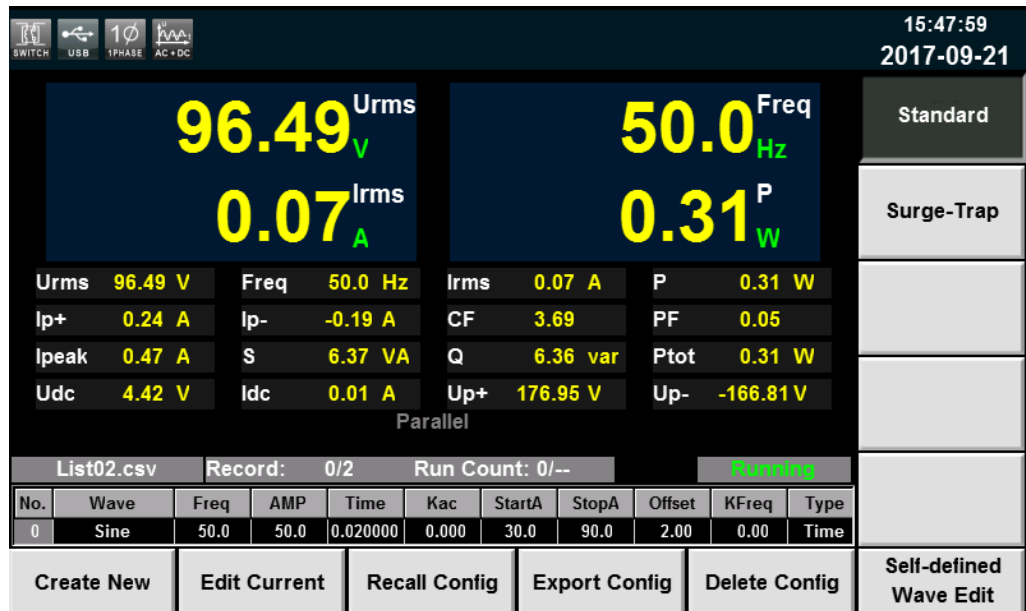

2. Press **[Scope]** to display the wave.

8.1.6 Set trigger source

IT7600 series has four trigger source to choose: trigger by keys (Key), Software trigger (Software), Bus trigger (Bus) and External signal trigger (External). (Refer to 3.16 Trigger Function for more details). You can select trigger source according to various test requirements

8.2 Setting of Surge/trapped Configuration

IT7600 provides surge/trap simulation. The user can add surge/trap to simulate abnormal voltage fluctuation on the basis of outputting Sin wave, and test usage of the DUT under this circumstance.

Operating steps

1. Press **[List]** on the front panel to enter the List function configuration interface.
2. Press **[Surge-Trap]** in the List interface to enter the surge/trap parameter setup interface, as shown in the figure below.

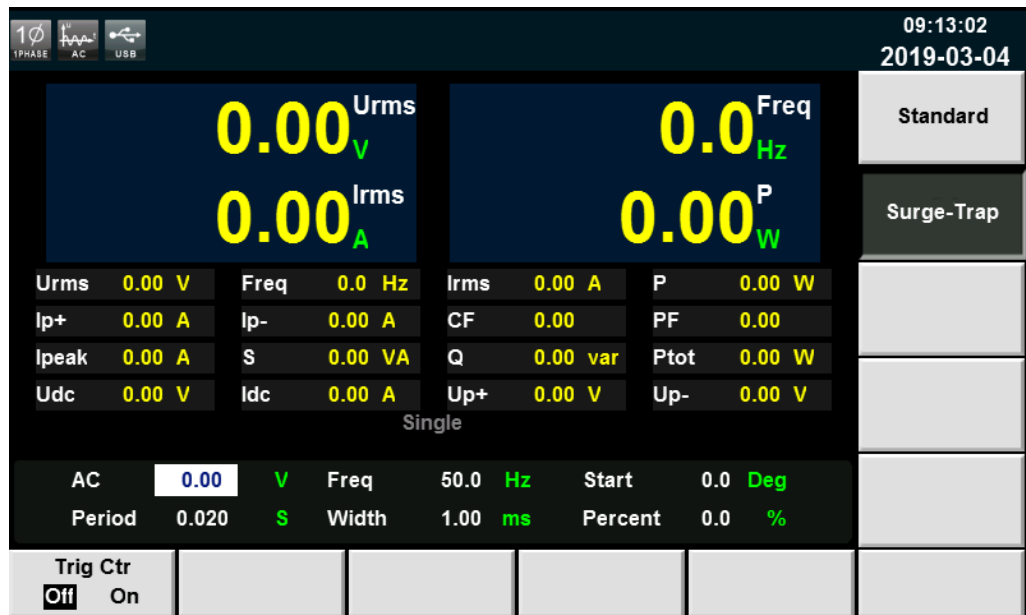

Parameters of the surge/trap edit zone are as follows:

Parameter	Explain
AC	Set the AC signal amplitude (RMS).
Freq	Set the AC signal frequency.
Start	Set the start phase angle of the surge/trap.
Period	Set the period of the surge/trap.
Width	Set the surge/trap width.
Percent	Set the percentage of the surge/trap amplitude to AC signal amplitude (RMS).

- Press **[Trig Ctr]** to set the Off/On state of trigger control.
 Off: run the set surge/trap based on the time.
 On: run the set surge/trap after receiving the trigger signal.
- After setting the parameters, press **[On]** on the front panel. Then press **[Scope]**, and the following waveform interface will appear.

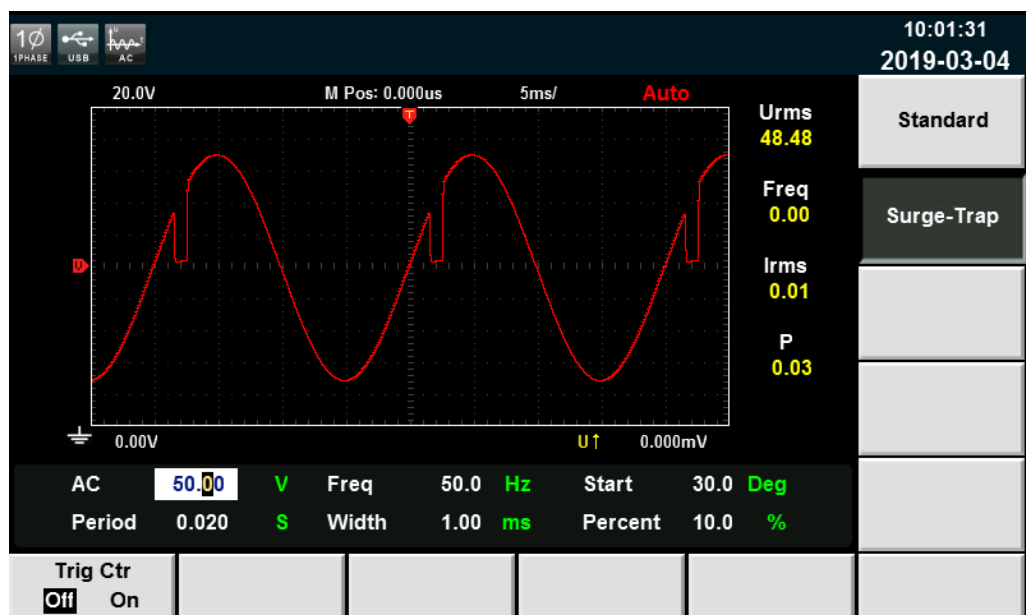

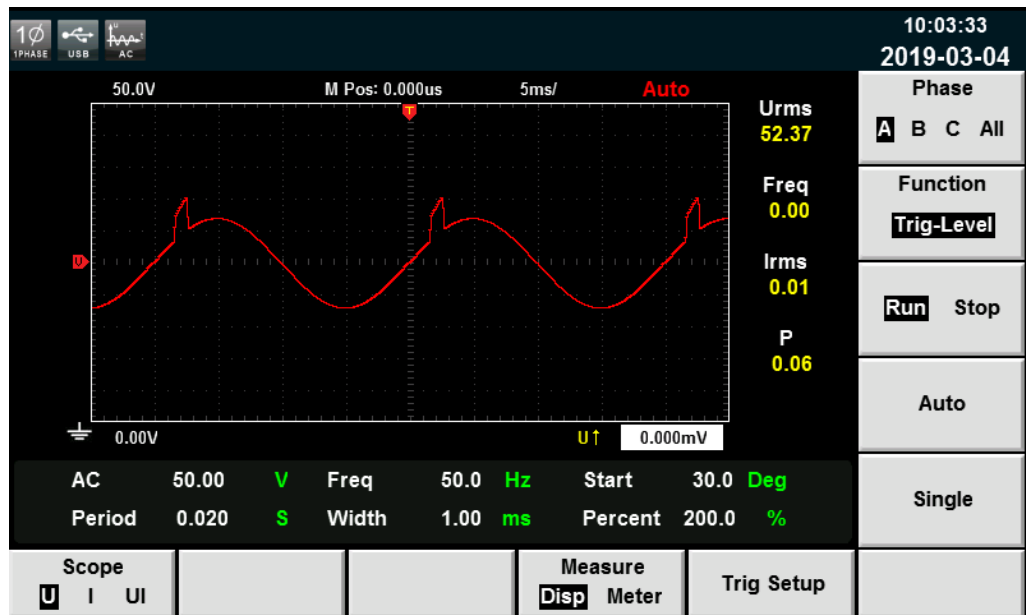

8.3 Self-defined Waveform Function

Self-defined Wave Edit is mainly used for selecting corresponding waveform during List operation. The new waveform file, after saving, will be added after the original waveform file. The user can self-define five waveform files at maximum.

Create a new waveform file

1. Press **[List]** on the front panel, and enter the **[Self-defined Wave Edit]** interface to configure the waveform, as shown in the figure below.

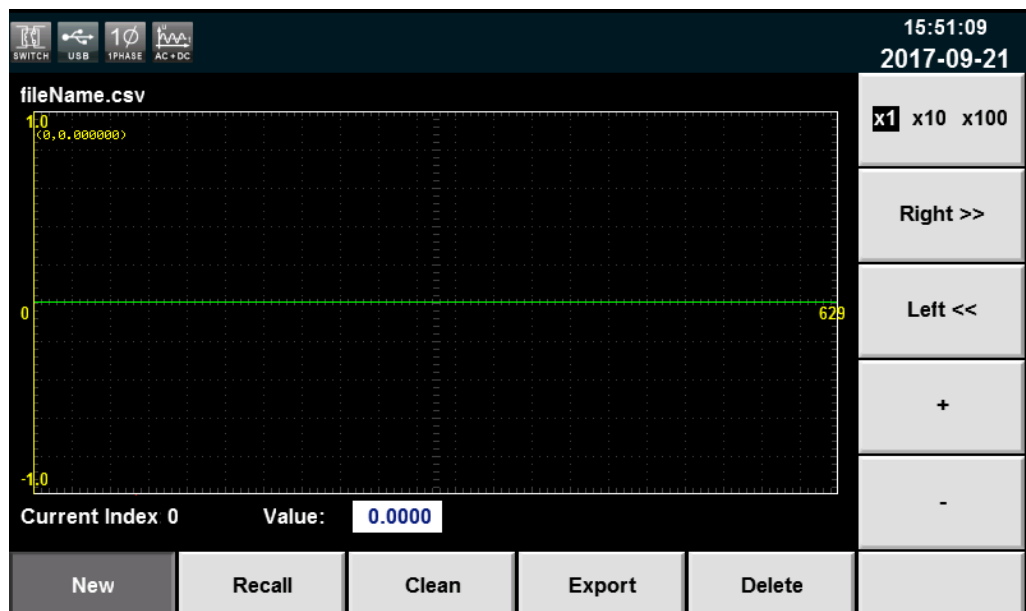

Recall: recall the saved waveform file.

Clean: clean the waveform file.

Export: export the waveform file.

- Delete: delete the waveform file.
2. Press **[New]** and create a new waveform file.
 3. Set “Current Index” and “Value” in the waveform file.
 - X1 X10 X100: multiples of Current Index.
 - Right: Right move current index, max 1023
 - Left: Left move current index, min 0
 - +: increase the current Value, max. 1.0.
 - : decrease the current Value, min. -1.0.
 4. Press **[Shift] + [Recall]** to Save the set waveform file

Import a self-defined waveform file

IT7600 series provide external import function of self-defined waveform file. The user can finish the editing of List file in Excel and import it into the software. This function simplifies the List file edit and facilitates user operation.

Detailed operation steps are as below:

1. Create a new Excel document on local PC and name it harWave.
2. Open the Excel document and save it as in “other formats” in “(*.csv)”.
3. Open the harWave csv file and edit the waveform. Set every step of the List and corresponding parameters (1,024 coordinate points can be set, and only first 9 coordinate points are displayed below) and save the file in the USB disk.

	A	B
1	wave	1024
2	0	-1
3	1	-1
4	2	-1
5	3	-1
6	4	-1
7	5	-1
8	6	-1
9	7	-1
10	8	-1

4. Insert the USB disk into the USB interface of the front panel. Press **[List]** on the front panel to enter the List function configuration interface. Press soft key **[Self-defined Wave Edit]**.
5. Press soft key **[Recall]**. Select the harWave csv file. Press **[Enter]** for confirmation. This List file will be imported. As shown below.

Sin wave voltage and test the usage of the DUT under this circumstance.

Operating steps

1. Select the wave in the main interface, the tab “**THD Config**” will appear under the page. Press [**THD Config**] to enter the **THD Wave Configure** interface, as shown in the figure below.

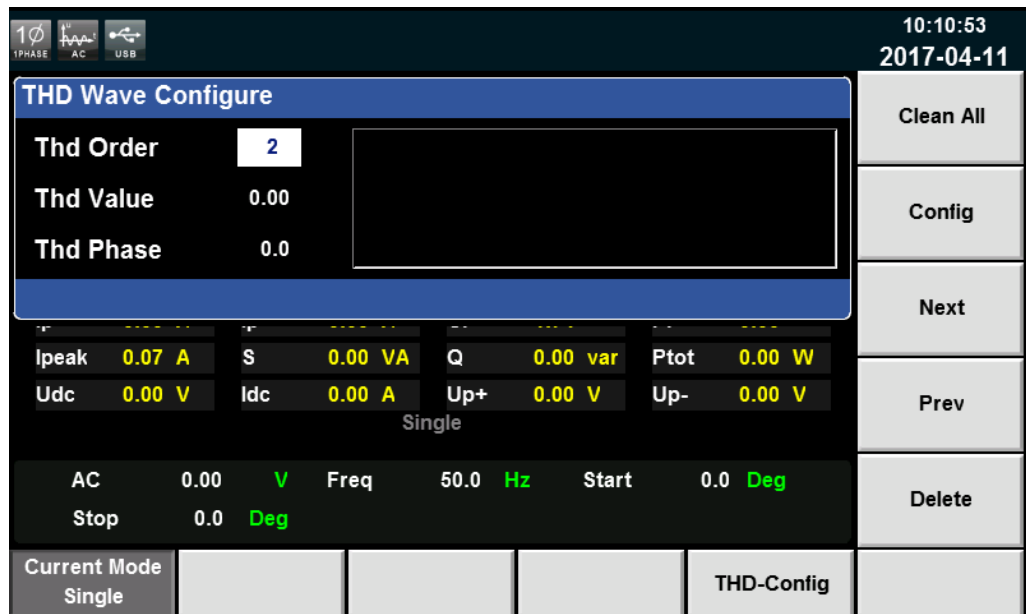

Parameter	Explain
Thd Order	Set the order number.
Thd Value	Set the corresponding harmonic distortion factor within the range 0 to 0.3.
Thd Phase	Set the corresponding harmonic phase within the range 0° to 360°.
Clean	Clear all the set THD waveforms.
Config	Configure the THD waveform.
Next	View next THD parameter.
Prev	View the previous THD parameter.
Delete	Delete the THD parameter.

2. Set the harmonic distortion waveform, and press [**Enter**]. The set parameter will be displayed in the right zone, as shown in the figure below.

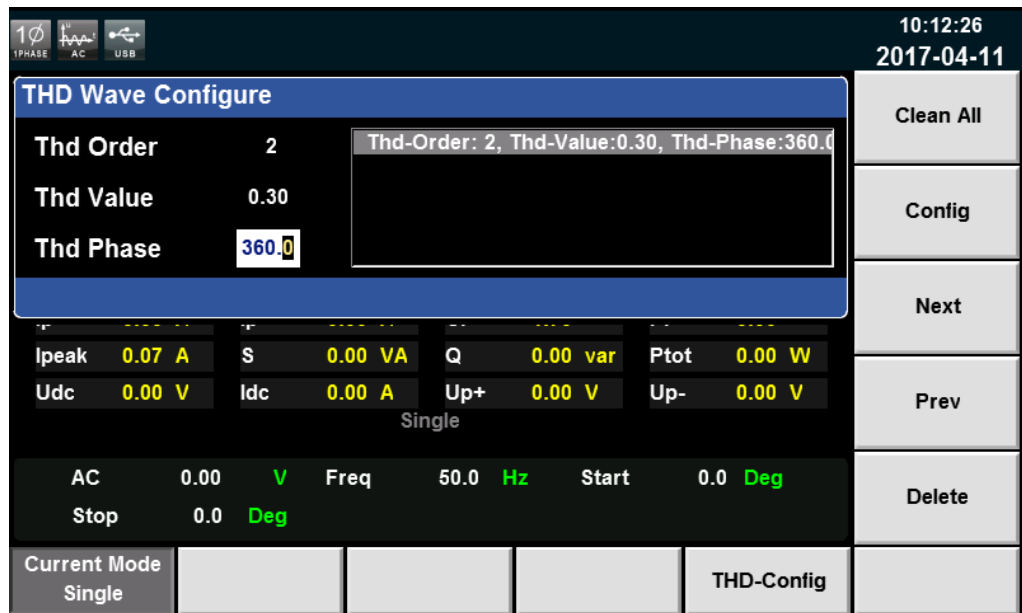

10:12:26
2017-04-11

THD Wave Configure

Thd Order: 2, Thd-Value:0.30, Thd-Phase:360.0

Thd Order: 2
Thd Value: 0.30
Thd Phase: 360.0

Clean All

Config

Next

Prev

Delete

Ipeak 0.07 A S 0.00 VA Q 0.00 var Ptot 0.00 W
Udc 0.00 V Idc 0.00 A Up+ 0.00 V Up- 0.00 V
Single

AC 0.00 V Freq 50.0 Hz Start 0.0 Deg
Stop 0.0 Deg

Current Mode Single THD-Config

- Then press **[Shift] + [Recall]** (Save) on the front panel to save this parameter.

Chapter9 Technical Specifications

This chapter will introduce the main technical parameters of IT7600, such as rated voltage/current/power and so on. Besides, this part will introduce the working environment and storage temperature.

9.1 Main technical parameters

Parameter		IT7622	V1.4
AC Input			
Voltage	220Vac±10% or 110Vac±10%		
Phase	1φ		
Frequency	47-63Hz		
Max.Current	20A/40A		
Power Factor	0.7(Typical)		
AC Output			
Max. output power	750VA		
Voltage range	High:2V-300V, Low:1V-150V, Auto:1V-150V/2V-300V		
Voltage resolution	10mV		
Voltage accuracy(loop:fast) ^{*1}	$\pm 0.2\% + (0.2\% + 0.2\% \times K \text{freq}) \times FS$ ^{*2}		
Voltage accuracy(loop:slow) ^{*1}	$\pm 0.3\% + (0.3\% + 0.3\% \times K \text{freq}) \times FS$ ^{*2}		
Temp. coefficient	$\pm(0.04\% \text{ per degree from } 25^{\circ}\text{C})$		
Max Current(rms)	1-150Vac	0-6Arms	
	2-300Vac	0-3Arms	
Max Current(peak)	90-125Vac	0-18Apeak	
	180-250Vac	0-9Apeak	
Total Harmonic Distortion ^{*3}	$\leq 0.5\%$ at 10-500Hz (Resistive Load)		
	$\leq 2\%$ at 501-5000Hz (Resistive Load)		
Crest Factor	3(Typical)		
Line Regulation	$\leq 0.1\%FS$ (Resistive Load)		
Load Regulation	$\leq 0.5\%FS$ (Resistive Load)		
Dynamic Response Time	$\leq 100\mu\text{s}$ (Typical)		
Output Phase	single phase		
DC Output			

Max. output power		375W
Voltage output		$\pm 212\text{V}/\pm 424\text{V}^{*6}$
Voltage resolution		10mV
Voltage output and readback Accuracy		$\pm(0.2\%+0.2\%FS)^{*7}$
Temp. coefficient		$\pm(0.04\%$ per degree from 25°C)
Current range		3A/1.5A
Current resolution		10mA
Current readback accuracy		$\pm(0.3\%+0.3\%FS)^{*7}$
Power meter accuracy		$\pm(0.4\%+0.4\%FS)^{*7}$
Voltage ripple	Peak	300mVp-p
	Rms	150mVrms
Meter		
AC voltage	Range	0-300Vac
	Resolution	10mV
	Accuracy	$\pm(0.2\%+0.2\%FS)$
	Temp. coefficient	$\pm(0.04\%$ per degree from 25°C)
AC current (rms)	Range	0-6Arms
	Resolution	10mA
	Accuracy	$\pm 0.3\%+(0.3\%+0.2\% \times Kfreq) \times FS^{*2}$
	Temp. coefficient	$\pm(0.04\%$ per degree from 25°C)
AC current (peak)	Range	0-18Apeak
	Resolution	10mA
	Accuracy	$\pm 0.3\%+(0.3\%+0.2\% \times Kfreq) \times FS^{*2}$
	Temp. coefficient	$\pm(0.04\%$ per degree from 25°C)
Power	Resolution	10mW
	Accuracy	$\pm 0.4\%+(0.4\%+0.3\% \times Kfreq) \times FS^{*2}$
	Temp. coefficient	$\pm(0.04\%$ per degree from 25°C)
Phase Angle	Range	0-360°
	Resolution	1°
	Accuracy	$\pm 1^\circ(45-65\text{Hz})^{*5}$
Frequency	Range	10Hz-5KHz

	Resolution	0.1Hz
	Accuracy	$\pm 0.1\% + 0.1\text{Hz}(45\text{Hz}-999.9\text{Hz}) / \pm 0.1\% + 1\text{Hz}(1\text{KHz}-5\text{KHz})^{*4}$
Other		
Protection	OPP,OCP,OTP	
Interface	GPIB,USB,LAN,RS232,CAN	
Dimension (WxHxD)	3u	
Weight	45Kg	

*1: Precondition for voltage accuracy: Slow loop speed: 10-100Hz, Fast loop speed: 10-5KHz;

*2: FS= Full Scale, $V_{rms}=300\text{Vac}$; $I_{rms}=6\text{A}$; $I_{pk}=18\text{A}$; $P=750\text{VA}$;

*3: The minimum voltage of THD test is 10Vac (Auto mode) and 20Vac (High mode).

The maximum distortion test is carried out by outputting the maximum current to linear load under 125Vac (Auto mode) and 250Vac (300V mode).

*4: The test frequency accuracy should ensure that the minimum voltage is 35Vac.

*5: Testing premise is in Fast mode

*6: The minimum voltage setting must not be less than 50Vdc/35Vac.

*7: FS=full: $V_{dc}=424\text{Vdc}$; $I_{dc}=3\text{A}$; $P=375\text{W}$.

Parameter		IT7624	V1.4
AC Input			
Voltage	220Vac $\pm 10\%$ or 110Vac $\pm 10\%$		
Phase	1 ϕ		
Frequency	47-63Hz		
Max.Current	30A/60A		
Power Factor	0.7(Typical)		
AC Output			
Max. output power	1.5KVA		
Voltage range	High:2V-300V, Low:1V-150V, Auto:1V-150V/2V-300V		
Voltage resolution	10mV		
Voltage accuracy(loop:fast) ^{*1}	$\pm 0.2\% + (0.2\% + 0.2\% \times K_{\text{freq}}) \times \text{FS}^{*2}$		
Voltage accuracy(loop:slow) ^{*1}	$\pm 0.3\% + (0.3\% + 0.3\% \times K_{\text{freq}}) \times \text{FS}^{*2}$		
Temp. coefficient	$\pm (0.04\% \text{ per degree from } 25^{\circ}\text{C})$		
Max Current(rms)	1-150Vac	0-12Arms	
	2-300Vac	0-6Arms	

Max Current(peak)	90-125Vac	0-36Apeak
	180-250Vac	0-18Apeak
Total Harmonic Distortion* ³		≤0.5% at 10-500Hz (Resistive Load)
		≤2% at 501-5000Hz (Resistive Load)
Crest Factor		3(Typical)
Line Regulation		≤0.1%FS(Resistive Load)
Load Regulation		≤0.5%FS(Resistive Load)
Dynamic Response Time		≤100us(Typical)
Output Phase		single phase
DC Output		
Max. output power		750W
Voltage output		±212V/±424V* ⁶
Voltage resolution		10mV
Voltage output and readback Accuracy		±(0.2%+0.2%FS)* ⁷
Temp. coefficient		±(0.04% per degree from 25°C)
Current range		6A/3A
Current resolution		10mA
Current readback accuracy		±(0.3%+0.3%FS)* ⁷
Power meter accuracy		±(0.4%+0.4%FS)* ⁷
Voltage ripple	Peak	300mVp-p
	Rms	150mVrms
Meter		
AC voltage	Range	0-300Vac
	Resolution	10mV
	Accuracy	±(0.2%+0.2%FS)
	Temp. coefficient	±(0.04% per degree from 25°C)
AC current (rms)	Range	0-12Arms
	Resolution	10mA
	Accuracy	±0.3%+(0.3%+0.2%×Kfreq)×FS* ²
	Temp. coefficient	±(0.04% per degree from 25°C)
AC current (peak)	Range	0-36Apeak
	Resolution	10mA

	Accuracy	$\pm 0.3\% + (0.3\% + 0.2\% \times K_{\text{freq}}) \times FS^{*2}$
	Temp. coefficient	$\pm (0.04\% \text{ per degree from } 25^{\circ}\text{C})$
Power	Resolution	10mW
	Accuracy	$\pm 0.4\% + (0.4\% + 0.2\% \times K_{\text{freq}}) \times FS^{*2}$
	Temp. coefficient	$\pm (0.04\% \text{ per degree from } 25^{\circ}\text{C})$
Phase Angle	Range	0-360°
	Resolution	1°
	Accuracy	$\pm 1^{\circ} (45-65\text{Hz})^{*5}$
Frequency	Range	10Hz-5KHz
	Resolution	0.1Hz
	Accuracy	$\pm 0.1\% + 0.1\text{Hz} (45\text{Hz}-999.9\text{Hz}) / \pm 0.1\% + 1\text{Hz} (1\text{KHz}-5\text{KHz})^{*4}$
Other		
Protection	OPP,OCP,OTP	
Interface	GPIB,USB,LAN,RS232,CAN	
Dimension (WxHxD)	3u	
Weight	50Kg	

*1: Precondition for voltage accuracy: Slow loop speed: 10-100Hz; Fast loop speed: 10-5KHz.

*2: FS= Full Scale: $V_{\text{rms}}=300\text{Vac}$, $I_{\text{rms}}=12\text{A}$; $I_{\text{pk}}=36\text{A}$; $P=1500\text{VA}$.

*3: The minimum voltage of THD test is 10Vac (Auto mode) and 20Vac (High mode).

The maximum distortion test is carried out by outputting the maximum current to linear load under 125Vac (Auto mode) and 250Vac (300V mode).

*4: The test frequency accuracy should ensure that the minimum voltage is 35Vac.

*5: Testing premise is in Fast mode

*6: The minimum voltage setting must not be less than 50Vdc/35Vac.

*7: FS=full: $V_{\text{dc}}=424\text{Vdc}$; $I_{\text{dc}}=6\text{A}$; $P=750\text{W}$.

Parameter	IT7625	V1.1
AC Input		
Voltage	380Vac $\pm 10\%$ (Y)	
Phase	3 ϕ	
Frequency	47-63Hz	
Max.Current	30A	
Power Factor	0.7(Typical)	

AC Output		
Output Phase	1φ or 3φ	
Max. output power	4.5KVA	
Max. output power of each phase	1.5KVA	
Voltage range	High:2V-300V, Low:1V-150V, Auto:1V-150V/2V-300V	
Voltage resolution	10mV	
Voltage accuracy(loop:fast) ^{*1}	$\pm 0.2\% + (0.2\% + 0.2\% \times \text{Kfreq}) \times \text{FS}^{*2}$	
Voltage accuracy(loop:slow) ^{*1}	$\pm 0.3\% + (0.3\% + 0.3\% \times \text{Kfreq}) \times \text{FS}^{*2}$	
Temp. coefficient	$\pm (0.04\% \text{ per degree from } 25^{\circ}\text{C})$	
Max.Current(1φ)	RMS	36A/18A ^{*8}
	Peak(CF=3)	108A/54A ^{*8}
Max.Current(3φ)	RMS	12A/6A
	Peak(CF=3)	36A/18A
Total Harmonic Distortion ^{*3}	$\leq 0.5\%$ at 10-500Hz (Resistive Load)	
	$\leq 2\%$ at 501-5000Hz (Resistive Load)	
Crest Factor	3	
Line Regulation	$\leq 0.1\% \text{FS}(\text{Resistive Load})$	
Load Regulation	$\leq 0.5\% \text{FS}(\text{Resistive Load})$	
Dynamic Response Time	$\leq 200\mu\text{s}(\text{Typical})$	
DC Output		
Max. output power	2.25KW	
Voltage output	$\pm 212\text{V}/\pm 424\text{V}^{*6}$	
Voltage resolution	10mV	
Voltage output and readback Accuracy	$\pm (0.2\% + 0.2\% \text{FS})^{*7}$	
Temp. coefficient	$\pm (0.04\% \text{ per degree from } 25^{\circ}\text{C})$	
Current range	18A/9A	
Current resolution	10mA	
Current readback accuracy	$\pm (0.3\% + 0.3\% \text{FS})^{*7}$	
Power meter accuracy	$\pm (0.4\% + 0.4\% \text{FS})^{*7}$	
Voltage ripple	Peak	500mVp-p
	Rms	200mVrms
Meter		

AC voltage	Range	0-300Vac
	Resolution	10mV
	Accuracy	$\pm(0.2\%+0.2\%FS)$
	Temp. coefficient	$\pm(0.04\%$ per degree from 25°C)
AC current (rms)	Range	0-36Arms
	Resolution	10mA
	Accuracy	$\pm 0.3\%+(0.3\%+0.2\% \times Kfreq) \times FS^{*2}$
	Temp. coefficient	$\pm(0.04\%$ per degree from 25°C)
AC current (peak)	Range	0-108Apeak
	Resolution	10mA
	Accuracy	$\pm 0.3\%+(0.3\%+0.2\% \times Kfreq) \times FS^{*2}$
	Temp. coefficient	$\pm(0.04\%$ per degree from 25°C)
Power	Resolution	10mW
	Accuracy	$\pm 0.4\%+(0.4\%+0.2\% \times Kfreq) \times FS^{*2}$
	Temp. coefficient	$\pm(0.04\%$ per degree from 25°C)
Phase Angle	Range	0-360°
	Resolution	1°
	Accuracy	$\pm 1^\circ(45-65Hz)^{*5}$
Frequency	Range	10Hz-5KHz
	Resolution	0.1Hz
	Accuracy	$\pm 0.1\%+0.1Hz(10Hz-999.9Hz)/\pm 0.1\%+1Hz(1KHz-5KHz)^{*4}$
Other		
Protection	OPP,OCP,OTP	
Interface	GPIB,USB,LAN,RS232,CAN	
Memory	10 groups	
Dimension(WxHxD)	15u	

*1: Preconditions for voltage accury: Slow loop speed: 10-100Hz, Fast loop speed: 10-5KHz;

*2: FS=full scale, Vrms 300Vac; Irms=36A; Ipk=108A; P=4500VA;

*3: The minimum voltage of THD test is 10Vac (Auto mode) and 20Vac (High mode).

The maximum distortion test is carried out by outputting the maximum current to linear load under 125Vac (Auto mode) and 250Vac (300V mode).

*4: The test frequency accuracy should ensure that the minimum voltage is 35Vac.

*5: Testing premise is in Fast mode.

*6: The minimum voltage setting must not be less than 50Vdc/35Vac.

*7: FS=full scale; Vdc=424Vdc; Idc=18A; P=2250W;

*8: The maximum current range is 95% in the parallel mode.

Parameter		IT7626	V1.7
AC Input			
Voltage		220Vac±10%	
Phase		1φ	
Frequency		47-63Hz	
Max.Current		60A	
Power Factor		0.7(Typical)	
AC Output			
Max. output power		3KVA	
Voltage range		High:2V-300V, Low:1V-150V, Auto:1V-150V/2V-300V	
Voltage resolution		10mV	
Voltage accuracy (loop:fast) ^{*1}		±0.2%+(0.2%+0.2%×Kfreq)×FS ^{*2}	
Voltage accuracy (loop:slow) ^{*1}		±0.3%+(0.3%+0.3%×Kfreq)×FS ^{*2}	
Temp. coefficient		±(0.04% per degree from 25°C)	
Max Current(rms)	1-150Vac	0-24Arms	
	2-300Vac	0-12Arms	
Max Current(peak)	90-125Vac	0-72Apeak	
	180-250Vac	0-36Apeak	
Total Harmonic Distortion ^{*3}		≤0.5% at 10-500Hz (Resistive Load)	
		≤2% at 501-5000Hz (Resistive Load)	
Crest Factor		3(Typical)	
Line Regulation		≤0.1%FS(Resistive Load)	
Load Regulation		≤0.5%FS(Resistive Load)	
Dynamic Response Time		≤100us(Typical)	
Output Phase		single phase	
DC Output			
Max. output power		1.5KW	
Voltage output		±212V/±424V ^{*6}	
Voltage resolution		10mV	

Voltage output and readback Accuracy		$\pm(0.2\%+0.2\%FS)^{*7}$
Temp. coefficient		$\pm(0.04\%$ per degree from 25°C)
Current range		12A/6A
Current resolution		10mA
Current readback accuracy		$\pm(0.3\%+0.3\%FS)^{*7}$
Power meter accuracy		$\pm(0.4\%+0.4\%FS)^{*7}$
Voltage ripple	Peak	300mVp-p
	Rms	150mVrms
Meter		
AC voltage	Range	0-300Vac
	Resolution	10mV
	Accuracy	$\pm(0.2\%+0.2\%FS)$
	Temp. coefficient	$\pm(0.04\%$ per degree from 25°C)
AC current (rms)	Range	0-24Arms
	Resolution	10mA
	Accuracy	$\pm 0.3\%+(0.3\%+0.2\% \times Kfreq) \times FS^{*2}$
	Temp. coefficient	$\pm(0.04\%$ per degree from 25°C)
AC current (peak)	Range	0-72Apeak
	Resolution	10mA
	Accuracy	$\pm 0.3\%+(0.3\%+0.2\% \times Kfreq) \times FS^{*2}$
	Temp. coefficient	$\pm(0.04\%$ per degree from 25°C)
Power	Resolution	10mW
	Accuracy	$\pm 0.4\%+(0.4\%+0.2\% \times Kfreq) \times FS^{*2}$
	Temp. coefficient	$\pm(0.04\%$ per degree from 25°C)
Phase Angle	Range	0-360°
	Resolution	1°
	Accuracy	$\pm 1^{\circ}(45-65Hz)^{*5}$
Frequency	Range	10Hz-5KHz
	Resolution	0.1Hz
	Accuracy	$\pm 0.1\%+0.1Hz(10Hz-999.9Hz)/\pm 0.1\%+1Hz(1KHz-5KHz)^{*4}$
Other		

Protection	OPP,OCP,OTP
Interface	GPIB,USB,LAN,RS232,CAN
Memory	10groups
Dimension(WxHxD)	6u
Weight	100Kg

*1: Preconditions for voltage accuracy: Slow loop speed: 10-100Hz; Fast loop speed: 10-5KHz.

*2: FS=full scale: $V_{rms}=300Vac$, $I_{rms}=24A$; $I_{pk}=72A$; $P=3000VA$.

*3: The minimum voltage of THD test is 10Vac (Auto mode) and 20Vac (High mode).

The maximum distortion test is carried out by outputting the maximum current to linear load under 125Vac (Auto mode) and 250Vac (300V mode).

*4: The test frequency accuracy should ensure that the minimum voltage is 35Vac.

*5: Testing premise is in Fast mode

*6: The minimum voltage setting must not be less than 50Vdc/35Vac.

*7: FS=full scale: $V_{dc}=424Vdc$; $I_{dc}=12A$; $P=1500W$.

Parameter		IT7627	V1.4
AC Input			
Voltage		380Vac \pm 10%(Y)	
Phase		3 ϕ	
Frequency		47-63Hz	
Max.Current		60A	
Power Factor		0.7(Typical)	
AC Output			
Output Phase		1 ϕ or 3 ϕ	
Max. output power		9KVA	
Max.output power of each phase		3KVA	
Voltage range		High:2V-300V, Low:1V-150V, Auto:1V-150V/2V-300V	
Voltage resolution		10mV	
Voltage accuracy(loop:fast) ^{*1}		$\pm 0.2\% + (0.2\% + 0.2\% \times Kfreq) \times FS^{*2}$	
Voltage accuracy(loop:slow) ^{*1}		$\pm 0.3\% + (0.3\% + 0.3\% \times Kfreq) \times FS^{*2}$	
Temp. coefficient		$\pm(0.04\%$ per degree from 25°C)	
Max.Current(1 ϕ)	RMS	72A/36A ^{*8}	
	Peak(CF=3)	216A/108A ^{*8} (Typical)	

Max.Current(3φ)	RMS	24A/12A
	Peak(CF=3)	72A/36A (Typical)
Total Harmonic Distortion ^{*3}		≤0.5% at 10-500Hz (Resistive Load)
		≤2% at 501-5000Hz (Resistive Load)
Crest Factor		3(Typical)
Line Regulation		≤0.1%FS(Resistive Load)
Load Regulation		≤0.5%FS(Resistive Load)
Dynamic Response Time		≤200us(Typical)
DC Output		
Max. output power		4.5KW
Voltage output		±212V/±424V ^{*6}
Voltage resolution		10mV
Voltage output and readback Accuracy		±(0.2%+0.2%FS) ^{*7}
Temp. coefficient		±(0.04% per degree from 25°C)
Current range		36A/18A
Current resolution		10mA
Current readback accuracy		±(0.3%+0.3%FS) ^{*7}
Power meter accuracy		±(0.4%+0.4%FS) ^{*7}
Voltage ripple	Peak	500mVp-p
	Rms	200mVrms
Meter		
AC voltage	Range	0-300Vac
	Resolution	10mV
	Accuracy	±(0.2%+0.2%FS)
	Temp. coefficient	±(0.04% per degree from 25°C)
AC current (rms)	Range	0-72Arms
	Resolution	10mA
	Accuracy	±0.3%+(0.3%+0.2%×Kfreq)×FS ^{*2}
	Temp. coefficient	±(0.04% per degree from 25°C)
AC current (peak)	Range	0-216Apeak
	Resolution	10mA

	Accuracy	$\pm 0.3\% + (0.3\% + 0.2\% \times K_{\text{freq}}) \times FS^{*2}$
	Temp. coefficient	$\pm (0.04\% \text{ per degree from } 25^{\circ}\text{C})$
Power	Resolution	10mW
	Accuracy	$\pm 0.4\% + (0.4\% + 0.2\% \times K_{\text{freq}}) \times FS^{*2}$
	Temp. coefficient	$\pm (0.04\% \text{ per degree from } 25^{\circ}\text{C})$
Phase Angle	Range	0-360°
	Resolution	1°
	Accuracy	$\pm 1^{\circ} (45-65\text{Hz})^{*5}$
Frequency	Range	10Hz-5KHz
	Resolution	0.1Hz
	Accuracy	$\pm 0.1\% + 0.1\text{Hz} (10\text{Hz}-999.9\text{Hz}) / \pm 0.1\% + 1\text{Hz} (1\text{KHz}-5\text{KHz})^{*4}$
Other		
Protection	OPP,OCP,OTP	
Interface	GPIB,USB,LAN,RS232,CAN	
Memory	10 groups	
Dimension(WxHxD)	27u	

*1: Preconditions for voltage accuracy: Slow loop speed: 10-100Hz; Fast loop speed: 10-5KHz.

*2: FS=full scale: $V_{\text{rms}}=300\text{Vac}$, $I_{\text{rms}}=72\text{A}$; $I_{\text{pk}}=216\text{A}$; $P=9000\text{VA}$;

*3: The minimum voltage of THD test is 10Vac(Auto mode) and 20Vac(High mode).

The maximum distortion test is carried out by outputting the maximum current to linear load under 125Vac (Auto mode) and 250Vac (300V mode).

*4: The test frequency accuracy should ensure that the minimum voltage is 35Vac.

*5: Testing premise is in Fast mode

*6: The minimum voltage setting must not be less than 50Vdc/35Vac.

*7: FS=full scale: $V_{\text{dc}}=424\text{Vdc}$; $I_{\text{dc}}=36\text{A}$; $P=4500\text{W}$;

*8: The maximum current range is 95% in the parallel mode.

Meet CF=3, the voltage in low range is 90 to 125 Vac and in high range is 180 to 250Vac.

Parameter	IT7628	V1.5
AC Input		
Voltage	380Vac $\pm 10\%$ (Y)	
Phase	3 ϕ	
Frequency	47-63Hz	
Max.Current	120A	

Power Factor	0.7(Typical)	
AC Output		
Output Phase	1φ or 3φ	
Max. output power	18KVA	
Max.output power of each phase	6KVA	
Voltage range	High:2V-300V, Low:1V-150V, Auto:1V-150V/2V-300V	
Voltage resolution	10mV	
Voltage accuracy(loop:fast) ^{*1}	$\pm 0.2\% + (0.2\% + 0.2\% \times Kfreq) \times FS^{*2}$	
Voltage accuracy(loop:slow) ^{*1}	$\pm 0.3\% + (0.3\% + 0.3\% \times Kfreq) \times FS^{*2}$	
Temp. coefficient	$\pm (0.04\% \text{ per degree from } 25^{\circ}\text{C})$	
Max.Current(1φ)	RMS	144A/72A ^{*8}
	Peak(CF=3)	432A/216A ^{*8} (Typical)
Max.Current(3φ)	RMS	48A/24A
	Peak(CF=3)	144A/72A(Typical)
Total Harmonic Distortion ^{*3}	$\leq 0.5\%$ at 10-500Hz (Resistive Load)	
	$\leq 2\%$ at 501-5000Hz (Resistive Load)	
Crest Factor	3(Typical)	
Line Regulation	$\leq 0.1\%FS$ (Resistive Load)	
Load Regulation	$\leq 0.5\%FS$ (Resistive Load)	
Dynamic Response Time	$\leq 200\mu\text{s}$ (Typical)	
DC Output		
Max. output power	9KW	
Voltage output	$\pm 212V/\pm 424V^{*6}$	
Voltage resolution	10mV	
Voltage output and readback Accuracy	$\pm (0.2\% + 0.2\%FS)^{*7}$	
Temp. coefficient	$\pm (0.04\% \text{ per degree from } 25^{\circ}\text{C})$	
Current range	72A/36A	
Current resolution	10mA	
Current readback accuracy	$\pm (0.3\% + 0.3\%FS)^{*7}$	
Power meter accuracy	$\pm (0.4\% + 0.4\%FS)^{*7}$	
Voltage ripple	Peak	600mVp-p
	Rms	300mVrms

Meter		
AC voltage	Range	0-300Vac
	Resolution	10mV
	Accuracy	$\pm(0.2\%+0.2\%FS)$
	Temp. coefficient	$\pm(0.04\%$ per degree from 25°C)
AC current (rms)	Range	0-144Arms
	Resolution	10mA
	Accuracy	$\pm 0.3\%+(0.3\%+0.3\% \times Kfreq) \times FS^{*2}$
	Temp. coefficient	$\pm(0.04\%$ per degree from 25°C)
AC current (peak)	Range	0-432Apeak
	Resolution	10mA
	Accuracy	$\pm 0.3\%+(0.3\%+0.3\% \times Kfreq) \times FS^{*2}$
	Temp. coefficient	$\pm(0.04\%$ per degree from 25°C)
Power	Resolution	10mW
	Accuracy	$\pm 0.4\%+(0.4\%+0.4\% \times Kfreq) \times FS^{*2}$
	Temp. coefficient	$\pm(0.04\%$ per degree from 25°C)
Phase Angle	Range	0-360°
	Resolution	1°
	Accuracy	$\pm 1^\circ(45-65Hz)^{*5}$
Frequency	Range	10Hz-5KHz
	Resolution	0.1Hz
	Accuracy	$\pm 0.1\%+0.1Hz(10Hz-999.9Hz)/\pm 0.1\%+1Hz(1KHz-5KHz)^{*4}$
Other		
Protection	OPP,OCP,OTP	
Interface	GPIB,USB,LAN,RS232,CAN	
Dimension(WxHxD)	37u	
Weight	750Kg	

*1: Meet the voltage accuracy requirements: Slow loop speed: 10-100Hz; Fast loop speed: 10-5KHz.

*2: FS corresponds to the full range: $V_{rms}=300Vac$; $I_{rms}=144A$; $I_{pk}=432A$; $P=18KVA$;

*3: The minimum voltage of THD test is 10Vac (Auto mode) and 20Vac (High mode).

The maximum distortion test is carried out by outputting the maximum current to linear load under 125Vac (Auto mode) and 250Vac (300V mode).

*4: The test frequency accuracy should ensure that the minimum voltage is 35Vac.

*5: The test mode is Fast.

*6: The minimum voltage setting must not be less than 50Vdc/35Vac.

*7: FS corresponds to the full range: Vdc=424Vdc;Idc=72A;P=9000W;

*8: The maximum current range is 95% in the parallel mode.

Meet CF=3, the voltage in low range is 90 to 125 Vac and in high range is 180 to 250Vac.

Parameter		IT7628L Ver V1.5
AC Input		
Voltage		380Vac±10%(Y)
Phase		3 φ
Frequency		47-63Hz
Max.Current		90A
Power Factor		0.7(Typical)
AC Output		
Output Phase		1 φ or 3 φ
Max. output power		13.5KVA
Max.output power of each phase		4.5KVA
Voltage range		High:2V-300V, Low:1V-150V, Auto:1V-150V/2V-300V
Voltage resolution		10mV
Voltage accuracy (loop:fast) ^{*1}		± 0.2%+(0.2%+0.2%×Kfreq)×FS ^{*2}
Voltage accuracy (loop:slow) ^{*1}		± 0.3%+(0.3%+0.3%×Kfreq)×FS ^{*2}
Temp. coefficient		±(0.04% per degree from 25°C)
Max.Current(1 φ)	RMS	108A/54A ^{*8}
	Peak(CF=3)	324A/2162A ^{*8} (Typical)
Max.Current(3 φ)	RMS	36A/18A
	Peak(CF=3)	108A/54A(Typical)
Total Harmonic Distortion ^{*3}		≤0.5% at 10-500Hz (Resistive Load)
		≤2% at 501-5000Hz (Resistive Load)
Crest Factor		3(Typical)
Line Regulation		≤0.1%FS(Resistive Load)
Load Regulation		≤0.5%FS(Resistive Load)
Dynamic Response Time		≤200us(Typical)
DC Output		

Parameter		IT7628L Ver V1.5
Max. output power		6.75KW
Voltage output		$\pm 212V/\pm 424V^{*6}$
Voltage resolution		10mV
Voltage output and readback Accuracy		$\pm (0.2\%+0.2\%FS)^{*7}$
Temp. coefficient		$\pm (0.04\%$ per degree from 25 °C)
Current range		54A/27A
Current resolution		10mA
Current readback accuracy		$\pm (0.3\%+0.3\%FS)^{*7}$
Power meter accuracy		$\pm (0.4\%+0.4\%FS)^{*7}$
Voltage ripple	Peak	600mVp-p
	Rms	300mVrms
Meter		
AC voltage	Range	0-300Vac
	Resolution	10mV
	Accuracy	$\pm (0.2\%+0.2\%FS)$
	Temp. coefficient	$\pm (0.04\%$ per degree from 25 °C)
AC current (rms)	Range	0-108Arms
	Resolution	10mA
	Accuracy	$\pm 0.3\%+(0.3\%+0.3\% \times Kfreq) \times FS^{*2}$
	Temp. coefficient	$\pm (0.04\%$ per degree from 25 °C)
AC current (peak)	Range	0-324Apeak
	Resolution	10mA
	Accuracy	$\pm 0.3\%+(0.3\%+0.3\% \times Kfreq) \times FS^{*2}$
	Temp. coefficient	$\pm (0.04\%$ per degree from 25 °C)
Power	Resolution	10mW
	Accuracy	$\pm 0.4\%+(0.4\%+0.4\% \times Kfreq) \times FS^{*2}$
	Temp. coefficient	$\pm (0.04\%$ per degree from 25 °C)
Phase Angle	Range	0-360°
	Resolution	1°
	Accuracy	$\pm 1^\circ$ (45-65Hz) ^{*5}
Frequency	Range	10Hz-5KHz

Parameter		IT7628L Ver V1.5
	Resolution	0.1Hz
	Accuracy	$\pm 0.1\% + 0.1\text{Hz}(10\text{Hz}-999.9\text{Hz}) / \pm 0.1\% + 1\text{Hz}(1\text{KHz}-5\text{KHz})^{*4}$
Other		
Protection	OPP、OCP、OTP	
Interface	GPIB、USB、LAN、RS232、CAN	
Dimension (WxHxD)	37u	
Weight	770Kg	

*1: Meet the voltage accuracy requirements: Slow loop speed: 15-100Hz; Fast loop speed: 15-5KHz.

*2: FS corresponds to the full range: $V_{rms}=300\text{Vac}$; $I_{rms}=36\text{A}$; $I_{pk}=108\text{A}$; $P=13.5\text{KVA}$;

*3: The minimum voltage of THD test is 10Vac (Auto mode) and 20Vac (High mode).

The maximum distortion test is carried out by outputting the maximum current to linear load under 125Vac (Auto mode) and 250Vac (300V mode).

*4: The test frequency accuracy should ensure that the minimum voltage is 35Vac.

*5: The test mode is Fast.

*6: The minimum voltage setting must not be less than 50Vdc/35Vac.

*7: FS corresponds to the full range: $V_{dc}=424\text{Vdc}$; $I_{dc}=54\text{A}$; $P=6750\text{W}$;

*8: The maximum current range is 95% in the parallel mode.

Meet $CF=3$, the voltage in low range is 90 to 125 Vac and in high range is 180 to 250Vac.

Parameter	IT7630	V1.1
AC Input		
Voltage	380Vac $\pm 10\%$ (Y)	
Phase	3 ϕ	
Frequency	47-63Hz	
Max.Current	60A $\times 3$ ^{*9}	
Power Factor	0.7(Typical)	
AC Output		
Output Phase	3 ϕ	
Max. output power	27KVA	
Max.output power of each phase	9KVA	
Voltage range	High:2V-300V, Low:1V-150V, Auto:1V-150V/2V-300V	

Voltage resolution		10mV
Voltage accuracy(loop:fast) ^{*1}		$\pm 0.2\% + (0.2\% + 0.2\% \times Kfreq) \times FS^{*2}$
Voltage accuracy(loop:slow) ^{*1}		$\pm 0.3\% + (0.3\% + 0.3\% \times Kfreq) \times FS^{*2}$
Temp. coefficient		$\pm(0.04\%$ per degree from 25°C)
Max.Current(3φ)	RMS	72A/36A
	Peak(CF=3)	216A/108A
Total Harmonic Distortion ^{*3}		$\leq 0.5\%$ at 10-500Hz (Resistive Load)
		$\leq 2\%$ at 501-5000Hz (Resistive Load)
Crest Factor		3
Line Regulation		$\leq 0.1\%FS$ (Resistive Load)
Load Regulation		$\leq 0.5\%FS$ (Resistive Load)
Dynamic Response Time		$\leq 200\mu s$ (Typical)
Meter		
AC voltage	Range	0-300Vac
	Resolution	10mV
	Accuracy	$\pm(0.2\% + 0.2\%FS)$
	Temp. coefficient	$\pm(0.04\%$ per degree from 25°C)
AC current (rms)	Range	0-72Arms
	Resolution	10mA
	Accuracy	$\pm 0.3\% + (0.3\% + 0.2\% \times Kfreq) \times FS^{*2}$
	Temp. coefficient	$\pm(0.04\%$ per degree from 25°C)
AC current (peak)	Range	0-216Apeak
	Resolution	10mA
	Accuracy	$\pm 0.3\% + (0.3\% + 0.2\% \times Kfreq) \times FS^{*2}$
	Temp. coefficient	$\pm(0.04\%$ per degree from 25°C)
Power	Resolution	10mW
	Accuracy	$\pm 0.4\% + (0.4\% + 0.2\% \times Kfreq) \times FS^{*2}$
	Temp. coefficient	$\pm(0.04\%$ per degree from 25°C)
Phase Angle	Range	0-360°
	Resolution	1°
	Accuracy	$\pm 3^\circ$ (45-65Hz) ^{*5}

Frequency	Range	10Hz-5KHz
	Resolution	0.1Hz
	Accuracy	$\pm 0.1\% + 0.1\text{Hz}(10\text{Hz}-999.9\text{Hz}) / \pm 0.1\% + 1\text{Hz}(1\text{KHz}-5\text{KHz})$ ^{*4}
Other		
Protection	OPP,OCP,OTP	
Interface	GPIB,USB,LAN,RS232,CAN	
Dimension(WxHxD)	27ux3	

^{*1}: Meet the voltage accuracy requirements: Slow loop speed: 10-100Hz; Fast loop speed: 10-5KHz.

^{*2}: FS corresponds to the full range: $V_{rms}=300\text{Vac}$; $I_{rms}=72\text{A}$; $I_{pk}=216\text{A}$; $P=27\text{KVA}$;

^{*3}: The minimum voltage of THD test is 10Vac (Auto mode) and 20Vac (High mode).

The maximum distortion test is carried out by outputting the maximum current to linear load under 125Vac (Auto mode) and 250Vac (300V mode).

^{*4}: The test frequency accuracy should ensure that the minimum voltage is 35Vac.

^{*5}: The test mode is Fast.

^{*6}: The minimum voltage setting must not be less than 50Vdc/35Vac.

^{*8}: The maximum current range is 95% in the parallel mode.

^{*9}: Three power supplies with 18KVA, max. 3 ϕ input current of each power supply is 60A.

Parameter	IT7632	V1.1
AC Input		
Voltage	380Vac $\pm 10\%$ (Y)	
Phase	3 ϕ	
Frequency	47-63Hz	
Max.Current	120A $\times 3$ ^{*9}	
Power Factor	0.7(Typical)	
AC Output		
Output Phase	3 ϕ	
Max. output power	36KVA	
Max.output power of each phase	12KVA	
Voltage range	High:2V-300V, Low:1V-150V, Auto:1V-150V/2V-300V	
Voltage resolution	10mV	
Voltage accuracy(loop:fast) ^{*1}	$\pm 0.2\% + (0.2\% + 0.2\% \times \text{Kfreq}) \times \text{FS}$ ^{*2}	

Voltage accuracy(loop:slow) ^{*1}		$\pm 0.3\% + (0.3\% + 0.3\% \times Kfreq) \times FS^{*2}$
Temp. coefficient		$\pm (0.04\% \text{ per degree from } 25^{\circ}\text{C})$
Max.Current(3 ϕ)	RMS	96A/48A
	Peak(CF=3)	288A/144A
Total Harmonic Distortion ^{*3}		$\leq 0.5\%$ at 10-500Hz (Resistive Load)
		$\leq 2\%$ at 501-5000Hz (Resistive Load)
Crest Factor		3
Line Regulation		$\leq 0.1\%FS$ (Resistive Load)
Load Regulation		$\leq 0.5\%FS$ (Resistive Load)
Dynamic Response Time		$\leq 200\mu\text{s}$ (Typical)
Meter		
AC voltage	Range	0-300Vac
	Resolution	10mV
	Accuracy	$\pm (0.2\% + 0.2\%FS)$
	Temp. coefficient	$\pm (0.04\% \text{ per degree from } 25^{\circ}\text{C})$
AC current (rms)	Range	0-96Arms
	Resolution	10mA
	Accuracy	$\pm 0.3\% + (0.3\% + 0.2\% \times Kfreq) \times FS^{*2}$
	Temp. coefficient	$\pm (0.04\% \text{ per degree from } 25^{\circ}\text{C})$
AC current (peak)	Range	0-288Apeak
	Resolution	10mA
	Accuracy	$\pm 0.3\% + (0.3\% + 0.2\% \times Kfreq) \times FS^{*2}$
	Temp. coefficient	$\pm (0.04\% \text{ per degree from } 25^{\circ}\text{C})$
Power	Resolution	10mW
	Accuracy	$\pm 0.4\% + (0.4\% + 0.2\% \times Kfreq) \times FS^{*2}$
	Temp. coefficient	$\pm (0.04\% \text{ per degree from } 25^{\circ}\text{C})$
Phase Angle	Range	0-360°
	Resolution	1°
	Accuracy	$\pm 3^{\circ}$ (45-65Hz) ^{*5}
Frequency	Range	10Hz-5KHz
	Resolution	0.1Hz

	Accuracy	$\pm 0.1\% + 0.1\text{Hz}$ (10Hz-999.9Hz)/ $\pm 0.1\% + 1\text{Hz}$ (1KHz-5KHz) ^{*4}
Other		
Protection	OPP,OCP,OTP	
Interface	GPIB,USB,LAN,RS232,CAN	
Dimension(WxHxD)	27u x 3	

*1: Meet the voltage accuracy requirements: Slow loop speed: 10-100Hz; Fast loop speed: 10-5KHz.

*2: FS corresponds to the full range: $V_{rms}=300\text{Vac}$; $I_{rms}=96\text{A}$; $I_{pk}=288\text{A}$; $P=36\text{KVA}$;

*3: The minimum voltage of THD test is 10Vac (Auto mode) and 20Vac (High mode).

The maximum distortion test is carried out by outputting the maximum current to linear load under 125Vac (Auto mode) and 250Vac (300V mode).

*4: The test frequency accuracy should ensure that the minimum voltage is 35Vac.

*5: The test mode is Fast.

*6: The minimum voltage setting must not be less than 50Vdc/35Vac.

*8: The maximum current range is 95% in the parallel mode.

*9: Three power supplies with 12KVA, max. 3 ϕ input current of each power supply is 120A.

Parameter	IT7634	V1.1
AC Input		
Voltage	380Vac $\pm 10\%$ (Y)	
Phase	3 ϕ	
Frequency	47-63Hz	
Max.Current	120A $\times 3$ ^{*9}	
Power Factor	0.7(Typical)	
AC Output		
Output Phase	3 ϕ	
Max. output power	45KVA	
Max.output power of each phase	15KVA	
Voltage range	High:2V-300V, Low:1V-150V, Auto:1V-150V/2V-300V	
Voltage resolution	10mV	
Voltage accuracy(loop:fast) ^{*1}	$\pm 0.2\% + (0.2\% + 0.2\% \times K_{freq}) \times FS$ ^{*2}	

Voltage accuracy(loop:slow) ^{*1}		$\pm 0.3\% + (0.3\% + 0.3\% \times Kfreq) \times FS^{*2}$
Temp. coefficient		$\pm (0.04\% \text{ per degree from } 25^{\circ}\text{C})$
Max.Current(3 ϕ)	RMS	120A/60A
	Peak(CF=3)	360A/180A
Total Harmonic Distortion ^{*3}		$\leq 0.5\%$ at 10-500Hz (Resistive Load)
		$\leq 2\%$ at 501-5000Hz (Resistive Load)
Crest Factor		3
Line Regulation		$\leq 0.1\%FS$ (Resistive Load)
Load Regulation		$\leq 0.5\%FS$ (Resistive Load)
Dynamic Response Time		$\leq 200\mu s$ (Typical)
Meter		
AC voltage	Range	0-300Vac
	Resolution	10mV
	Accuracy	$\pm (0.2\% + 0.2\%FS)$
	Temp. coefficient	$\pm (0.04\% \text{ per degree from } 25^{\circ}\text{C})$
AC current (rms)	Range	0-120Arms
	Resolution	10mA
	Accuracy	$\pm 0.3\% + (0.3\% + 0.2\% \times Kfreq) \times FS^{*2}$
	Temp. coefficient	$\pm (0.04\% \text{ per degree from } 25^{\circ}\text{C})$
AC current (peak)	Range	0-360Apeak
	Resolution	10mA
	Accuracy	$\pm 0.3\% + (0.3\% + 0.2\% \times Kfreq) \times FS^{*2}$
	Temp. coefficient	$\pm (0.04\% \text{ per degree from } 25^{\circ}\text{C})$
Power	Resolution	10mW
	Accuracy	$\pm 0.4\% + (0.4\% + 0.2\% \times Kfreq) \times FS^{*2}$
	Temp. coefficient	$\pm (0.04\% \text{ per degree from } 25^{\circ}\text{C})$
Phase Angle	Range	0-360°
	Resolution	1°
	Accuracy	$\pm 3^{\circ}$ (45-65Hz) ^{*5}
Frequency	Range	10Hz-5KHz
	Resolution	0.1Hz

	Accuracy	$\pm 0.1\% + 0.1\text{Hz}$ (10Hz-999.9Hz)/ $\pm 0.1\% + 1\text{Hz}$ (1KHz-5KHz) ^{*4}
Other		
Protection	OPP,OCP,OTP	
Interface	GPIB,USB,LAN,RS232,CAN	
Dimension(WxHxD)	37u x 3	

*1: Meet the voltage accuracy requirements: Slow loop speed: 10-100Hz; Fast loop speed: 10-5KHz.

*2: FS corresponds to the full range: $V_{rms}=300\text{Vac}$; $I_{rms}=120\text{A}$; $I_{pk}=360\text{A}$; $P=45\text{KVA}$;

*3: The minimum voltage of THD test is 10Vac (Auto mode) and 20Vac (High mode).

The maximum distortion test is carried out by outputting the maximum current to linear load under 125Vac (Auto mode) and 250Vac (300V mode).

*4: The test frequency accuracy should ensure that the minimum voltage is 35Vac.

*5: The test mode is Fast.

*6: The minimum voltage setting must not be less than 50Vdc/35Vac.

*8: The maximum current range is 95% in the parallel mode.

*9: Three power supplies with 18KVA, max. 3 ϕ input current of each power supply is 120A.

Parameter	IT7636	V1.1
AC Input		
Voltage	380Vac $\pm 10\%$ (Y)	
Phase	3 ϕ	
Frequency	47-63Hz	
Max.Current	120A $\times 3$ ^{*9}	
Power Factor	0.7(Typical)	
AC Output		
Output Phase	3 ϕ	
Max. output power	54KVA	
Max.output power of each phase	18KVA	
Voltage range	High:2V-300V, Low:1V-150V, Auto:1V-150V/2V-300V	
Voltage resolution	10mV	
Voltage accuracy(loop:fast) ^{*1}	$\pm 0.2\% + (0.2\% + 0.2\% \times K_{freq}) \times FS$ ^{*2}	

Voltage accuracy(loop:slow) ^{*1}		$\pm 0.3\% + (0.3\% + 0.3\% \times Kfreq) \times FS$ ^{*2}
Temp. coefficient		$\pm (0.04\% \text{ per degree from } 25^\circ\text{C})$
Max.Current(3 ϕ)	RMS	144A/72A
	Peak(CF=3)	432A/216A
Total Harmonic Distortion ^{*3}		$\leq 0.5\%$ at 10-500Hz (Resistive Load)
		$\leq 2\%$ at 501-5000Hz (Resistive Load)
Crest Factor		3
Line Regulation		$\leq 0.1\%FS$ (Resistive Load)
Load Regulation		$\leq 0.5\%FS$ (Resistive Load)
Dynamic Response Time		$\leq 200\mu s$ (Typical)
Meter		
AC voltage	Range	0-300Vac
	Resolution	10mV
	Accuracy	$\pm (0.2\% + 0.2\%FS)$
	Temp. coefficient	$\pm (0.04\% \text{ per degree from } 25^\circ\text{C})$
AC current (rms)	Range	0-144Arms
	Resolution	10mA
	Accuracy	$\pm 0.3\% + (0.3\% + 0.2\% \times Kfreq) \times FS$ ^{*2}
	Temp. coefficient	$\pm (0.04\% \text{ per degree from } 25^\circ\text{C})$
AC current (peak)	Range	0-432Apeak
	Resolution	10mA
	Accuracy	$\pm 0.3\% + (0.3\% + 0.2\% \times Kfreq) \times FS$ ^{*2}
	Temp. coefficient	$\pm (0.04\% \text{ per degree from } 25^\circ\text{C})$
Power	Resolution	10mW
	Accuracy	$\pm 0.4\% + (0.4\% + 0.2\% \times Kfreq) \times FS$ ^{*2}
	Temp. coefficient	$\pm (0.04\% \text{ per degree from } 25^\circ\text{C})$
Phase Angle	Range	0-360°
	Resolution	1°
	Accuracy	$\pm 3^\circ$ (45-65Hz) ^{*5}
Frequency	Range	10Hz-5KHz
	Resolution	0.1Hz

	Accuracy	$\pm 0.1\% + 0.1\text{Hz}$ (10Hz-999.9Hz)/ $\pm 0.1\% + 1\text{Hz}$ (1KHz-5KHz) ^{*4}
Other		
Protection	OPP,OCP,OTP	
Interface	GPIB,USB,LAN,RS232,CAN	
Dimension(WxHxD)	37u x 3	

*1: Meet the voltage accuracy requirements: Slow loop speed: 10-100Hz; Fast loop speed: 10-5KHz.

*2: FS corresponds to the full range: $V_{rms}=300\text{Vac}$; $I_{rms}=144\text{A}$; $I_{pk}=432\text{A}$; $P=54\text{KVA}$;

*3: The minimum voltage of THD test is 10Vac (Auto mode) and 20Vac (High mode).

The maximum distortion test is carried out by outputting the maximum current to linear load under 125Vac (Auto mode) and 250Vac (300V mode).

*4: The test frequency accuracy should ensure that the minimum voltage is 35Vac.

*5: The test mode is Fast.

*6: The minimum voltage setting must not be less than 50Vdc/35Vac.

*8: The maximum current range is 95% in the parallel mode.

*9: Three power supplies with 18KVA, max. 3 ϕ input current of each power supply is 120A.

9.2 Supplemental characteristics

State storage capacity: 10sets

Recommended calibration frequency: once a year

Cooling style: fans

Chapter10 Remote Control

IT7600 have five standard communication interfaces: LAN, USB, RS232, GPIB and CAN. The customer can choose any one according to his demands.

10.1 RS232 Interface

There is a DB9 connector at the rear of the power supply, when connecting to computer, you need to select a cable with COM port on both side; To active you need to press **[Shift] + [Setup]** (Menu) button to enter the menu item Communication Configure to set the relevant parameters, which is same with the PC communication configuration. You could do the secondary development with all SCPI commands.



Note

The setup about RS232 in the program should agree with the configuration in the system set. If you want to change the communication parameters, please press **[Shift] + [Setup]** (Menu) button to enter the system set.

RS-232 Data style

RS232 data includes start bit, parity bit, data bit and stop bit. The number of start bits can not be edited. The stop bit can choose 1 or 2. You can select the parity and stop bits via the front panel **[Shift] + [Setup]** (Menu) keys.

Baudrate

The front panel **[Shift] + [Setup]** (Menu) button allows the user to set baud rate which is stored in the non-volatile memory: 4800/9600/19200/38400 /57600/115200.

RS-232 connection

Adopt the RS232 cable with DB-9 interface because the serial port of RS232 can be connected with that of the controller (e.g. PC). The modulating cable of the air-conditioner is not recommended. The pins of plug are shown as the following table.

If your computer is provided with a RS232 interface with DB-25 plug, a cable and a adapter with DB-25 plug (one end) and DB-9 plug (the other end) are required (not the modulating cable of the air-conditioner).



Pin	description
1	connectionless
2	TXD, transmit data
3	RXD, receive data
4	connectionless
5	GND, ground
6	connectionless
7	CTS, clear transfer
8	RTS, ready to transfer
9	connectionless

RS-232 Troubleshooting

In case of connection failure of RS232, perform following check:

- Check if the computer and power supply are provided with same Baud rate, parity check bit, data bit and flow control. The power supply shall be configured with one start bit (fixed) and one or two stop bits.
- Just as described in the RS232 connector, appropriate interface cable or adapter shall be adopted. Notes: even if the cable is equipped with right plug, internal wiring may be incorrect.
- The interface cable must be connected to the right serial port (COM1 and COM2) of the computer.

Communication Setup

Before the communication operation, please ensure the PC match the power supply to the PC's parameters in following items

baudrate: 9600(4800, 9600, 19200, 38400, 57600, 115200). You could enter the system menu to set the baudrate.

Data bit: 8

Stop bit: 1

Parity bit: (none, even, odd)

EVEN **8 data bits have even parity**

ODD **8 data bits have odd parity**

NONE **8 data bits have no parity**

Native machine address: (0 ~31, factory default is 0)

Start Bit	8 Data Bits	Parity=None	Stop Bit
-----------	-------------	-------------	----------

10.2 USB Interface

Use a cable with two USB ports to connect power supply and PC. You can program through USB interface to achieve all functions of power supply.

The functions of USB488 interface are as follows:

Interface is 488.2 USB488 interface

Receive the following request: REN_CONTROL, GO_TO_LOCAL, and LOCAL_LOCKOUT

When the interface receives MsgID = TRIGGER USBTMC command, it will transmit the TRIGGER command to the function layer

The functions of power supply's USB488 are as follows:

receive all SCPI commands

device is SR1 enabled

device is RL1 enabled

device is DT1 enabled

10.3 LAN Interface

Press **[Shift] + [Setup]** (Menu) on the front panel together to access the menu. Select LAN in the Communication Configure from System and then configure Gateway, IP and Mask in the LAN option.

Connect the LAN interface of power supply to the computer with a reticle (crossed).

10.4 GPIB Interface

First connect GPIB interface to GPIB card of PC with IEEE488 BUS. They must be sufficient contact and tighten the screws. Then set the address within 1 to 30. Press **[Shift] + [Setup]** (Menu) on the front panel. Then press "Communication Configure" and set "Current Comm" as GPIB. Set the GPIB Address and press **[Enter]**. The power supply operates by setting the GPIB address on the front panel. The GPIB address is stored in non-volatile memory.

10.5 CAN Communication Port

There is one DB25 interface at the rear panel, and the pin definition is shown below. The user can use this terminal for PC connection; to activate connection, be sure that the values set in the System menu are same as the corresponding values set in PC.



Note

CAN setting in the program shall be consistent with the one set in the System menu of front panel. To query and change, press the composite key **[Shift] + [Setup]**(Menu) to enter the setting screen in System menu for query and change. For details, refer to 3.10 Menu Operation.

Baud Rate

Under the Communication Configure menu of the front panel **[Shift] + [Setup]** (Menu), the user can set such parameters as Baudrate Prescaler, Propagation Time Segment and Phase Buffer Segment. Based on calculation conditions and formulas given by the interface, obtain specific Baud Rate value.

The interface provides conditions and formulas:

The Clock of CAN is 42MHz.

$$\text{Baudrate} = 42\text{MHz} / \text{Prescaler} / (\text{BS1} + \text{BS2} + 1)$$

Examples for specific calculation method of baud rate are given below:

Set Prescaler=6, Bit segment1=5 and Bit segment2=8. According to the calculation formula:

$$\text{Baudrate} = 42\text{MHz} / 6 / (5 + 8 + 1) = 500\text{K}, \text{ the Baud Rate is } 500\text{K}.$$

CAN Pin Definition

Use DB25 interface for connection. CAN interface pin is as follows.

CAN interface pin

Pin No.	Description
1	CANH
14	CANL

CAN Troubleshooting:

If CAN connection fails, check that:

1. The PC and power supply have same Baud rate.
2. Appropriate interface pin or adapter is used, as described in CAN

connector.

3. The interface cable is correctly connected (CAN_H to CAN_H, CAN_L to CAN_L).

Setting Communication

Before communication operation, match the power supply with the following PC parameters.

Prescale (Pres): Set this parameter as needed

PTS (BS1): Set this parameter as needed

PBS (BS2): Set this parameter as needed

Calculate the Baud Rate according to the above three parameters.

ID (Can ID): Set Can Port ID based on computer.

Appendix

Specifications of Red and Black Test Lines

ITECH provides you with optional red and black test lines, the user can choose the company's test line for testing. For specifications of ITECH test lines and maximum current values, refer to the table below.

Model	Specifications	Length	Description
IT-E30110-AB	10A	1m	Alligator clips-Banana plugs A pair of red and black test line
IT-E30110-BB	10A	1m	Banana plugs - Banana plugs A pair of red and black test line
IT-E30110-BY	10A	1m	Banana plugs - Y-type terminals A pair of red and black test line
IT-E30312-YY	30A	1.2m	Y-type terminals - A pair of red and black test line
IT-E30320-YY	30A	2m	Y-type terminals - A pair of red and black test line
IT-E30615-OO	60A	1.5m	Ring terminals - A pair of red and black test line
IT-E31220-OO	120A	2m	Ring terminals - A pair of red and black test line
IT-E32410-OO	240A	1m	Ring terminals - A pair of red and black test line
IT-E32420-OO	240A	2m	Ring terminals - A pair of red and black test line
IT-E33620-OO	360A	2m	Ring terminals - A pair of red and black test line

For maximum current of AWG copper wire, refer to table below.

AWG	10	12	14	16	18	20	22	24	26	28
The Maximum current value(A)	40	25	20	13	10	7	5	3.5	2.5	1.7

Note: AWG (American Wire Gauge), it means X wire (marked on the wire). The table above lists current capacity of single wire at working temperature of 30°C. For reference only.

Contact US

Thank you for purchasing ITECH products. If you have any doubt about this product, please contact us as follow.

1. Please refer to the CD-ROM of related user's manual in package.
2. Visit ITECH website www.itechate.com.
3. Select the most convenient contact for further consultation.