

QxL & QxP

Advanced Rasterizer and Waveform Monitor for Hybrid IP/SDI, 4K/UHD, HDR/WCG Generation, Analysis and Monitoring

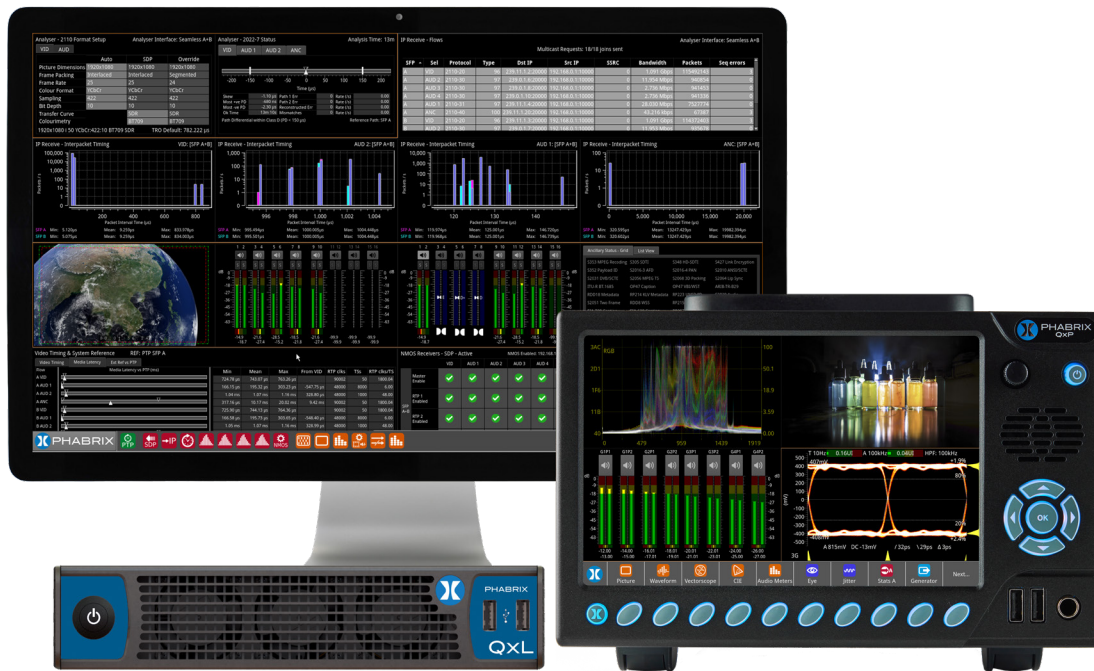

Qx Series - Technology to power change



From the moment you first power up a Qx Series instrument, you'll appreciate the attention to detail in a platform designed to meet the increasing demands of monitoring and testing in SDI/IP hybrid environments. The Qx Series is equally at home in master control rooms, OB and link trucks, production studios, technical QC, product development, engineering compliance testing and operational system monitoring. Whether you are working in SD*, HD or UHD, SDR or HDR, SDI or IP, conventional or remote production, Qx rasterizers and waveform monitors bring together the user-configurability and advanced tools required for full operational flexibility when transitioning to your next generation workflows.

Available in three platforms, with a common look and feel, the Qx Series provides an intuitive user interface and toolsets that help with rapid fault diagnosis and reduce the need for staff training. The comprehensive feature set supports SD*/HD/3G/6G/12G-SDI, 10G/25G IP interfaces, and SD*/HD/UHD, IP SMPTE 2022-6, SMPTE 2110-10/20/30/31/40 (ST 2110-20 RGB payloads up to 21Gbps) with ST 2022-7, PCAP, Dolby E Decode and AMWA NMOS, easing system design and future-proofing your investment.

Analyzer/Generator - Simultaneous operation

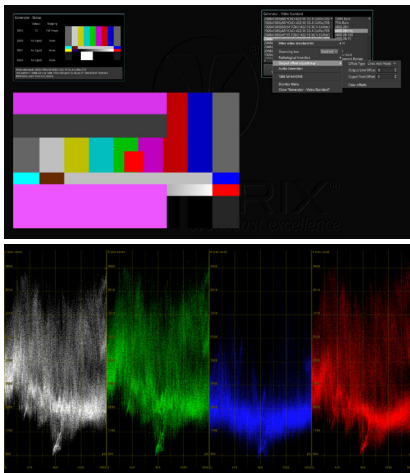

The QxL and QxP provide simultaneous Generation and Analysis for a wide range of ST 2110-20/30/31/40, 2022-6 and SD*/HD/3G/6G/12G-SDI formats with support for up to 80 channels of 48 kHz Class C audio in 2110-30/31 and up to 128 channels over 12G SDI.

Configuration can be either Manual, or under REST API control enabling automated closed-loop testing for Engineering regression and manufacturing. ST 2110 Generation and Analysis is also NMOS enabled for ease of integration into IP based systems.

With a full suite of SDR Rec. BT 709/2020, plus native and mapped Wide Colour Gamut (WCG) HDR patterns in HLG, PQ, S-Log3 and SR-Live formats, you are equipped for flexible broadcast SDR and HDR operation.

Generator and Analyzer video format, colorimetry and transfer function can all be configured independently. You have the flexibility to send out an EUHD Rec BT.2100 HDR 12 bit RGB pattern with Class C audio and PTP locked Timecode and analyze the down-converted, down-mapped HD SDR Rec 709 return simultaneously.

Compliance - it's all about Test and Measurement

Developing products or commissioning the latest equipment is more than just implementation. Equipment has to be tested against the required standards for it to be considered fit for purpose.

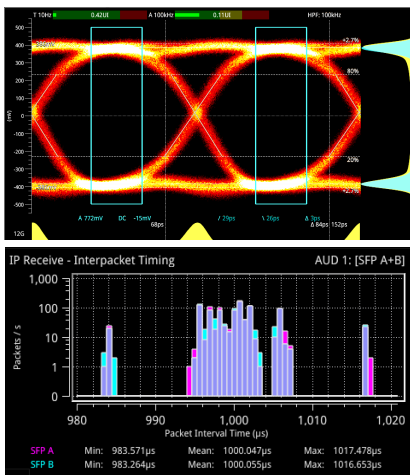

In the 12G-SDI world, noise floors are required to be much lower to ensure that accurate and meaningful measurements can be taken. Qx SDI generation and measurement technology has been specifically adapted for 12G applications. With its unique class leading SDI-STRESS toolset, sophisticated RTE™ (Real-Time Eye) multi-rate physical layer display, and automated SMPTE compliance measurements, the Qx Series offers a single product solution for SDI compliance verification.

If IP working in SMPTE ST 2110, with ST 2059 Precision Time Protocol (PTP), a core IP toolset, available in both the QxL and QxP offers an operator all of the IP confidence status monitoring in an intuitive and accessible manner. The optional IP-MEAS test suite provides a comprehensive set of tools for compliance verification and commissioning of your IP systems and equipment.

Hardware-based timestamping locked to PTP ensures accurate, realtime, deterministic timing measurements of media flows and ST 2110-21 buffer models.

Applications

Outside Broadcast



NEP UK selected Qx rasterizers for two of its new OB trucks, for use at major events and sporting fixtures. Hybrid SDI/IP capability was a key selling point for NEP enabling them to accommodate clients whether they are using conventional SDI or have made the move to IP. The ease of use of the Qx was also a major factor, making it quick and simple for both NEP engineering staff and freelancers to learn and use.

Engineering and Technical Director, NEP UK, said, "We've been very happy with the reliability of PHABRIX test and measurement equipment in the past, so it was an obvious fit to look at the Qx for these new IP-capable vehicles."

Sports and Live Events



PHABRIX recently concluded nine months of successful HDR technology trials with BT Sport in the run-up to the launch of BT Sport Ultimate. The Qx is now deployed to monitor and analyze SDR and HDR Wide Color Gamut (WCG) material on the live system. PHABRIX supported BT Sport, providing its Qx rasterizers and technical expertise, as they developed and refined their live production workflow for the launch of their new HDR, UHD and Dolby Atmos® supported proposition. On the bench PHABRIX collaborated with BT Sport to analyze and provide suggested settings for SDR to HDR converters and 'tone mappers' used in the trucks and throughout the network.

Manufacturing & Compliance Testing



Mellanox Rivermax® development and regression testing teams have been using the QxL to provide simultaneous analysis of the SMPTE ST 2110 Video, Audio and ANC DATA flows from their Rivermax® video streaming library for media and entertainment, running on Mellanox ConectX-5 and newer, Network Interface Cards," said Nir Nitzani, senior director SW development at Mellanox Technologies.

"The ability to install the QxL in the machine room and remotely access and control the realtime measurements from several sites has been an ideal fit with our engineering development workflow."

Extended Reality (XR)

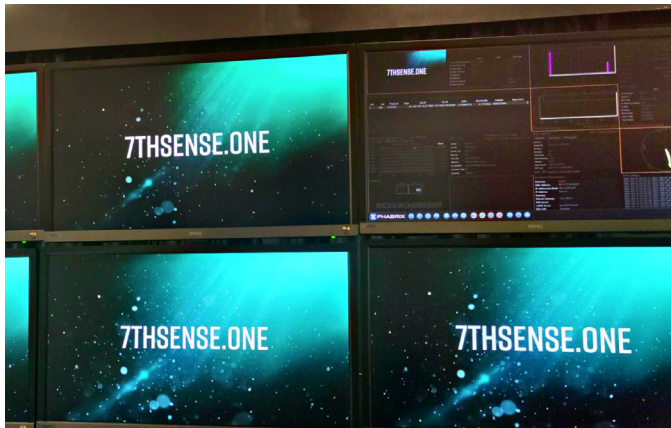

7thSense chose a PHABRIX QxL 25G IP ST 2110 rasterizer for SDI and advanced IP 2110 product verification in-house, and at onsite installations. PHABRIX and 7thSense joined forces to develop the capability to output the next generation of ST 2110 IP formats, including UHD/4K 12 bit 444 60p.

Richard Brown, CTO, 7thSense, said, "As we begin delivering SMPTE 2110 support from our Delta Media Server and Juggler pixel processor products, we needed to ensure all of our solutions comply to the required specifications. We needed test and measurement technology that we could rely on, was robust, and supported the wide variety of formats we need to test."

Platforms to suit every workflow

The flexible architecture of the QxL and QxP offers many engineering grade tools as standard, together with in-field optional upgrades for UHD/4K, 2110-20 EUHD (RGB UHD/4K 48-60p), PCAP, Dolby E Decode, HDR, and Audio/Video/ANC test signal generation. A factory-fitted hardware option provides RTE™ realtime SDI eye and jitter analysis with the further option of a highly advanced SDI-STRESS toolset.

PHABRIX QxL - 10/25GbE / 12G-SDI

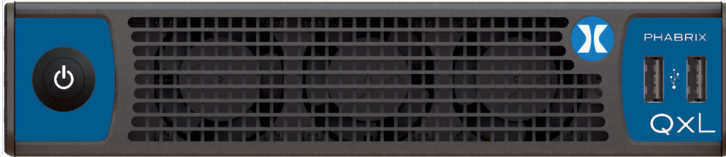

For realtime UHD IP workflows on 25G networks with video payloads up to 21 Gbps, the class-leading QxL provides support for ST 2110 and 2022-6 on generic 10G/25G SFP28 interfaces. The QxL is 10G IP-enabled as standard, with support for simultaneous generation and analysis of a JT-NM TR 1001-1:2020, ST 2110-20 (video), up to four 2110-30 (PCM) and 2110-31 (AES transport) audio and a 2110-40 ANC media flow, all with 2022-7 Seamless IP Protection Switching (SIPS) and AMWA NMOS IS-04 discovery and IS-05 device connection management.

Independent PTP slaves on both media ports are provided for fully-redundant media network operation with AMWA NMOS IS-04 discovery and IS-05 device connection management. The option of HDR, PCAP, Dolby E Decode and IP-MEAS in-field license upgrades means that you can tailor your system to your current needs while retaining full flexibility for the future.

Support for 25G IP, UHD/4K formats for both IP and SDI, including some HD/2K extended mode formats, PCAP, IP Measure, and UHD 2110 Extended Mode formats (YCbCr/RGB 444, 8-/10-/12-bit; 48 to 60 Hz), can also be added as optional licenses (for the full list of UHD and EUHD standards supported, please see pages 27 - 28).

SDI BNC and SFP media interfaces are available as a factory-fitted option. The SDI Eye and Jitter hardware option and the unique SDI-STRESS toolset provide all the tools for SDI physical layer analysis and compliance testing.

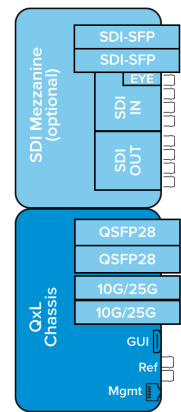
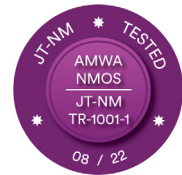

PHABRIX QxP - 10/25GbE / 12G-SDI



Introducing the latest member of the Qx test and measurement family - the QxP, the world's first portable, 12G-SDI, 25G ST 2110, combined waveform monitor, generator and analyzer, with mains and external DC power and a choice of V-mount or Gold mount (G-mount) external camera battery plate. This provides all of the functionality of the QxL in a handy, lightweight, portable 3RU chassis with an integral 1920 x 1200 7 inch LCD multi-touch screen. If you prefer buttons or mouse control then you are free to use any combinations of controls.

You can run all QxL instruments on the integral screen with minimal retraining. Plug in an external HDMI monitor and you have the same experience as if you were using the QxP as a conventional Rasterizer.

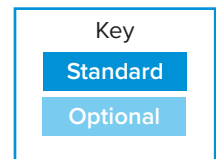

*JT-NM Tested - For more details on the JT-NM Tested Program (Spring 2020) and its test results, please see: http://jt-nm.org/jt-nm_tested/

Simplicity - an interface that puts you in control

The Qx's innovative app style interface is a radical change from traditional test and measurement systems. Intuitive mouse control with context-driven dropdown menus hides the complexity of modern SDI and IP systems providing an uncluttered view of critical information. Instruments can be resized, the system auto-presenting more information as the screen area permits.

The Qx offers a fully flexible user-defined instrument layout, displaying up to 16 instruments on a single 1920 x 1080 display. Individual instruments can switch between 1/16th, 1/4 or full screen. With an output frame rate of 50, 50.94 or 60 Hz to match the video format, the GUI has adjustable brightness for controlled lighting environments.

Instrument Tabs

- Tabs along the top of a window provide quick access to different functional groups within a single instrument

Instrument Tooltips

- The UI displays context-driven tooltips providing additional information when hovering over parameters

Instrument Navigation

- Each instrument includes a pop-up submenu, giving you access to the configuration parameters of that instrument

The screenshot shows a complex interface with multiple panels. At the top left, there's a 'Generate - Video' and 'Audio' tabbed menu. Below it is a table of video resolutions. The main area contains several instrument panels: a signal list, an active picture line viewer, a waveform viewer, and a signal analyzer. A tooltip points to a specific pixel and sample. A 'Safe Areas' menu is open on the right. At the bottom, there's a 'PHABRIX' logo and various system icons.

Take Screenshot

Dismiss Menu

Screen Capture

- SFTP and Browser network access to event logs, screenshots, user presets

Event Logging

Qx Network & Automation

PHABRIX

Instrument Launch Menu

- Provides access to the instruments and other system menus available on the unit
- Each Instrument available in the menu is listed alongside a designated icon

New Preset
Channel 1
Tx 2
MCR

Presets

- Save multiple display layouts as presets and update as required
- Save bespoke layouts for different operational tasks
- Use to change rapidly between different screen layouts eg. Audio, HDR or IP focus

Brightness 8

Gamma 124

Numeric Slider & Scroll Bar

- Adjust numeric values by dragging or scrolling the slider button
- Mouse over the numeric field and scroll for fine control
- Connect to USB keyboard, click and enter specific alpha numeric values

Time Zone: Time/Date: Update Now

Automatic

NTP Server: pool.ntp.org

Last Update: 20 Dec 2018 12:48:03

Moscow Paris

Network Time Protocol

- Configure the unit to use a date and time transmitted by a target Network Time Protocol (NTP) server or set the time and date manually in the Time and Date dialog.

V-Err	0	0	0	0
ANC-Err	5	5	5	5
Rate (/s)	0.013	0.013	0.013	0.013

Error Highlighting

- Errors are displayed in red font

QxP Touchscreen - control at your fingertips

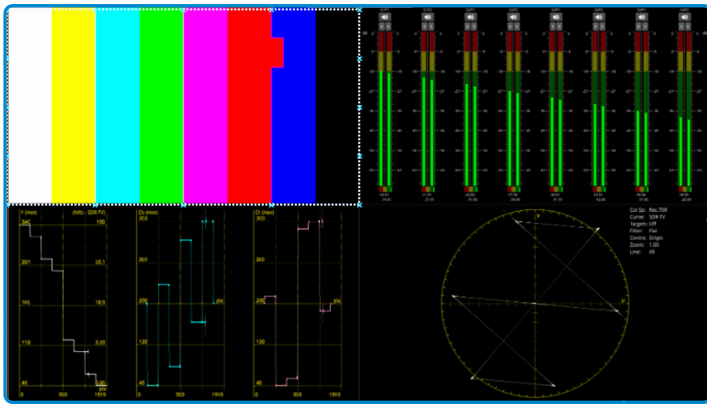

Instrument Area

- Display up to 16 Instruments Simultaneously
- Touch-sensitive Controls
- Open Each Instrument at Default 1/4 Screen Size
- Tooltips at a touch

Context-sensitive menus

- Instrument-specific, Context-sensitive Menus
- Easy Access to Configurable Parameters

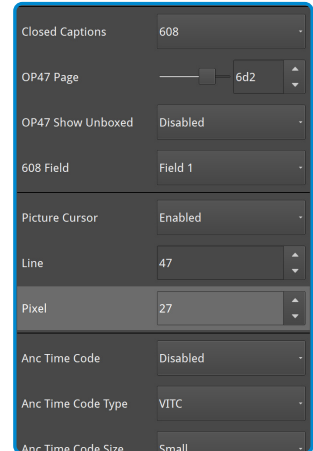

Rotary Control

- Move Cursor Focus Between Instruments
- Navigate & Select from Context-sensitive Menus
- Press for OK

PHABRIX Key

- Display Instrument Launch Menu
- Press Repeatedly to Return to Default Function Bar



PHABRIX Button

- Display Instrument Launch Menu
- Press Repeatedly to Return to Default Function Bar

Function Bar

- 10 Context-specific Function Softkeys
- Access Configuration Menus of Active Instruments

Function Buttons

- 10 Physical Function Button Controls
- Correspond Directly to the Context-specific Function Softkeys Above



On/Off

Speaker

Cursor Control Buttons

2x USB Ports

Headphone Socket

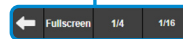

Submenus

- Frequently-used Button Banks
- Rapid Access to Favorites, Presets & System



Introducing our new waveforms

PHABRIX is pleased to announce the development of class-leading Waveform Monitoring for the Qx Series of Rasterizers and Waveform Monitors. Utilizing a technique patented by PHABRIX to efficiently deliver a high-resolution image processing pipeline with support for deep color sources up to 12-bits, this instrumentation delivers all the fine detail required for Camera Shading, Image Grading or critical QC of both SDR and HDR content.

A choice of Overlay, Stacked and Parade display modes are provided each with the option of multi-colored, highlighted, green or monochrome traces. The flexibility to display YCbCr, RGB, YRGB and individual components is retained along with connected instrument cursor linked to Picture and Data view, and user markers linked to Vectorscope. Single Line Mode and H and V magnification are available for detailed inspection.

Luminance Nits scales and operation user-controlled Nits markers are provided for SDR, HLG, PQ, S-Log3, SR-live HDR formats. Both SMPTE-narrow and full-range operation are supported along with matrices for 709, 2020 and DCI P3 over the wide-range of YCbCr:422, RGB:444, SDI, 2110, SD*/HD/2K/UHD/4K/EUHD formats for which PHABRIX is famous.

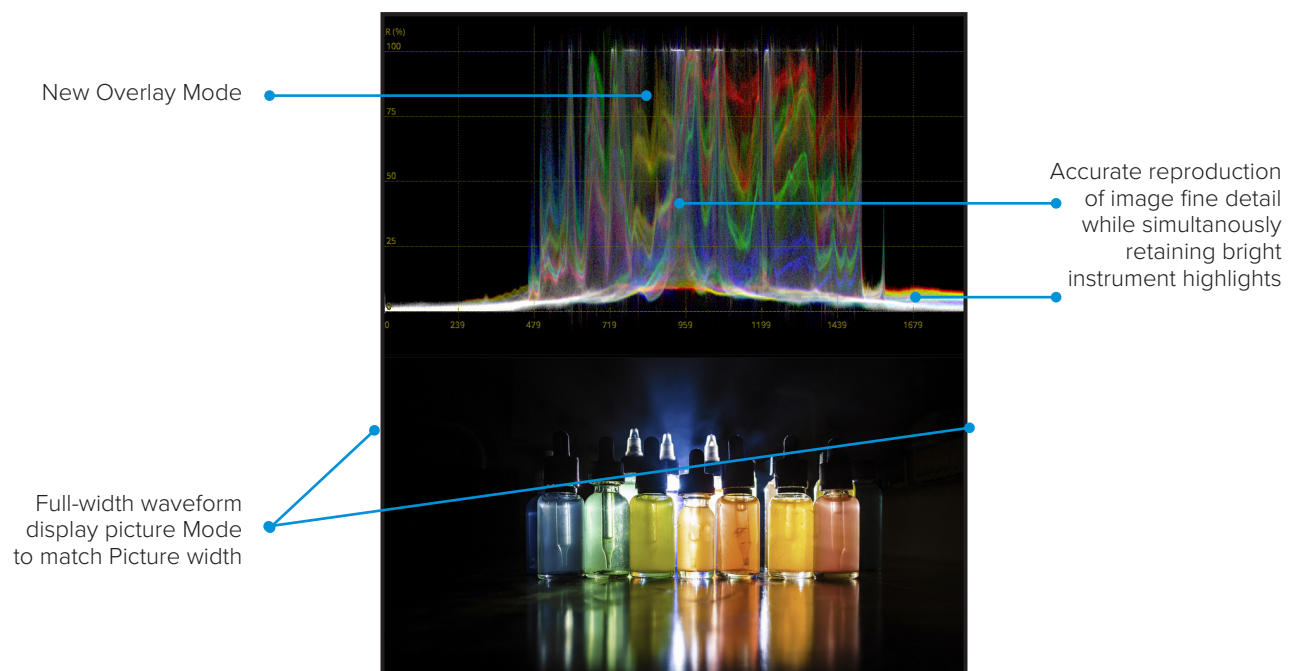

Overlay RGB (Color)

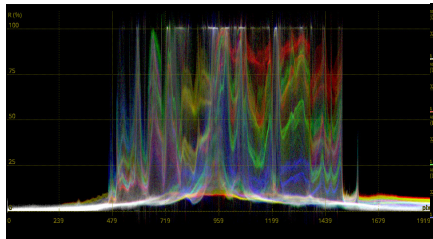

Stacked YRGB (Color)

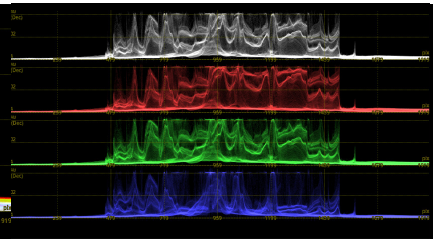

Parade YCbCr (Color)

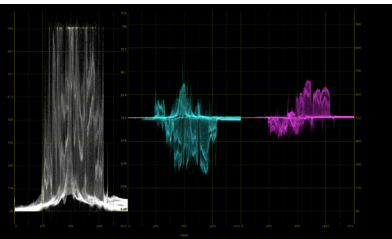

YRGB Parade (Color Highlight)

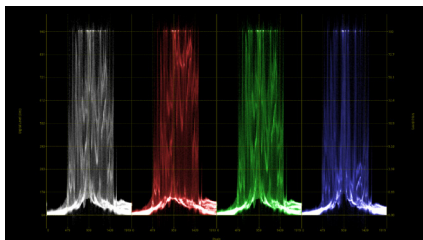

YRGB Parade (Green)

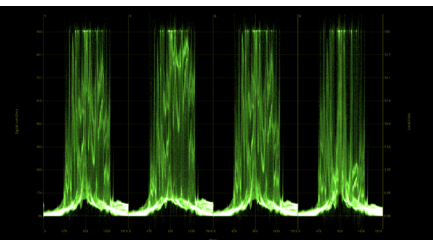

YCbCr Parade (Monochrome)

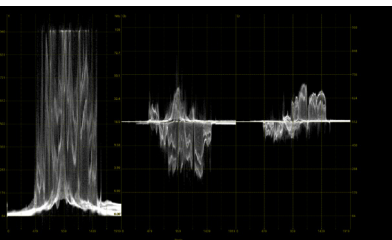

Standard Toolset



As standard, the Qx Series offers a flexible user-defined instrument layout displaying up to 16 simultaneous windows, and the ability to change rapidly between bespoke layouts for different operational tasks with user presets.

Picture view, waveform monitor, vectorscope, 32 channel audio metering, decoded audio channel status information, detection of common Dolby formats, ANC status and payload, on screen display of OP47 and CEA-608 in 708 closed captions and Ancillary Time Code (ATC), Loudness monitoring, and advanced control and logging with human readable event logs, remote operator GUI access over noVNC and a full REST API are all provided as standard.



Picture Display

- Cursors linked to Waveform and Data View
- Action, graphics and user-definable custom safe areas
- 1/16, 1/4 or full size display

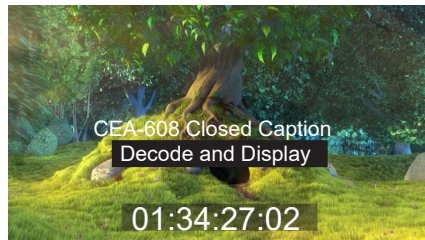

Auxiliary Data Decode

- Closed Captions OP47, CEA-608 in 708
- Primary Closed Caption decode picture window
- ANC Timecode with OSD
- Date, V-chip, AFD and Input name
- SCTE 104 indication and logging



Analyzer - Picture Copy

- Secondary closed caption decode: Monitor 608/708 closed captions in a second language, or compare different screen safe areas
- Independently manage overlay elements including; Closed Captions, Picture Safe Areas, V-chip, AFD, SCTE 104, Image Center Crosshairs

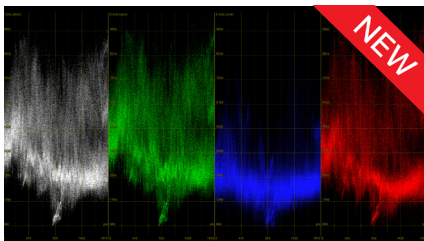

Analyzer - Waveform

- YCbCr, YGBR and GBR display modes
- Cursor linked to Picture and Data View
- Single line mode linked to Picture Cursor
- Configurable H and V Graticules
- User markers
- Overlay, Stacked, Parade, Single line, H & V Mag, Brightness, Persistence and Monochrome controls
- 12-bit processing

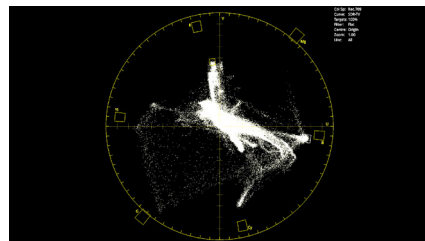

Analyzer - Vectorscope

- 75% and 100% Targets for ITU-R Rec. 709, Rec. 2020 and HDR formats
- Custom 'user markers' linked to Waveform
- Center on target or custom user markers
- 0.5x to 4x Mag, center on chosen target
- Single line mode linked to Picture Cursor
- Tooltip display of Cb, Cr and Hue Angle
- IQ axis on/off
- 12-bit processing

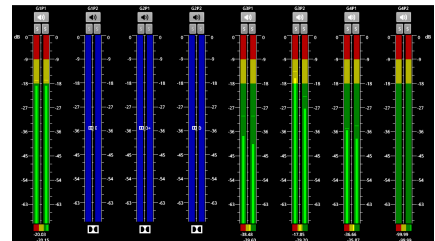

Analyzer - Audio Meters

- Two meter windows can be opened, each monitoring a block of up to 16 channels at a time, for a total of up to 32 channels of audio metering
- 2110 audio group display across up to 4 flows
- Ballistics: PPM-I, PPM-II, Vu, Vu-Fr, Fast
- Scales: dBFS, dBu -18, dBu -20, BBC, DIN45406, NordiCn9
- Adjustable peak hold times: Off, 0.1 s to Inf
- Audio pair correlation meters, numerical level
- Detection of Dolby E, ED2, DD, DD+, DE line pos
- Stereo/mono audio preview bus

Analyzer - Audio Channel Status						Meters 1 + 2 Flows			
Presence	Audio 2 Ch1-16: PPEE++DDPPPPPPPP				Audio 1 Ch1-16: PPPPPPPPPPP				
	Aud2Ch01	Aud2Ch02	Aud2Ch03	Aud2Ch04	Aud2Ch05				
Status	CRCC Ok	CRCC Ok	CRCC Ok	CRCC Ok	CRCC Ok				
Use	Pro	Pro	Pro	Pro	Pro				
Data	PCM	PCM	PCM	PCM	PCM				
Emphasis	None	None	None	None	None				
Source Lock	Locked	Locked	Locked	Locked	Locked				
Frequency	48	48	48	48	48				
Chan Mode	2 Channel	2 Channel	2 Channel	2 Channel	2 Channel				

Audio Status

- 32 channel indication of audio type and presence, PCM, Dolby E, DD, DD+, ED2
- Decoded channel status information for up to 128 channels
- Clear indication of useful audio parameters including CRCC, PCM/data, sample frequency, word length
- Channel Status data view (Hex)

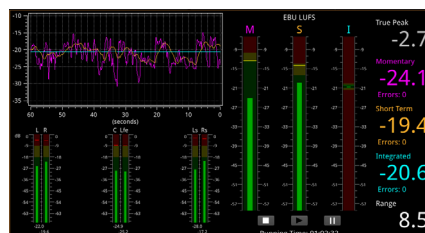

Loudness Monitoring

- EBU R128 and ITU-R BS.1770
- Indicators for true peak, range, momentary, short term and integrated loudness
- User control of integrated, momentary and short term targets
- User-adjustable true peak alarm threshold
- Loudness logging stored automatically

S353 MPEG Recoding	S395 SDTI	S348 HD-SDTI	S427 Link Encryption	S382 Payload ID
S2016-1 AFD	S2016-4 PAN	S2010 ANDESCTE	S2031 DVBI/SCTE	S2004 MPEG TS
S3068 SDI Packing	S2064 LIP Sync	ITU-R B.1681	0943 Caption	0943 WBWST
ABRFR-820	RDD18 Metadata	RP214 KLV Metadata	RP223 LMD/ID	S2020 Audio
S2051 Two Frame	RDD18 WSS	RP215 Film Codes	S1242-2 VTCODE	EJA-708 Caption
EIA-608 Caption	RP207 Program	S334-1 Data	RP208 VBI Data	Mark Deleted
S299-2 3G Audio	S299-1 HD Audio	S272 SD Audio	S315 Camera Pos	RP165 EDH

Analyzer - Ancillary Status

- SMPTE ST 291 VANC/HANC ancillary data presence/status window
- Grid View – clear visual overview, present/absent/fault indication
- List View – ANC present list with location and status information for Checksum, Parity, DBN
- Link to ANC Inspector
- Tooltip provides ST 291 ANC type overview

Standard Toolset



Data View Analyzer with ANC Inspector

The engineering grade Data View Analyzer and ANC Inspector tools provide easy, accessible visualization of the data on an SDI interface and associated ANC packets. Deep SDI data inspection with full freedom to inspect Active Picture, VANC, HANC and API controls to read back Active Picture Data under automation control is included. Also featured is ANC packet decapsulation and error reporting for detailed analysis and debug of ANC payloads.

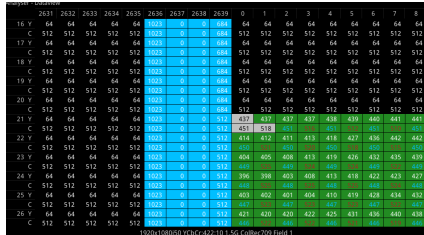

Analysier - Ancillary Inspector

Identifier	S352 Payload ID (4th 01h)	Trigger Type	Single Shot
Range	All Lines	Location	Sub Image 1
Found at location: Sub Image 1 C-Pos Line 10			
000 3FF 3FF 241 101 104 1CE 2C9 180 101			
Data		Value	
Version ID	1h	1	
Payload Identifier	89h	ST 2082-10 2160 Line 12Gbs	
Picture Rate	9h	50	
Progressive Picture	1h	True	
Progressive Transport	1h	True	
Sampling Structure	0h	4:2:2 (Y/Cb/Cr)	
Image Aspect Ratio	0h	16:9	

Analyzer - Data View

- Allows analysis of complex faults
- Detailed view of data words in the SDI stream with tooltip hint
- Navigate function for rapid access to a required line, pixel or TRS word
- Color-coding to help identification
- Cursor linked to Picture and Waveform

ANC Inspector

- Ancillary data packet analyzer
- Link from ANC Status window
- User-defined DID/SDID windowed search
- Trigger on error, single shot, continuous
- ANC packet capture with Hex view
- ANC packet decode view

I/O and Reference Configuration

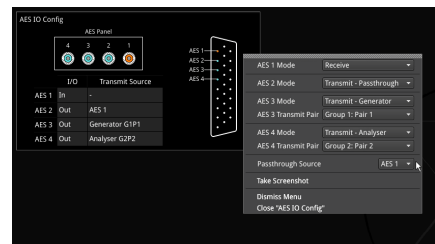
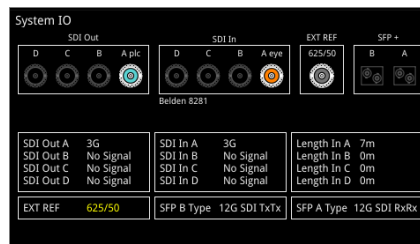
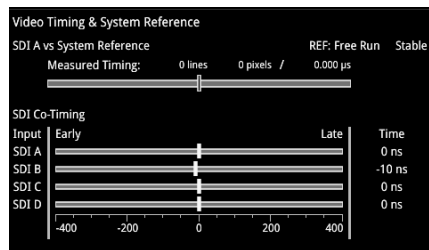

Video Timing & System Reference (2022-6/SDI*)

- Measurement of the timing of inputs against reference
- Indication of reference status and stability
- Indication of the relative co-timing of input SDI channels
- Graphical and numeric display

System IO

- Shows the status of signal inputs and outputs, external reference, cable length, and connector details
- SDI mode: Select BNC or SFP I/O, cable type, loop through and generator copy outputs
- IP mode: Active IP SFP receive inputs and transmit outputs are indicated

AES IO Config

- Four versatile bi-directional AES unbalanced interfaces
- Audio meter monitoring pair, generator audio output or AES input
- SDI Input to AES Output de-embedder for both PCM and Dolby encoded audio
- Route AES Input signals to other AES outputs providing up to three copy outputs



Analysier - CRC Analysis

Analysis time: 2h 58m
Input Failures: 257
Last Failure Time: 11m 6s

	Sub 1	Sub 2	Sub 3	Sub 4
C-CRC-Err	0	0	0	0
Y-CRC-Err	0	0	0	0
ANC-CS-Err	1	0	0	0
Rate (/s)	0.002	0.000	0.000	0.000
OK Time	9m 53s	11m 6s	11m 6s	11m 6s
Active Picture Changes	0	0	0	0
Active Picture CRC	EC9D CAC0	FE4F 7821	EC9D CAC0	FE4F 7821

Stats - SDI In A

Data Rate: 11.880000 GHz
Clock Divisor: 1.000
Cable Length: <20m

	Sub Image 1	Sub Image 2	Sub Image 3	Sub Image 4
Counters Stable	true	true	true	true
Active Samples Per Line	1920	1920	1920	1920
Active Lines Per Field	1080	1080	1080	1080
Total Samples Per Line	2640	2640	2640	2640
Total Lines Frame/Field1	1125	1125	1125	1125
Total Lines Field2	progressive	progressive	progressive	progressive
Payload ID Y-Pos	CE C9 80 01	CE C9 80 01	CE C9 80 01	CE C9 80 01
Payload ID C-Pos	CE C9 80 01	CE C9 80 01	CE C9 80 01	CE C9 80 01

Analyzer - Video Standard (2022-6/SDI*)

- Display of detected SMPTE 352 Payload ID for each SDI Link and Subframe
- Manual override of S352 ID
- Selection of SMPTE video format
- Indication of S352 errors

CRC Analysis (2022-6/SDI*)

- Check for CRC errors on Y, C and ANC
- Reporting of the number of SDI input failures, the last failure time, total analysis time and error rates
- Detect active picture changes and view the active picture CRC to observe any changes in the expected active picture CRC value
- SDI switch line CRC masking control, for SMPTE RP168 compliance checking

Stats - SDI In (2022-6/SDI*)

- Cable length indication
- Indication of data rate and clock divisor
- Reporting of active and total pixel and line counts
- Y and C payload ID

* Available with SDI and PHQXL01-3G / PHQXP01-3G or PHQXL01E-3G / PHQXP01E-3G



Standard Toolset

ST 2110 and ST 2022-6 Monitoring

The core IP feature set, provided as standard in the QxL and QxP, offers an operator all of the ST 2110 confidence status monitoring in an intuitive and accessible manner.

The toolset supports simultaneous decapsulation of one video, four audio and one ANC Data flows. Supported SMPTE protocols include ST 2059 (PTP) ST 2110-20 (Uncompressed Video), -30 (PCM Digital Audio), -31 (AES3 Transparent Transport) and -40 (ANC Data). ST 2022-7 seamless protection (SIPS) with AMWA NMOS IS-04, IS-05 and PTP system resource, is provided over two media network interfaces using industry standard optical ethernet SFPs. Audio handling conforms to ST 2110-30 Class C with support for 48 kHz streams from 1 to 10 channels at packet times of 1 ms and 1 to 80 channels at packet times of 125 μs.

Also provides an indication of the timing relationship of each of the eight ST 2022-7 flows to PTP with status information, as well as a ST 2022-7 status tool that reports the health and relative timing skew of each ST 2022-7 pair, all with hardware time stamping.

SMPTE 2110 & 2022-6

SFP IP Network		IGMP: Max V3	
		SFP E	SFP F
Carrier Signal	Present	Present	Present
Interface	Up	Up	Up
MAC Addr	00:1F:7F:01:56:78	00:1F:7F:02:56:78	
IP Addressing Mode	Dynamic	Dynamic	
IP Addr	192.168.10.147 / 24	192.168.20.15 / 24	
Gateway	192.168.10.254	192.168.20.254	
DNS IP Addr	192.168.10.254	192.168.20.254	
Total Tx pkts	40164547451	40161328222	
Total Rx pkts	322592374382	11620037	
SFP E:			
SFP F:			

SFP A - Info		Temperature: 35.7 °C	Voltage: 3.22 V
		Rx Power: -4.18 dBm	Tx Power: -2.97 dBm
Status	Approved		
Vendor	Gigalight		
Part No	GGP-85192-SRC		
Vendor OUI	24-00-00		
Revision	1.0		
Serial No	M1901180211		
Identifier	SFP or SFP+		
Ext Identifier	GBIC/SFP function via two-wire only		
Connector Type	LC		
Encoding	64B/66B		

IP Receive - Flow Select		Multicast Requests: 1676 pairs sent				Analyzer: Interface: SFP A			
SFP	Set	Protocol	Type	Dst IP	Src IP	SSRC	Bandwidth	Packets	Seq errors
A	2110-30	96	239.168.20.120000	192.168.10.148.10000	0	1.666 Mbps	870155604	0	0
A	2110-30	97	239.168.10.120000	192.168.10.148.10000	0	21.888 Mbps	645007909	0	0
A	2110-30	97	239.168.10.320000	192.168.10.148.10000	0	2.738 Mbps	30825208	0	0
A	2110-30	97	239.168.10.320000	192.168.10.148.10000	0	21.888 Mbps	23972208	0	0
A	2110-40	100	239.168.40.120000	192.168.10.148.10000	0	43.271 Mbps	1972926	1	0
B	2110-20	96	239.168.20.220000	192.168.10.148.10000	0	1.666 Mbps	870155604	0	0
B	2110-30	97	239.168.10.220000	192.168.10.148.10000	0	21.888 Mbps	64497445	0	0
B	2110-30	97	239.168.10.220000	192.168.10.148.10000	0	21.888 Mbps	30825208	0	0
B	2110-30	97	239.168.20.220000	192.168.10.148.10000	0	21.888 Mbps	23972208	0	0
B	2110-40	100	239.168.40.220000	192.168.10.148.10000	0	43.271 Mbps	1972926	1	0
B	2110-40	100	239.168.40.120000	192.168.10.148.10000	0	43.271 Mbps	1972926	1	0

SFP IP Network

- Reporting of presence of SFPs, SFP MAC and IP addresses (flow source IP address), and interface status
- Tx and Rx packet counters for indication of traffic activity
- User configuration of SFP IP Addresses, Masks, Gateway and DNS addresses

SFP Information

- SFP status information for monitoring the physical network connection
- Indication of SFP vendor and laser characteristics
- RX and TX power for debug of fiber connectivity

IP Receive

- Reporting of the IP Flows available to the receiver and user selection of the required flows
- Indication of Qx locked status, Protocol, Src and Dst IP and Port Numbers, SSRC, Packet Counts, Sequence, payload and CRC errors
- Configuration of Multicast Destination IP addresses and subsequent Multicast Join requests

SMPTE 2110

SFP A - PTP Info		Standby System Reference	
GM Info	Qx Status	Messaging	
Communication Mode	Multicast (M/M)	Appl freq adjustmnt	
Delay Req Interval	Using GM value	Appl freq adj delta	
Announce Rec't Grace Period	3	Offset from Master	
Latency Offset	0 ns	Steps removed	
Local PTP State	Listening		

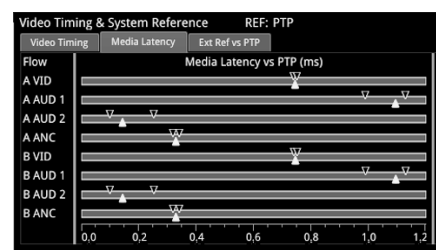

ST 2110 PTP Info - 2 port

- Control of PTP domain and communication mode (multicast, hybrid w/o negotiation)
- Indication of lock status
- Grandmaster information including leader ID and time source
- Indication of estimated frequency and phase lock offsets
- Indication of one step or two step traffic
- Two independent PTP followers

ST 2022-7 Status

- Indication of the health of ST 2022-7 seamless protection
- Warning of ST 2022-7 flow-pair mismatch
- Warnings of errors on flows and errors on reconstructed output and error rates per second
- Relative measure of Path Differential of flows on SFPB (Blue Network) relative to SFP A (Amber Network)
- Class A, B, C, D markers

IP Flow Latency

- Indication of media latency
- Indication of relative timing of audio and ANC flows wrt video
- Indication of relationship of underlying media to PTP
- External analog reference timing wrt PTP



Remote Access

Various methods are provided to enable you to establish a remote connection with your QxL or QxP system, depending on your requirements.



noVNC

- Browser remote access using noVNC technology to deliver 16 simultaneous scalable instruments over a remote network

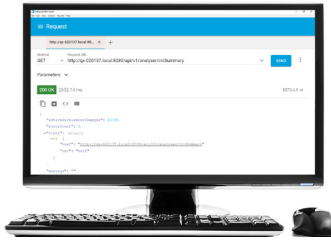

REST API

- QxL/QxP can be controlled remotely over a network via a REST API
- Integrated control, monitoring and automated manufacturer testing

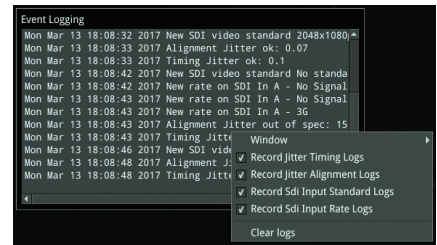

Event Logger

- SDI Input standard/status
- SDI physical layer timing and alignment jitter
- Rest API requests
- IP-Tx, IP-Rx, Flow and SFP records
- Reference Locking
- Audio input presence

LLDP Info		LLDP: Active	
	SFP A Neighbour	SFP B Neighbour	Mgmt Neighbour
Sys Name	switch-16628c	switch-16628c	phobos.phabrix.local
Sys Descr	MSN2010,Onyx,SW3...	MSN2010,Onyx,SW3...	Ubuntu 18.04.3 LTS Linux 4.15.0-88-generi...
Chassis ID	EC:0D:9A:FC:D0:00	EC:0D:9A:FC:D0:00	2C:4D:54:D4:07:A1
Port ID	Eth1/8	Eth1/11	00:1b:21:3a:45:d6
Port Descr			enp3s0
Mgmt IP	192.168.10.254	192.168.10.254	192.168.10.231
Primary VLAN	0	0	0

Qx Network & Automation	
Interface	Up
MAC Address	00:1F:7F:00:56:78
IP Addressing Mode	Dynamic
IP Address	192.168.0.104
Gateway	192.168.0.1
Default Gateway	192.168.0.1
DNS Server	192.168.0.10
mDNS Server	qx-022136.local
REST API	Listening on port 8080
VNC Server	No Connections

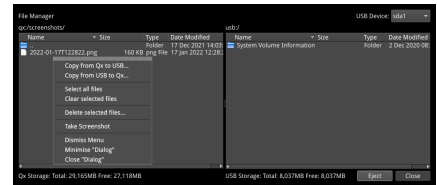

LLDP

- Identify port and device to which the QxL/QxP IP interfaces are connected
- Restrict information communicated over LLDP for IT security purposes
- Available in both ST 2110 and ST 2022-6 boot modes

Mgmt Interface Config

- Manual or Dynamic Addressing modes
- mDNS and DNS
- Select Default Gateway from Media or Management interfaces
- Control access to REST API and VNC

USB File Manager

- Copy presets, instrument logs, screenshots and user TIFF images to and from USB memory stick
- Delete selected files

Remote Connectivity

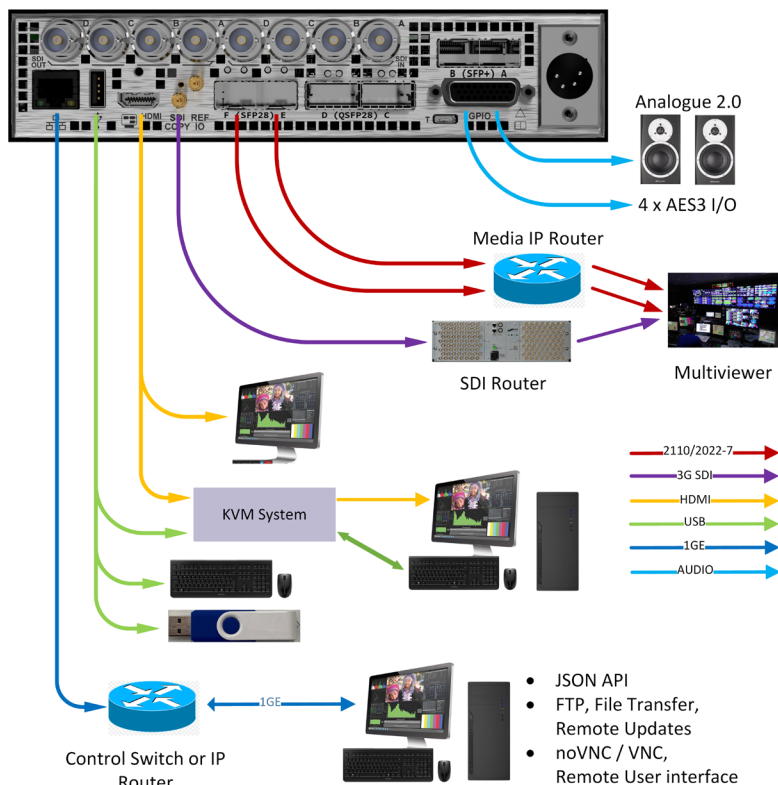

- File Transfer: FTP or Browser access to screenshots and PCAPs, User Test Patterns (TIFF), log files
- Remote Software Product Updates
- HDMI: UI video (1080p), UI audio (2-ch), local mouse
- SDI: UI video (1080p), UI audio (2-ch), local mouse
- noVNC: UI video (1080p low frame rate), remote mouse with screenshots
- KVM: HDMI or DVI (1080p compressed), remote mouse with screenshots
- ST 2110: UI (-20), Audio 2-ch (-30)
- UI audio available as analog on D26 (rear panel)
- Machine Control via JSON API
- Many KVM Options available - including Long Distance Connectivity, Cloud-based solutions, multiple access

- JSON API
- FTP, File Transfer, Remote Updates
- noVNC / VNC, Remote User interface

Optional Toolsets



Fast, automated 12G-SDI physical layer analysis [PHQXL01E-3G / PHQXP01E-3G]

The Physical Layer Toolset is a factory-fitted option for fast 12G/6G/3G/HD/SD*-SDI† physical layer commissioning, testing and development. Its RTE™ (Real-Time Eye) Technology instantly highlights any SMPTE compliance issues and its realtime SDI jitter window provides simultaneous monitoring across five specified frequency bands, jitter histogram and video trigger options. Built-in automation control allows testing to be performed faster, more reliably and at lower cost. Included in the option are a full range of SDI eye measurements including amplitude, DC offset, transition times, overshoot and health indication with both amplitude and time histograms, as well as choice of color, heat-map overlays and infinite persistence display.

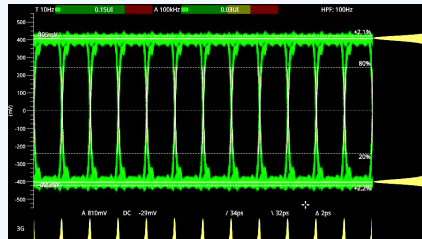
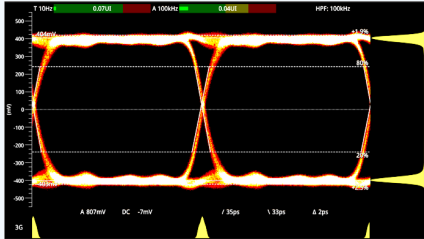

SDI EYE Analysis

- RTE™ (Real-Time Eye) for testing SMPTE compliance with indication of DC offset
- Automatic measurements of: DC level, amplitude, rise and fall time, rise/fall overshoot, visual rise time indication
- Amplitude and time histograms
- Single or multiple eyes with choice of color, heat-map overlay and infinite persistence
- Timing and Alignment jitter thermometers
- User-definable time measurement cursors

SDI Jitter Analysis

- Realtime SMPTE jitter measurements down to 10 Hz
- 10 Hz, 100 Hz, 1 kHz, 10 kHz, 100 kHz filters
- H, 2H, F, V Trigger
- Persistence control none to infinite
- +/- 0.25 to +/- 64 UI vertical scale adjustment
- Jitter amplitude histogram

Standard Eye Analysis

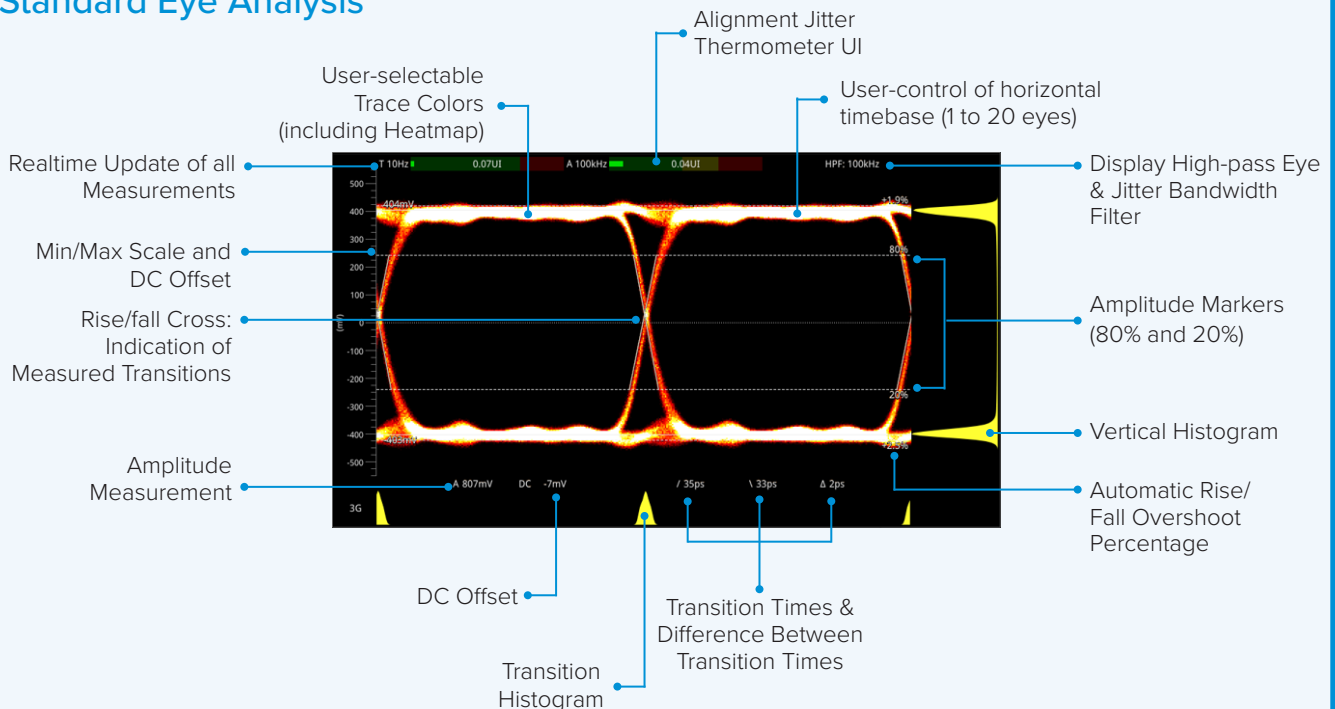

† Note: Optional UHD SDI formats require PHQXO-UHD

SDI-STRESS Testing

[PHQXLO-SDI-STRESS Requires PHQXLO1E-3G / PHQXPO-SDI-STRESS Requires PHQXP01E-3G]

The advanced SDI-STRESS option is available for stress testing and R&D evaluations of SDI interfaces up to 12G. A comprehensive API is included for rapid automation testing. The option includes the ability, under automation control, to insert SDI clock jitter from 10 Hz to 10 MHz (128 UI max) peak-to-peak, mute any of the SDI outputs, and control the SDI scrambler, sync-bit insertion, pre-emphasis, rise time and driver amplitude. The SDI-STRESS Eye amplitude measurement provides both Shorth Mean or Mode, with a histogram overlay and a user-defined window for the exploration of eye amplitude. Pseudo-Random Binary Sequence (PRBS) generation and analysis of PRBS-7, -9, -15, -23, -31 allows for deterministic measurement of link Bit Error Rates (BER).

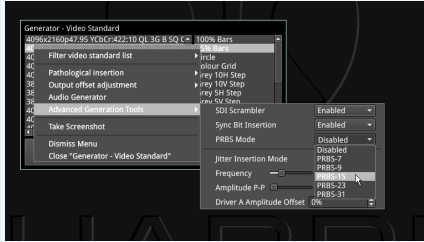

PRBS - Analysis

	Clock Rate	Total Rx (Gb)	Total Errors	BER
SDI A	385	3	3	1.9315e-10
SDI B	385	3	3	1.9315e-10
SDI C	385	3	3	1.9315e-10
SDI D	385	3	3	1.9315e-10

PRBS-31

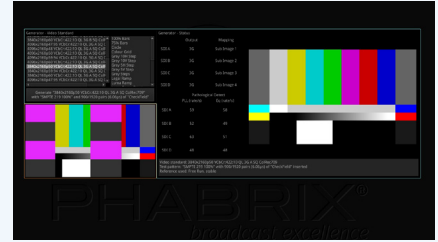

Adv. Generator Tools

- Control of jitter insertion frequency and amplitude
- SDI scrambler and sync bit Insertion on/off
- SDI Bit Error (BER) insertion tool
- Control of SDI driver amplitude +/- 15%
- Control of pre-emphasis, rise/fall time

PRBS Analyzer

- Indication of PRBS cumulative received data and PRBS type
- Generation of PRBS-7, -9, -15, -23, -31
- Reported cumulative errors
- Calculated Bit Error Rate (BER)

Pathological Detector

- Generator status indication of rate at which the video pattern generator is creating SDI pathological conditions
- Indication of PLL and EQ pathological rates per second
- Detection on each active SDI link
- Realtime GPI outputs of pathological detect for external equipment triggering

Advanced Eye Analysis

(Additional features with SDI-STRESS option)

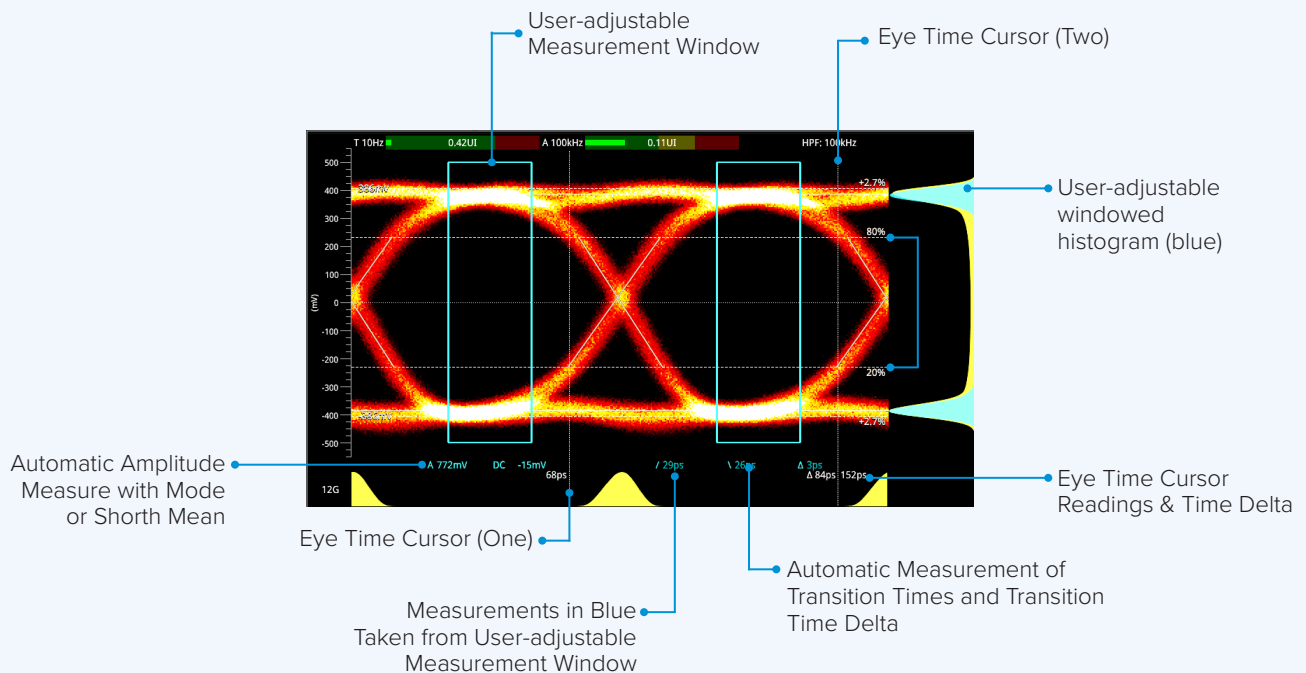

Optional Toolsets

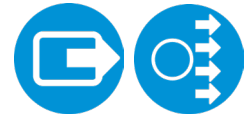

Audio and Video Generation

[Requires PHQXLO-GEN / PHQX0-GEN]

Simultaneously generate and analyze a comprehensive set of SDI and IP formats with the audio and video generation option. Moving test patterns with up to 32 channels of embedded audio per link or sub-field (up to 128 channels on 12G interfaces) is included. The Generator toolset option provides not only the core full screen SDI Pathological stress patterns (Eq, PLL, Clk, CheckField), but uniquely also allows the user to define a percentage combination of the SDI pathological and conventional generator patterns up to full frame. Importing TIFF files for checking of HDR/WCG graphics or display and evaluation with user-created test images is also included. The QxL and QxP offer a ST 2110-20 2K/HD, 4K/UHD video flow generator, 2110-30/-31 80 channel audio generator and 2110-40 ANC flow generator. Uniquely, the QxL and QxP can also generate both pattern and UI 2022-7 flow pairs. The GUI as a flow offers 1 x ST 2110-20 user interface video and 1 x 2110-30/-31 2.0 stereo monitoring bus audio with ST 2022-7. An IP Transmit configuration tool provides an at-a-glance view of transmitted flow status and selected formats.

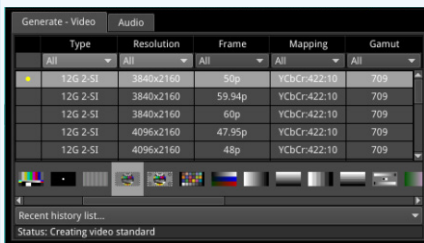

SDI⁺ Video Generation

- 12G/6G/3G/1.5G 4K/UHD and 2K/HD SDI signal generation
- Support for Single, Dual, Quad link SDI formats. Square division, 2SI, Level A & B
- 422, 444, 4224 and 4444, YCbCr and RGB formats, 10/12 bit
- Moving test patterns (bouncing box)
- Import/display TIFF images

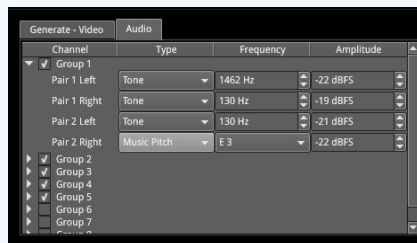

SDI⁺ Audio Generation

- Choice of fixed tones or chromatic scale – to assist channel identification
- Choice of fixed or ramp levels – to assist channel identification
- Custom config of number of active audio groups and channels
- Master gain control
- ST 2022-6: 32 channel audio generation can be replicated in all sub frames providing a total of up to 128 channels

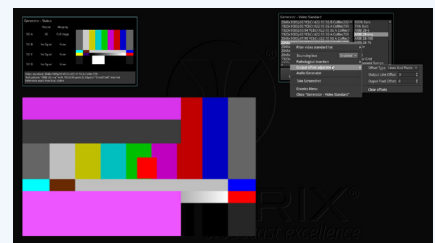

SDI⁺ Pathological Generation

- Conventional SDI pathological stress patterns, Eq, PLL and CheckField
- New proposed SMPTE combined pathological stress pattern: Eq + PLL + Color Bars + Clock
- Define a percentage combination of SMPTE or SDI pathological and conventional patterns up to full frame

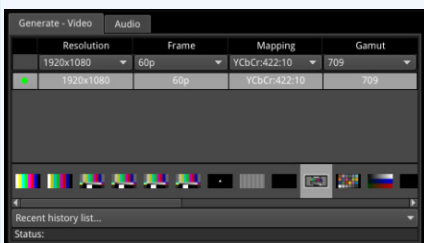

2110 Video/ANC Generation

- 2110: Generate ST 2110/2022-7 Test Signals as a flow
- 2110: Monitor (GUI) as a flow
- 2110-20: 2K/HD, 4K/UHD video flow generator (422/444, YCbCr/RGB, 10/12-bit)
- 2110-40: 1 x ANC flow generator
- Timecode Generator ATC_LTC, ATC_VITC, locked to PTP or Local Time with Jam Sync and Drop Frame, VITC1/2 Reverse and signaling of SDI Line number and H Offset
- Import of TIFF images
- Bouncing Box pattern movement
- ST 2110-20 EUHD 47.95-60p RGB YCbCr 444 formats [PHQXLO-EUHD / PHQXPO-EUHD]

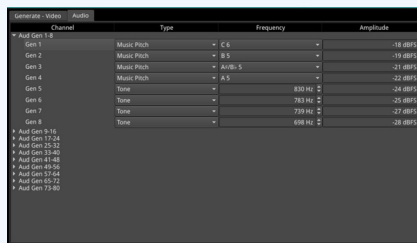

2110 Audio Generation

- 2110: Generate up to four ST 2110/2022-7 audio flows
- 2110-30/-31: Up to:
 - 80 audio channels 2110-30 at 125 µs
 - 60 audio channels 2110-31 at 125 µs
 - 10 audio channels 2110-30 at 1 ms
 - 7 audio channels 2110-31 at 1 ms

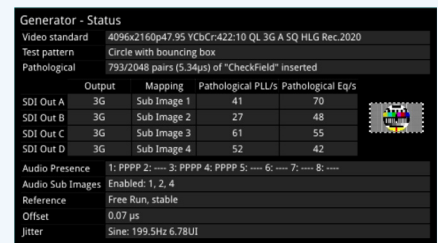

SDI⁺ Generator - Status

- Confirms generated Video Standard and Test Pattern details
- BNC output, SFP output and sub-image/full image mapping information
- Video Reference, output offset adjustment and Jitter insertion (with optional SDI-STRESS Toolkit) details
- Reporting of SDI-STRESS pathological insertion statistics

* Requires PHQXL01-3G / PHQXL01E-3G or PHQXP01-3G / PHQXP01E-3G

Optional Toolsets

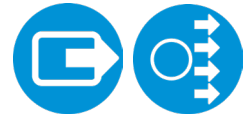

Audio and Video Generation [PHQXLO-GEN / PHQXPO-GEN]

IP Transmit - Tx Status

Current Total Bandwidth Used on SFP E Interface: 6.896 Gbps (27%)

Current Total Bandwidth Used on SFP F Interface: 6.896 Gbps (27%)

Active PTP Reference: PTP SFP E

Tx	VID	AUD1-2	AUD3-4	ANC	MON	Protocol	Type	Src IP	SSRC	Bandwidth	Packets
VID	E	2110-20	96	239.9.20.15178	01:00:5E:09:14:01	192.168.10.14	5178	123456	4.704 Gbps	425348909	
VID MON	E	2110-20	96	239.9.20.35178	01:00:5E:09:14:03	192.168.10.14	5178	123456	2.178 Gbps	1877543887	
AUD1	E	2110-30	97	239.9.30.15178	01:00:5E:09:1E:01	192.168.10.14	5178	123456	2.736 Mbps	510117915	
AUD2	E	2110-30	97	239.9.30.35178	01:00:5E:09:1E:03	192.168.10.14	5178	123456	2.736 Mbps	510117916	
AUD3	E	2110-30	97	239.9.30.55178	01:00:5E:09:1E:05	192.168.10.14	5178	123456	2.736 Mbps	510117909	
AUD4	E	2110-30	97	239.9.30.75178	01:00:5E:09:1E:07	192.168.10.14	5178	123456	2.736 Mbps	510117897	
AUD MON	E	2110-30	97	239.9.30.95178	01:00:5E:09:1E:09	192.168.10.14	5178	123456	2.736 Mbps	510117885	
ANC	E	2110-40	100	239.9.40.15178	01:00:5E:09:28:01	192.168.10.14	5178	123456	45.120 kbps	29657083	
VID	F	2110-20	96	239.9.20.25178	01:00:5E:09:14:02	192.168.20.17	5178	123456	4.704 Gbps	452328089	
VID MON	F	2110-20	96	239.9.20.45178	01:00:5E:09:14:04	192.168.20.17	5178	123456	2.178 Gbps	1877211826	
AUD1	F	2110-30	97	239.9.30.25178	01:00:5E:09:1E:02	192.168.20.17	5178	123456	2.736 Mbps	510116775	
AUD2	F	2110-30	97	239.9.30.45178	01:00:5E:09:1E:04	192.168.20.17	5178	123456	2.736 Mbps	510116778	
AUD3	F	2110-30	97	239.9.30.65178	01:00:5E:09:1E:06	192.168.20.17	5178	123456	2.736 Mbps	510116774	
AUD4	F	2110-30	97	239.9.30.85178	01:00:5E:09:1E:08	192.168.20.17	5178	123456	2.736 Mbps	510116765	
AUD MON	F	2110-30	97	239.9.30.105178	01:00:5E:09:1E:0A	192.168.20.17	5178	123456	2.736 Mbps	510116770	
ANC	F	2110-40	100	239.9.40.25178	01:00:5E:09:28:02	192.168.20.17	5178	123456	45.120 kbps	29667027	

- At-a-glance status overview of all flows being encapsulated and transmitted
- Simultaneously transmit two different types of flow from the unit: Generator Flows and Monitor (GUI) Flows
- Displays a summary of the current status of all selected generator / monitor video, audio and ancillary flows being transmitted
- Use this tab as an overview of all flows actively being transmitted from the unit, together with the active PTP reference and an indication of bandwidth used by each stream and the total bandwidth used on each interface
- Displays the current information about the test pattern VID, AUD, ANC and monitor VID and AUD flows

IP Transmit - VID, AUD1-2, AUD3-4, ANC, MON Status

IP Transmit SFP E: 4.809 Gbps (19%) SFP F: 4.809 Gbps (19%) Reference: PTP SFP E

Protocol: 2110-20 Enabled

Interface: Seamless E+F

Video Source: Generator - 1920x1080 p 60 YCbCr:422:10 BT709 SDR

Packet Read Schedule: Linear

Packing Mode: GPM Single Line

TR Offset: 0.000 μs

Displays the Active Settings for the Selected Flows

- The VID tab displays the active settings for the Video Generator: Protocol, Interface, Video Source, Packet Read Schedule, Packing Mode, TR Offset
- The AUD1-2, AUD3-4 tabs shows the active settings for the transmitted audio flows: Protocol, Packet Time, Channels, Audio Source
- The ANC tab displays the active settings for the Video Generator flows: Protocol, Interface, Packet Packing, Keep Alive, Timecode, TR Offset
- The MON tab displays the active settings for transmission of the Monitor flows: Protocol, Interface, Video Source, Packet Read Schedule, Audio Source, Packet Time, Channels,

Transmission Configuration

Configure Generator/Monitor Flows

Flow Enable/Disable

Configuration Options

Summary of Current Configuration

Generator	Monitor	Enabled
VID	Transmitter Interface Seamless E+F	Enabled
SFP Payload Type	96	Enabled
SFP Payload Type	97	Enabled
Source	Generator - 1280x720 p 50 YCbCr:422:10 BT709 SDR	Enabled
Packet Read Schedule	Gapped	Enabled
Packing Mode	GPM Single Line	Enabled
TR Offset	Custom 646.000 μs	Enabled
TR Offset ms	0	Enabled
TR Offset μs	646	Enabled
TR Offset ns	0	Enabled
AUD1	SFP E Dst: 239.9.30.15178 Src: 192.168.10.155178 123456 SFP F Dst: 239.9.30.25178 Src: 192.168.20.125178 123456 10 ch 2110-30	Enabled
AUD2	SFP E Dst: 239.9.30.35178 Src: 192.168.10.155178 123456 SFP F Dst: 239.9.30.45178 Src: 192.168.20.125178 123456 40 ch 125 μs 2110-31	Enabled
AUD3	SFP E Dst: 239.9.30.55178 Src: 192.168.10.155178 123456 SFP F Dst: 239.9.30.65178 Src: 192.168.20.125178 123456 2 ch 1 ms 2110-30	Enabled

- List of available flows in an expandable list
- Each minimized flow provides a single line summary of the current settings for information
- Configure the VID, AUD1, AUD2, AUD3, AUD4 Generator Flows
- Configure the VID MON, AUD MON Monitor flows
- 2110-20: Gapped/Linear Packet Read Schedule, BPM/GPM Packing Mode
- SDI/Egress Time Stamp, user control of TR Offset
- 2110-40 ANC, Keep Alive and ATC-LTC or ATC-VITC Timecode locked to PTP or Local Time

Optional Toolsets

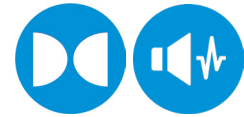

Dolby® E Decoder and Metadata Analyzer [PHQXLO-DOLBY / PHQXP0-DOLBY]

The Dolby E Decoder and Metadata Analyzer option provides a clear and accessible view of the Dolby E metadata present in a selected Dolby E or ED2 audio stream. It also enables you to check the correct timing of Dolby E packets in the audio signal in an SDI or ST 2022-6 broadcast chain. You can check whether the Dolby E is created correctly and transferred transparently by network equipment such as routers, switchers, satellite links, etc. You can also choose to monitor the Dolby® audio from any of the SDI/2022-6 embedded audio, 2110-30/-31 or AES inputs. The decoded output and downmix can be metered, monitored, Loudness measured, and routed to AES outputs.

Dolby Metadata Analyzer

Source Pair/Channel of the Dolby Bitstream

Dolby Begin/End Gain Values for Each Source Signal

Program-dependent Metadata for Dolby E Program 1

Program-dependent Metadata for Dolby E Program 2

Source	AUD2 Ch 3-4	Frame Rate	25	Original Rate	25	Bit Depth	20
Timecode	01:02:53:04	Contig	5.1+2	Programs	2	Errors	None
Begin Gain	0.00dB	0.00dB	0.00dB	0.00dB	0.00dB	0.00dB	0.00dB
End Gain	0.00dB	0.00dB	0.00dB	0.00dB	0.00dB	0.00dB	0.00dB

- Displays the Dolby E metadata present in the selected Dolby E or ED2 audio stream
- Enables you to check the correct timing of embedded Dolby E and ED2 in SDI and 2022-6 payloads
- Check that the Dolby E metadata has been created correctly for multiple programs using the easy to read metadata display
- You can choose to monitor the Dolby audio from any of the SDI, ST 2022-6 or 2110 input embedded audio pairs/channels or the AES input
- Dolby stream CRC error detection and display

Dolby Detection in Audio Metering

Group Pair Labels

Stereo Pair Selectors

Mono Channel Solo

Bus Selectors

Detect any Number of Dolby E, ED2, DD and DD+ Pairs

Numeric Values of Each Meter (dBFS)

Correlation Indicator for Each Audio Pair

Dolby Timing Line Number Absolute or Relative to Ideal

- Displays 16 audio meters together with peak level indicators and indication of audio pair correlation
- Dolby E, Dolby D and Dolby D+ streams are detected by the system with Dolby stream presence indicated in blue
- For an SDI or ST 2022-6 signal carrying embedded Dolby E audio, the Dolby E timing line number is also displayed below the detector, either as an absolute value or relative to the Ideal line number specified for that video standard

Dolby Decoder Metering and Status

8 Channels Automatically Identified from Dolby Program Metadata

2 Channels for 2.0 Stereo Downmix of Selected Dolby Program

8 Channel Audio Metering for Dolby E, and 2 Channels for Downmix

Dolby Decoder Panel and Status Information

Dolby Status
Dolby E 5.1+2

Source: S1 G2P2
Line: 50
Dialogue: -23 dB
Downmix: Program 1

- When the Dolby E decoder is selected as the metering source (ST 2110, SDI or 2022-6 mode), the view of the analyzer changes to display the 8 channels of decoded Dolby E audio as well as the stereo 2.0 downmix
- The meter channel identification is automatically configured from the Dolby program metadata
- Display of Dolby E source, line positioning (SDI, 2022-6), dialogue level and downmix program source

Optional Toolsets



10G/25G PCAP Tool [PHQXLO-IP-PCAP / PHQXPO-IP-PCAP]

This Packet Capture (PCAP) tool provides a flexible range of options for your capture of the live IP traffic on either a single or both Media interfaces while in ST 2110 Mode. The PCAP data is then saved to USB memory stick for offline analysis using third-party network analysis tools. The PCAP data on the USB stick can be accessed remotely via Web Browser.

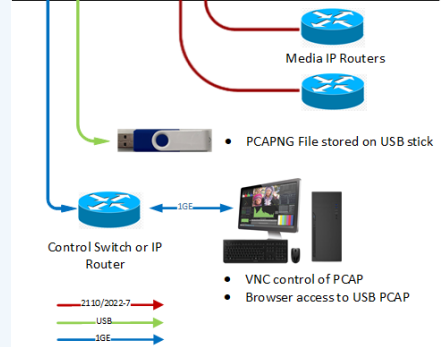
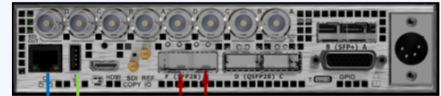
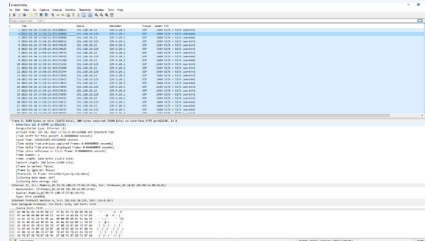
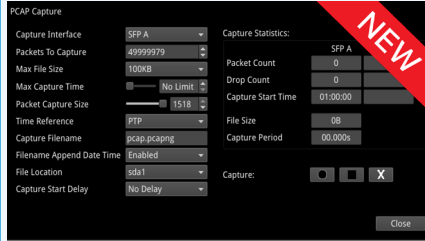

- Full line-rate capture at 25 Gbps on a single interface, back-to-back packets
- Capture data on one or both media interfaces simultaneously up to 50 Gbps
- User control of packet capture size - e.g. Full payload or headers only with user control of the Packet Capture size (12-1518 Octets)
- Manual Start-Stop, Auto Start-Stop at specified time, Capture Start Delay
- User controls for auto stop: No of Packets, File size, Duration
- Saves to USB stick with the option of Browser File transfer off the unit
- 4 GB PCAP max. file size

IP Network Traffic Measurement [PHQXLO-IP-MEAS / PHQXPO-IP-MEAS]

An advanced engineering suite of tools for ST 2110 analysis and debug offers the provision of up to four simultaneous dual Packet Interval Timing measurement windows per input for easy visualization of network congestion and sender packet distribution with max, mean and min inter-packet arrival times. Also included is detailed data reporting of flow packet, clock rates and PTP timing relationship, as well as the measurements of the ST 2110-21 Network Compatibility model (C_{INST}) and Virtual Receiver Buffer Model (VRX). Advanced measurement of IP flow latency and RTP clock timing relationships for debug of Audio, Video and ANC alignment, source PTP and encapsulation are featured.

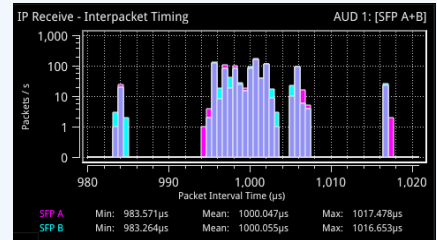

Inter-packet Timing

- Stream health reporting using histogram to show the distribution of inter-packet arrival times
- Simultaneous reporting of ST 2022-7 primary and secondary flow
- Packet counts (log or linear scales) mapped against arrival times (µs)
- Easy diagnosis of congestion with max, mean and min inter-packet arrival times

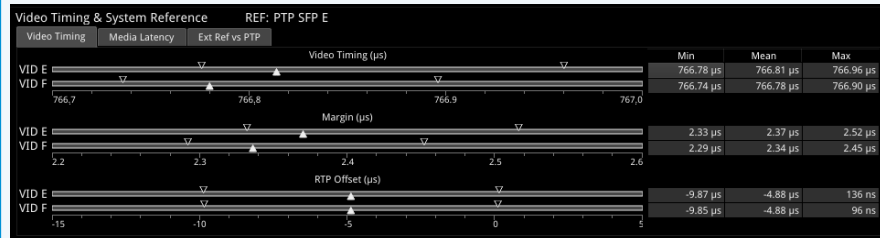

Advanced Media Timing - Video

- Time of First Received Packet of a Frame (video timing)
- Receiver Buffer Margin with respect to TR0default
- Sender RTP offset

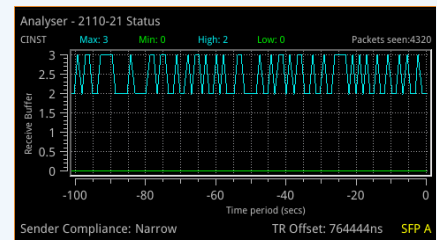

ST 2110-21

- ST 2110-21 measurement of Network Compatibility Model (C_{INST}) and Virtual Receiver Buffer Model (VRX)
- User control of VRX buffer read-schedule timing
- User control of C_{INST} buffer drain rate

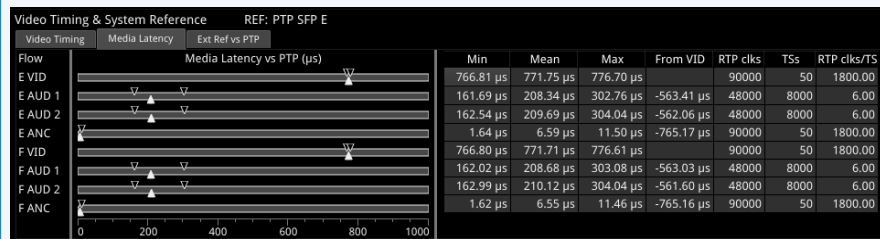

Advanced Media Timing - Media Latency

- Numerical display of Mean, Min and Max latency measurements
- Measured RTP clocks/s, Timestamps/s and RTP clocks/timestamp interval
- Numerical display of Video to Audio and ANC relative latency measurement

Packet Interval Profile Generator [PHQXLO-IP-NGT / PHQXPO-IP-NGT]

(Also Requires PHQXLO-GEN or PHQXPO-GEN)

A ST 2022-6 packet generation tool for evaluating the ability of a receiver to handle a ST 2022-6 flow with jitter. Simulate IP video network packet jitter under a variety of network conditions by adjusting the transmission distribution profile. View the interval timing distribution of generated packets, and the number of packets generated each second, against

the deviation of each packet interval from the expected interval time.

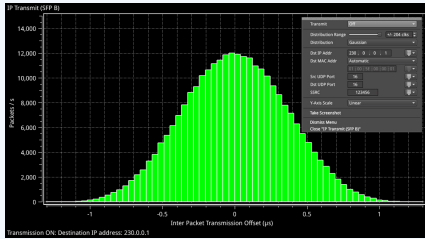

IP Transmit (ST 2022-6)

- Configuration of Transmission flow addresses, port numbers and SSRC
- Inter-packet jitter onto outgoing flow
- Gaussian or uniform distribution
- Flow control on/off

4K/UHD ST 2110 Extended UHD Format Support

[PHQXLO-EUHD / PHQXPO-EUHD]

(Also Requires PHQXLO-UHD or PHQXPO-UHD)

Out of the box the QxL and QxP support YCbCr 4:2:2 and YCbCr/RGB 444 formats in 2110-20 up to a max payload of approx 12 Gbps. If you are working with Extended Reality (xR), fixed installation LED walls and Graphics Card applications, then the PHQXLO-EUHD / PHQXPO-EUHD options provide

support for Analysis and Generation of UHD/4K YCbCr/RGB 444 formats in the range 47.95P – 60P.

Resolution	Frame	Mapping	Gamut
4096x2160	All	YCbCr422:10	HLG 2020
4096x2160	60p	YCbCr422:10	HLG 2020
4096x2160	59.94p	YCbCr422:12	HLG 2020
4096x2160	50p	YCbCr444:10	HLG 2020
4096x2160	48p	YCbCr444:12	HLG 2020
4096x2160	47.95p	RGB:10	HLG 2020
4096x2160	30p	YCbCr422:10	HLG 2020
4096x2160	29.97p	YCbCr422:10	HLG 2020
4096x2160	25p	YCbCr422:10	HLG 2020
4096x2160	24p	YCbCr422:10	HLG 2020
4096x2160	23.98p	YCbCr422:10	HLG 2020

EUHD Format Support

- Analysis of 2110-20 flows at UHD/4K 444 (RGB/YCbCr) 8/10/12 bit 47.95P-60P
- 4K60P RGB:12 Mean bandwidth approx. 20 Gbps (equivalent to a peak bandwidth of around 21 Gbps for a gapped flow)

High Dynamic Range (HDR) Visualization & Analysis Toolset [PHQXLO-HDR or PHQXPO-HDR]

The Qx Series' comprehensive HDR toolset includes a signal generator, CIE chart, Luma false color highlighting or *heat map*, waveform monitor and vectorscope. All the main live production SDR and HDR formats are supported: Standard Dynamic Range (SDR) BT.709, BT.2020 as well as HDR BT.2100 HLG, PQ and Sony S-Log3 and SR Live. The Waveform provides a Cd/m² (nits) graticule along with BT.2048 diffuse white markers. The flexible user controlled HDR heatmap offers 7 simultaneous programmable color overlay bands with presets for HDR and SDR ranges, plus a user custom preset. The CIE 1931 xy display provides overlays for BT.709, BT.2020 and ST.2086 gamut (P3) to enhance the visualization and analysis of your HDR / WCG content.

HDR Generator

An extensive set of test patterns include BT.2111 HDR color bars for HLG, PQ and SR Live as well as a full set of SDR 709 patterns mapped via *display light* to each of the four HDR formats for line checks, comparative monitor set-up and the evaluation of HDR to SDR converters.



False Color Highlighting

- Programmable *Heat Map* to highlight luminance zones providing quick identification of shadows, skin or mid-tones or specular highlights
- Seven simultaneous programmable color overlay bands
- Presets for HDR and SDR ranges plus user custom

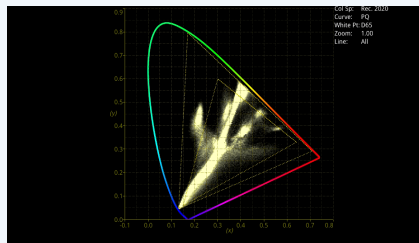

Analyzer - CIE Chart

- CIE 1931 xy display
- Single line mode linked to picture cursor
- Pan and zoom
- ITU-R BT. 709, BT. 2020 and ST 2086 gamut overlays
- Tooltip co-ordinate display
- Support for BT. 1886, BT. 2100 HLG and PQ, Sony S-Log3, SR Live

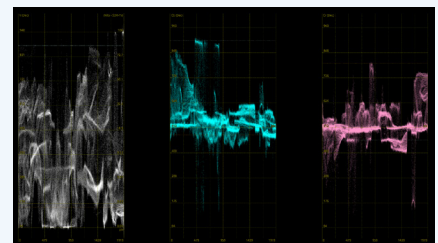

HDR Waveform

- Waveform HDR graticules with Nits (Cd/m²)
- BT. 2048 diffuse white markers
- Support for BT. 1886, BT. 2100 HLG and PQ, Sony S-Log3, SR Live

Specifications



Formats supported (Generation, Analysis & Monitoring)			
ST 2110-20/-30/-31/-40 / 2022-7 / 2022-6 Analysis over 10G Ethernet	○	●	●
ST 2110-20/-30/-31/-40 / 2022-7 / 2022-6 Analysis over 25G Ethernet	-	○	○
ST 2110-20/-30/-31/-40 / 2022-7 Generation	-	○	○
ST 2022-6 Generation	○	○	○
SDI IO	●	Factory Option	Factory Option
3G / 1.5G / 270M* SDI HD / SD* Analysis	●	Factory Option	Factory Option
3G / 1.5G / 270M* SDI HD Generation	○	○ [†]	○ [†]
12G / 6G / 3G / 1.5G SDI UHD Over SDI	○	○ [†]	○ [†]
25G IP Link Rates Over SFP28	-	○	○
Hardware and Software Options Supported			
Audio / Video Generator (SDI, ST 2022-6, ST 2110)	○ (SDI, 2022-6)	○ (SDI, 2022-6, 2110)	○ (SDI, 2022-6, 2110)
RTE** Real-Time Eye input (12G/6G/3G/HD/SD* SDI) x 1 (SDI input A) BNC	Factory Option	Factory Option	Factory Option
UHD / 4K Upgrade	○ (SDI)	○ (SDI, 2110)	○ (SDI, 2110)
SDI-STRESS Testing Toolset (Requires SDI Eye and Jitter Toolset)	○	○	○
Data View Analyzer, ANC Status and ANC Inspector	●	●	●
32 Channel Audio Metering and 5.1/2.0 Loudness Measurement	●	●	●
HDR/WCG Support	○	○	○
Dolby E Analysis	○	○	○
ST 2022-6, ST 2110/20/30/31/40 Decap with Class C Audio, ST 2022-7, Dual PTP	○	●	●
ST 2110 Network Traffic Measurement Toolset	○	○	○
ST 2022-6 Network Traffic Generator Toolset	○	○	○
ST 2110-20/30/31/40 Generator Toolset with Class C Audio, ST 2022-7	-	○	○
PCAP	○	○	○
EUHD Formats over 25G 2110-20	-	○	○
SDI inputs / outputs			
4 x SDI inputs, SD* / HD / 3G, 75 ohm terminated BNC	●	Factory Option	Factory Option
2 x SFP+ MSA / Non-MSA cages (12 Gbps copper or fiber SDI interfaces)	●	Factory Option	Factory Option
4 x SDI outputs, SD* / HD / 3G, 75 ohm BNC	●	Factory Option	Factory Option
Ethernet inputs / outputs (accepts generic SFPs)			
2 x SFP+ 10G Cages (shared with SDI SFP+ MSA/Non-MSA cages)	●	-	-
2 x SFP28 10 / 25G cages	-	●	●
2 x QSFP28 cages (Reserved)	-	○	○
Audio inputs / outputs			
4 x 75 ohm AES selectable I/O (26 pin high-density D-Type socket)	●	●	●
1 x Stereo analog audio output (26 pin high-density D-Type socket)	●	●	●
8 channel 48 kHz PCM audio on HDMI and SDI Instrument output	●	●	●
User interface			
Integrated 1920 x 1200 7 inch LCD multitouch touchscreen	-	-	●
HDMI instrument output, 1920 x 1080, 4:4:4 RGB, Type A	HDMI 1.4	HDMI 2.0a	HDMI 2.0a
SDI 3Gbit instrument out, 1920 x 1080, 4:2:2 YCbCr	BNC	Micro BNC	Micro BNC
ST 2110-20, ST 2110-30 instrument out, 1920 x 1080, 4:2:2 YCbCr	-	●	●
Remote Browser GUI access (noVNC)	●	●	●
Reference			
2 x 75 ohm BNC looping reference input, tri-level or B&B with cross lock	●	-	-
1 x 75 ohm Micro-BNC reference input, tri-level or B&B with cross lock	-	●	●
Networking & control			
10/100/1000 BASE-T	●	●	●
8 x bi-directional GPI (26 pin high-density D-Type socket)	●	●	●
Monitoring			
Integral Speaker / Headphone Socket (1/4")	-	-	●
Form factor			
Size (Width x Height x Depth - excluding projections)	211 x 44 x 253 mm	211 x 44 x 253 mm	215 x 132 x 330 mm
Weight	1.9 kg	1.9 kg	4.1 kg [‡]
Electrical			
4 pin XLR DC power connector	10-18V, 50W typical, 100W max	10-18V, 70W typical, 100W max	11-17V, 70W typical, 100W max
External power supply	90-264 VAC, 50 W typical, 120 W max	90-264 VAC, 70 W typical, 120 W max	-
Internal AC power supply with IEC connector	-	-	100-240 VAC, 77 typical, 110 W max
Choice of External Battery V-mount or Gold-mount	-	-	●
Warranty			
Warranty (1 year)	●	●	●
Extended Warranty Package (3 - 5 years)	○	○	○

Rear Panel - IO View

IP Only

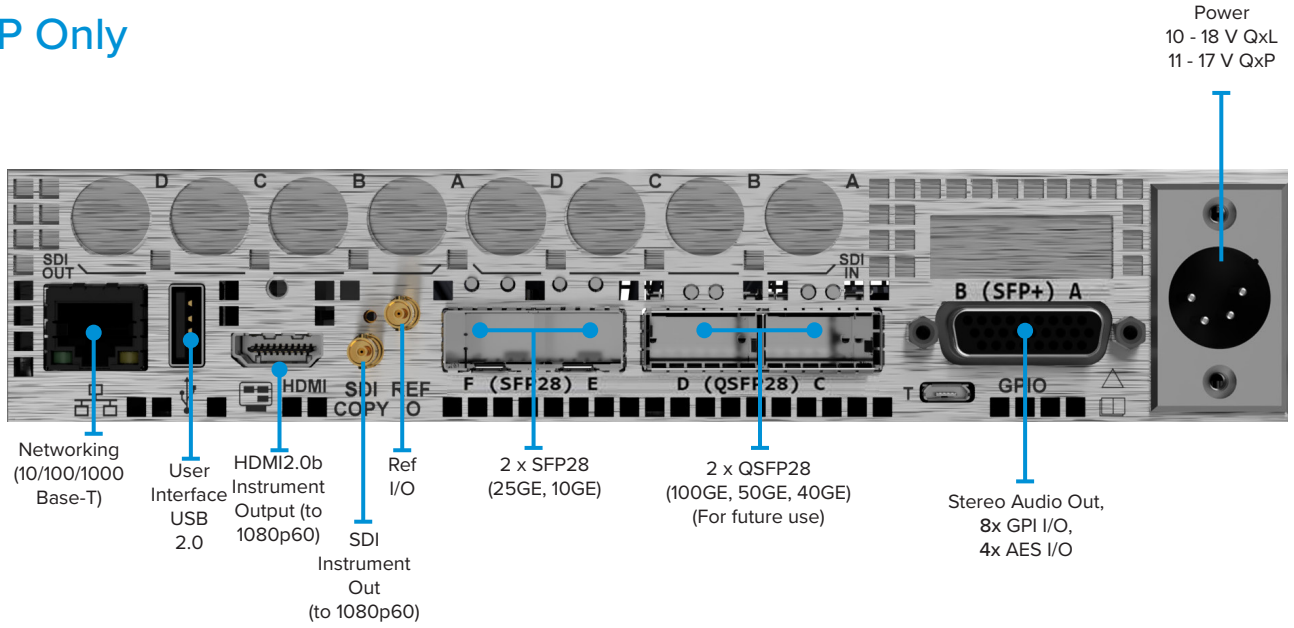

With Factory-fitted SDI Option

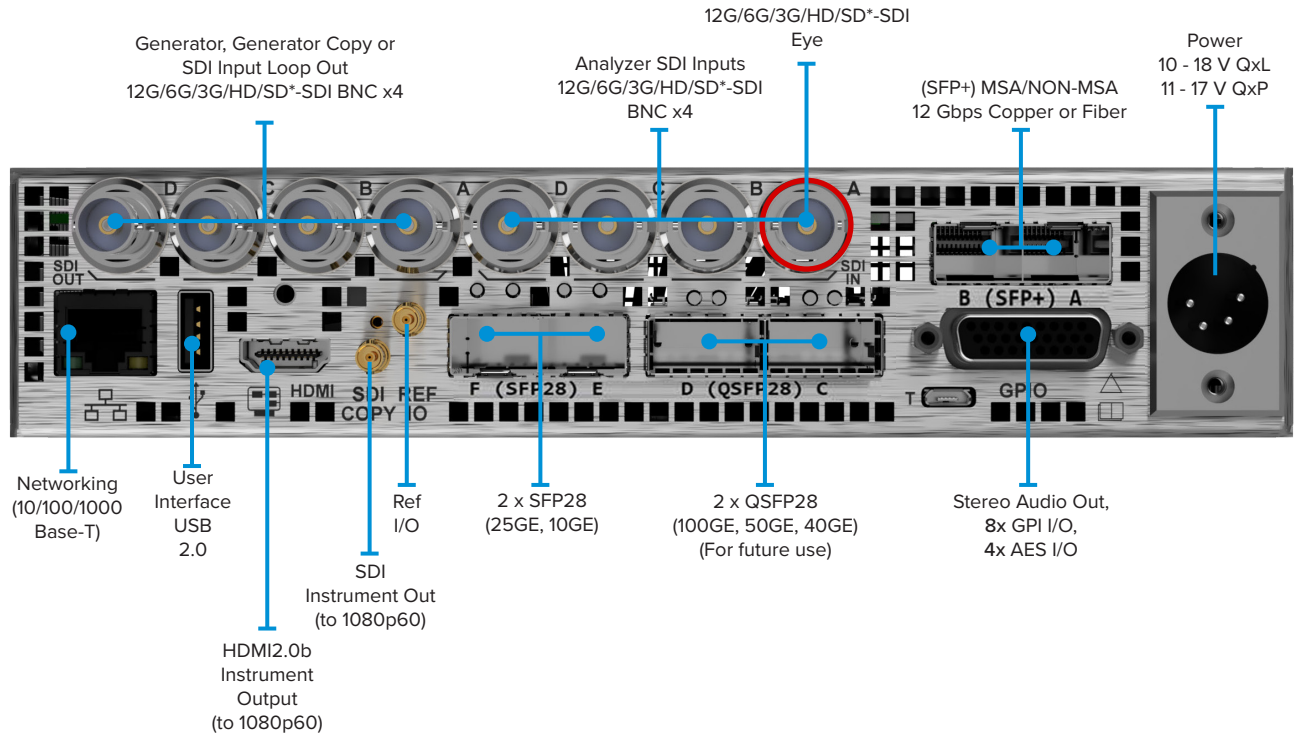

Ordering QxL

QxL Chassis Options

PHQXL	QxL 1U SD*/HD/2K 10GbE IP Rasterizer, Analyser only
PHQXL01-3G	QxL 1U SD*/HD/2K 10GbE IP/SDI Rasterizer, Analyser only
PHQXL01E-3G	QxL 1U SD*/HD/2K 10GbE IP/SDI Rasterizer, Eye/Jitter, Analyser only

QxL Chassis Upgrade Options

PHQXLM-01	QxL SDI I/O return to factory upgrade (requires PHQXL)
PHQXLM-01E	QxL SDI Eye/Jitter return to factory upgrade (requires PHQXL01-3G)

QxL IP Options

PHQXLO-IP-25G	25GbE media network (requires 2x PHSFP-25G-SR or PHSFP-25G-LR)
PHQXLO-EUHD	Adds RGB, 12b, 444, 48-60Hz formats to ST2110 (requires PHQXLO-UHD)
PHQXLO-IP-MEAS	IP Measurement 2110-21, PIT histograms, timing
PHQXLO-IP-PCAP	PCAP 2x25Gbps line rate capture tool, 4GB max.
PHQXLO-IP-NGT	2022-6 IP Network traffic Generator Tool (requires PHQXLO-GEN)
PHSFP-10GE-SR	SFP+ 10GBASE-SR Ethernet MM 850nm 300m
PHSFP-10GE-LR	SFP+ 10GBASE-LR Ethernet SM 1310nm 10km
PHSFP-25GE-SR	SFP28 25GBASE-SR Ethernet MM 850nm 100m
PHSFP-25GE-LR	SFP28 25GBASE-LR Ethernet SM 1310nm 10km

QxL SDI/IP Software Options

PHQXLO-DOLBY	Dolby E Decoder, Metadata Analyser, LTrt/LoRo downmix, metering
PHQXLO-GEN	SDI/IP AV Test Signal Generator (SDI requires PHQXL01-3G or PHQXL01E-3G)
PHQXLO-UHD	2K Extended + UHD/4K IP/SDI (ST 2110 requires PHQXLO-IP-25G) (SDI requires PHQXL01-3G or PHQXL01E-3G)
PHQXLO-HDR	HDR/WCG, CIE1931, HDR Heat map (PQ, HLG, S-Log3, SR Live)

QxL SDI Options

PHQXLO-SDI-STRESS	12G-SDI Stress Test Toolset (requires PHQXL01E-3G, PHQXLO-UHD, PHQXLO-GEN)
PHSFP-RT12-1310	SFP+ SM(10km) LC Non-MSA, Tx 1310nm, Rx 1260-1620nm 12G/6G/3G/HD/SD*-SDI

QxL Fitting Kits / Cables

PHQXC-1	12G-SDI Eye Measurement Test Cable 1m
PHQXK1	19 inch rackmount kit (1x Qx/QxL chassis)
PHQXK2	19 inch rackmount kit (2x Qx/QxL chassis)
PHQXK3	9.5 inch rackmount kit (1x Qx/QxL chassis)

QxL Extended Warranty

PHQXL-3YEAR	PHQXL Upgrade from 1 to 3 Year Warranty (excludes SFP)
PHQXL-5YEAR	PHQXL Upgrade from 1 to 5 Year Warranty (excludes SFP)
PHQXL01-3YEAR	PHQXL01 Upgrade from 1 to 3 Year Warranty (excludes SFP)
PHQXL01-5YEAR	PHQXL01 Upgrade from 1 to 5 Year Warranty (excludes SFP)
PHQXL01E-3YEAR	PHQXL01E Upgrade from 1 to 3 Year Warranty (excludes SFP)
PHQXL01E-5YEAR	PHQXL01E Upgrade from 1 to 5 Year Warranty (excludes SFP)

* Upcoming software release

Ordering QxP

QxP Chassis Options

PHQXP-V	QxP 3U SD*/HD/2K 10GbE IP Waveform Monitor/Analyser, V-mount
PHQXP-G	QxP 3U SD*/HD/2K 10GbE IP Waveform Monitor/Analyser, G-mount
PHQXP01-3G-V	QxP 3U SD*/HD/2K 10GbE IP/SDI Waveform Monitor/Analyser, V-mount
PHQXP01-3G-G	QxP 3U SD*/HD/2K 10GbE IP/SDI Waveform Monitor/Analyser, G-mount
PHQXP01E-3G-V	QxP 3U SD*/HD/2K 10GbE IP/SDI Waveform Monitor/Analyser, Eye/Jitter, V-mount
PHQXP01E-3G-G	QxP 3U SD*/HD/2K 10GbE IP/SDI Waveform Monitor/Analyser, Eye/Jitter, G-mount

QxP Chassis Upgrades (Return to Factory)

PHQXPM-01	QxP SDI I/O return to factory upgrade (requires PHQXP)
PHQXPM-01E	QxP SDI Eye/Jitter return to factory upgrade (requires PHQXP01-3G)

QxP IP Options

PHQXPO-IP-25G	25GbE media network (requires 2x PHSFP-25G-SR or PHSFP-25G-LR)
PHQXPO-EUHD	Add RGB, 12b, 444, 48-60Hz formats to ST2110 (requires PHQXPO-UHD)
PHQXPO-IP-MEAS	IP Measurement 2110-21, PIT histograms, timing
PHQXPO-IP-PCAP	PCAP 2x25Gbps line rate capture tool, 4GB max.
PHQXPO-IP-NGT	2022-6 IP Network traffic Generator Tool (requires PHQXPO-GEN)
PHSFP-10GE-SR	SFP+ 10GBASE-SR Ethernet MM 850nm 300m
PHSFP-10GE-LR	SFP+ 10GBASE-LR Ethernet SM 1310nm 10km
PHSFP-25GE-SR	SFP28 25GBASE-SR Ethernet MM 850nm 100m
PHSFP-25GE-LR	SFP28 25GBASE-LR Ethernet SM 1310nm 10km

QxP SDI/IP Software Options

PHQXPO-DOLBY	Dolby E Decoder, Metadata Analyser, LtRt/LoRo downmix, metering
PHQXPO-GEN	SDI/IP AV Test Signal Generator (SDI requires PHQXP01-3G or PHQXP01E-3G)
PHQXPO-UHD	2K Extended + UHD/4K IP/SDI (SDI requires PHQXP01-3G or PHQXP01E-3G)
PHQXPO-HDR	HDR/WCG, CIE1931, HDR Heat map (PQ, HLG, S-Log3, SR Live)

QxP SDI Options

PHQXPO-SDI-STRESS	12G-SDI Stress Test Toolset (requires PHQXP01E-3G, PHQXPO-UHD, PHQXPO-GEN)
PHSFP-RT12-1310	SFP+ SM(10km) LC Non-MSA, Tx 1310nm, Rx 1260-1620nm SD*/HD/3G/6G/12G-SDI

QxP Fitting Kits

PHQXC-1	12G-SDI Eye Measurement Test Cable 1m
PHQXK7	3U 19 inch rackmount kit (1x QxP Chassis)
PHQXK8	3U 19inch rackmount kit (2x QxP Chassis)
PHQXK9	QxP desktop kit (adjustable feet plus handle)

QxP Extended Warranty

PHQXP-3YEAR	PHQXP Upgrade from 1 to 3 Year Warranty (excludes SFP)
PHQXP-5YEAR	PHQXP Upgrade from 1 to 5 Year Warranty (excludes SFP)
PHQXP01-3YEAR	PHQXP01 Upgrade from 1 to 3 Year Warranty (excludes SFP)
PHQXP01-5YEAR	PHQXP01 Upgrade from 1 to 5 Year Warranty (excludes SFP)
PHQXP01E-3YEAR	PHQXP01E Upgrade from 1 to 3 Year Warranty (excludes SFP)
PHQXP01E-5YEAR	PHQXP01E Upgrade from 1 to 5 Year Warranty (excludes SFP)

* Upcoming software release

SDI SFP Interfaces

[Requires PHQXL01-3G / PHQXP01-3G or PHQXL01E-3G / PHQXP01E-3G]

SDI SFP Interface	Link Type	SFP+B Link Rates		SFP+A Link Rates	
SDI Transceivers Only					
One SDI Transceiver in Cage A	SFP Interface	N/A	N/A	Rx Ch1	Tx Ch1
	Single Link: Rx/Tx	N/A	N/A	BNC A Rx 0.27*/1.5/3/6/12	BNC A Tx 0.27*/1.5/3/6/12
	Dual Link: N/A	N/A	N/A	N/A	N/A
	Quad Link: N/A	N/A	N/A	N/A	N/A
Two SDI Transceivers in Cages A & B	SFP Interface	Rx Ch1	Tx Ch1	Rx Ch1	Tx Ch1
	Single Link: Rx/Tx	N/A	BNC C Tx (Tx Copy) 0.27*/1.5/3/6/12	BNC A Rx 0.27*/1.5/3/6/12	BNC A Tx 0.27*/1.5/3/6/12
	Dual Link: Rx/Tx	BNC C Rx 0.27*/1.5/3/6	BNC C Tx 0.27*/1.5/3/6	BNC A Rx 0.27*/1.5/3/6	BNC A Tx 0.27*/1.5/3/6
	Quad Link: N/A	N/A	N/A	N/A	N/A
SDI Dual Receivers Only					
One SDI Dual Receiver in Cage A	SFP Interface	N/A	N/A	Rx Ch1	Rx Ch2
	Single Link: Rx	N/A	N/A	BNC A Rx 0.27*/1.5/3/6/12	N/A
	Dual Link: Rx	N/A	N/A	BNC A Rx 0.27*/1.5/3/6	BNC B Rx 0.27*/1.5/3/6
	Quad Link: N/A	N/A	N/A	N/A	N/A
Two SDI Dual Receivers in Cages A & B	SFP Interface	Rx Ch1	Rx Ch2	Rx Ch1	Rx Ch2
	Single Link: Rx	N/A	N/A	BNC A Rx 0.27*/1.5/3/6/12	N/A
	Dual Link: Rx	N/A	N/A	BNC A Rx 0.27*/1.5/3/6	BNC B Rx 0.27*/1.5/3/6
	Quad Link: Rx ^{1 2}	BNC C Rx 0.27*/1.5/3	BNC D Rx 0.27*/1.5/3	BNC A Rx 0.27*/1.5/3	BNC B Rx 0.27*/1.5/3
SDI Dual Transmitters Only					
One SDI Dual Transmitter in Cage A	SFP Interface	N/A	N/A	Tx Ch2	Tx Ch1
	Single Link: Tx	N/A	N/A	BNC B Tx (Tx Copy) 0.27*/1.5/3/6	BNC A Tx 0.27*/1.5/3/6/12
	Dual Link: Tx	N/A	N/A	BNC B Tx 0.27*/1.5/3/6	BNC A Tx 0.27*/1.5/3/6
	Quad Link: N/A	N/A	N/A	N/A	N/A
Two SDI Dual Transmitters in Cages A & B	SFP Interface	Tx Ch2	Tx Ch1	Tx Ch2	Tx Ch1
	Single Link: Tx	BNC D Tx (Tx Copy) 0.27*/1.5/3/6	BNC C Tx (Tx Copy) 0.27*/1.5/3/6/12	BNC B Tx (Tx Copy) 0.27*/1.5/3/6	BNC A Tx 0.27*/1.5/3/6/12
	Dual Link: Tx	BNC D Tx (Tx Copy) 0.27*/1.5/3/6	BNC C Tx (Tx Copy) 0.27*/1.5/3/6	BNC B Tx 0.27*/1.5/3/6	BNC A Tx 0.27*/1.5/3/6
	Quad Link: Tx ^{2 3}	BNC D Tx 0.27*/1.5/3	BNC C Tx 0.27*/1.5/3	BNC B Tx 0.27*/1.5/3	BNC A Tx 0.27*/1.5/3
SDI Dual Transmitter plus SDI Dual Receiver					
One SDI Dual Transmitter (Cage A) and One Dual SDI Receiver (Cage B)	SFP Interface	Rx Ch1	Rx Ch2	Tx Ch2	Tx Ch1
	Single Link: Rx/Tx	BNC C Rx 0.27*/1.5/3/6/12	N/A	BNC B Tx (Tx Copy) 0.27*/1.5/3/6	BNC A Tx 0.27*/1.5/3/6/12
	Dual Link: Rx/Tx	BNC C Rx 0.27*/1.5/3/6	BNC D Rx 0.27*/1.5/3/6	BNC B Tx 0.27*/1.5/3/6	BNC A Tx 0.27*/1.5/3/6
	Quad Link: N/A	N/A	N/A	N/A	N/A

¹ In quad link 2SI the Receivers will auto adapt to any order of sub-image to BNC mapping.

² In quad link square division the sub image order is: BNC A:TL, BNC B:TR, BNC C:BL, BNC D:BR.

³ In quad link 2SI the sub image order is: BNC A:Sub 1, BNC B:Sub 2, BNC C:Sub 3, BNC D:Sub 4.

Supported 2K/HD/SD* SDI Formats

The following SDI formats are available on QxL and QxP.

SMPTE Stnds. Link (Content)	Interface	Resolution	Sampling Structure	Pixel Depth	Frame/Field Rate	HDR [†]	SDI [‡]	2022-6
ST 259 (ST 125)	SD (625i) *	720 x 576	4:2:2 (YCbCr)	10	50i	-	OA	A
ST 259 (ST 125)	SD (525i) *	720 x 485	4:2:2 (YCbCr)	10	59.94i	-	OA	A
ST 292 (ST 296)	HD	1280 x 720	4:2:2 (YCbCr)	10	60p, 59.94p, 50p, 30p, 29.97p, 25p,	○●	○●	●
ST 292 (ST 274)	HD	1920 x 1080	4:2:2 (YCbCr)	10	60i, 59.94i, 50i 30p, 29.97p, 25p, 24p, 23.98p	○●	○●	●
ST 292 (RP 211)	HD	1920 x 1080	4:2:2 (YCbCr)	10	30psF, 29.97PsF, 25psF, 24PsF, 23.98PsF	○●	○●	●
ST 292 (ST 2048-2)	HD	2048 x 1080	4:2:2 (YCbCr)	10	30p, 29.97p, 25p, 24p, 23.98p, 30PsF, 29.97PsF, 25PsF, 24PsF, 23.98PsF	○●	○●	●
ST 372 (ST 274)	Dual Link HD	1920 x 1080	4:2:2 (YCbCr)	10	60p, 59.94p, 50p	○●	○●	-
ST 372 (ST 274)	Dual Link HD	1920 x 1080	4:4:4 (YCbCr/RGB) 4:4:4:4 (YCbCrA/RGBA)	10	60i, 59.94i, 50i, 30PsF, 29.97PsF, 25PsF, 24PsF, 23.98PsF 30p, 29.97p, 25p, 24p, 23.98p	○●	○●	-
ST 372 (ST 274)	Dual Link HD	1920 x 1080	4:4:4 (YCbCr/RGB)	12	60i, 59.94i, 50i 30p, 29.97p, 25p, 24p, 23.98p	○●	○●	-
ST 372 (ST 274)	Dual Link HD	1920 x 1080	4:2:2 (YCbCr)	12	60i, 59.94i, 50i, 30PsF, 29.97PsF, 25PsF, 24PsF, 23.98PsF 30p, 29.97p, 25p, 24p, 23.98p	○●	○●	-
ST 372 (ST 2048-2)	Dual Link HD	2048 x 1080	4:2:2 (YCbCr)	10	60p, 59.94p, 50p, 48p, 47.95p	○●	○●	-
ST 372 (ST 2048-2)	Dual Link HD	2048 x 1080	4:4:4 (YCbCr/RGB) 4:4:4:4 (YCbCrA/RGBA)	10	30PsF, 29.97PsF, 25PsF, 24PsF, 23.98PsF 30p, 29.97p, 25p, 24p, 23.98p	○●	○●	-
ST 372 (ST 2048-2)	Dual Link HD	2048 x 1080	4:4:4 (YCbCr/RGB)	12	30PsF, 29.97PsF, 25PsF, 24PsF, 23.98PsF 30p, 29.97p, 25p, 24p, 23.98p	○●	○●	-
ST 372 (ST 2048-2)	Dual Link HD	2048 x 1080	4:2:2 (YCbCr) 4:2:2:4 (YCbCrA)	12	30PsF, 29.97PsF, 25PsF, 24PsF, 23.98PsF 30p, 29.97p, 25p, 24p, 23.98p	○●	○●	-
ST 425-1 (ST 274)	3G Level A (I)	1920 x 1080	4:2:2 (YCbCr)	10	60p, 59.94p, 50p	○●	○●	●
ST 425-1 (ST 2048-2)	3G Level A (I)	2048 x 1080	4:2:2 (YCbCr)	10	60p, 59.94p, 50p, 48p, 47.95p	○●	○●	●
ST 425-1 (ST 296)	3G Level A (2)	1280 x 720	4:4:4 (YCbCr/RGB) 4:4:4:4 (YCbCrA/RGBA)	10	60p, 59.94p, 50p, 30p, 29.97p	○●	○●	●
ST 425-1 (ST 274)	3G Level A (2)	1920 x 1080	4:4:4 (YCbCr/RGB) 4:4:4:4 (YCbCrA/RGBA)	10	60i, 59.94i, 50i, 30PsF, 29.97PsF, 25PsF, 24PsF, 23.98PsF 30p, 29.97p, 25p, 24p, 23.98p	○●	○●	●
ST 425-1 (ST 2048-2)	3G Level A (2)	2048 x 1080	4:4:4 (YCbCr/RGB) 4:4:4:4 (YCbCrA/RGBA)	10	30PsF, 29.97PsF, 25PsF, 24PsF, 23.98PsF 30p, 29.97p, 25p, 24p, 23.98p	○●	○●	●
ST 425-1 (ST 274)	3G Level A (3)	1920 x 1080	4:4:4 (YCbCr/RGB)	12	60i, 59.94i, 50i, 30p, 29.97p, 25p, 24p, 23.98p	○●	○●	●
ST 425-1 (ST 2048-2)	3G Level A (3)	2048 x 1080	4:4:4 (YCbCr/RGB)	12	30PsF, 29.97PsF, 25PsF, 24PsF, 23.98PsF 30p, 29.97p, 25p, 24p, 23.98p	○●	○●	●
ST 425-1 (ST 274)	3G Level A (4)	1920 x 1080	4:2:2 (YCbCr)	12	60i, 59.94i, 50i, 30PsF, 29.97PsF, 25PsF, 24PsF, 23.98PsF 30p, 29.97p, 25p, 24p, 23.98p	○●	○●	●
ST 425-1 (ST 2048-2)	3G Level A (4)	2048 x 1080	4:2:2 (YCbCr) 4:2:2:4 (YCbCrA)	12	30PsF, 29.97PsF, 25PsF, 24PsF, 23.98PsF 30p, 29.97p, 25p, 24p, 23.98p	○●	○●	●
ST 425-1 (ST 274)	3G Level B-DL (I)	1920 x 1080	4:2:2 (YCbCr)	10	60p, 59.94p, 50p	○●	○●	●
ST 425-1 (ST 2048-2)	3G Level B-DL (I)	2048 x 1080	4:2:2 (YCbCr)	10	60p, 59.94p, 50p, 48p, 47.95p	○●	○●	●
ST 425-1 (ST 274)	3G Level B-DL (II)	1920 x 1080	4:4:4 (YCbCr/RGB) 4:4:4:4 (YCbCrA/RGBA)	10	60i, 59.94i, 50i, 30PsF, 29.97PsF, 25PsF, 24PsF, 23.98PsF 30p, 29.97p, 25p, 24p, 23.98p	○●	○●	●
ST 425-1 (ST 2048-2)	3G Level B-DL (II)	2048 x 1080	4:4:4 (YCbCr/RGB) 4:4:4:4 (YCbCrA/RGBA)	10	30PsF, 29.97PsF, 25PsF, 24PsF, 23.98PsF 30p, 29.97p, 25p, 24p, 23.98p	○●	○●	●
ST 425-1 (ST 274)	3G Level B-DL (III)	1920 x 1080	4:4:4 (YCbCr/RBG)	12	60i, 59.94i, 50i, 30p, 29.97p, 25p, 24p, 23.98p	○●	○●	●
ST 425-1 (ST 2048-2)	3G Level B-DL (III)	2048 x 1080	4:4:4 (YCbCr/RBG)	12	30PsF, 29.97PsF, 25PsF, 24PsF, 23.98PsF 30p, 29.97p, 25p, 24p, 23.98p	○●	○●	●
ST 425-1 (ST 274)	3G Level B-DL (IV)	1920 x 1080	4:2:2 (YCbCr)	12	60i, 59.94i, 50i, 30PsF, 29.97PsF, 25PsF, 24PsF, 23.98PsF 30p, 29.97p, 25p, 24p, 23.98p	○●	○●	●
ST 425-1 (ST 2048-2)	3G Level B-DL (IV)	2048 x 1080	4:2:2 (YCbCr) 4:2:2:4 (YCbCrA)	12	30PsF, 29.97PsF, 25PsF, 24PsF, 23.98PsF 30p, 29.97p, 25p, 24p, 23.98p	○●	○●	●

KEY

- - Generator with PHQXLO-GEN / PHQXPO-GEN option and Analyzer
- - Optional
- - Optional Generator with PHQXLO-GEN / PHQXPO-GEN option and Analyzer
- A - Analyzer Only
- '-' - Not Available

[†] **Note:** Optional HDR formats require PHQXLO-HDR or PHQXPO-HDR

[‡] **Note:** SDI formats require PHQXL01-3G / PHQXP01-3G or PHQXL01E-3G / PHQXP01E-3G

* Upcoming Software Release

Supported 2K/HD/SD* IP Formats

The following 2K/HD/SD* ST 2110-20 formats are provided as standard.

Resolution	Sampling Structure	Pixel Depth	Frame/Field Rate	2110 HDR*	2110 SDR
720 x 576*	4:2:2 (YCbCr)	10	50i	-	A
720 x 485*	4:2:2 (YCbCr)	10	59.94i	-	A
1280 x 720	4:2:2 (YCbCr)	8	60p, 59.94p, 50p, 48p, 47.97p, 30p, 29.97p, 25p, 24p, 23.98p	OA	A
1280 x 720	4:2:2 (YCbCr)	10	60p, 59.94p, 50p, 48p, 47.97p, 30p, 29.97p, 25p, 24p, 23.98p	O●	●
1280 x 720	4:4:4(YCbCr/RGB)	8	60p, 59.94p, 50p, 48p, 47.97p, 30p, 29.97p, 25p, 24p, 23.98p	OA	A
1280 x 720	4:4:4(YCbCr/RGB)	10	60p, 59.94p, 50p, 48p, 47.97p, 30p, 29.97p, 25p, 24p, 23.98p	O●	●
1920 x 1080	4:2:2(YCbCr)	8	60i, 59.94i, 50i	OA	A
1920 x 1080	4:2:2 (YCbCr)	10	60i, 59.94i, 50i	O●	●
1920 x 1080	4:2:2(YCbCr)	12	60i, 59.94i, 50i	O●	●
1920 x 1080	4:4:4(YCbCr/RGB)	8	60i, 59.94i, 50i	OA	A
1920 x 1080	4:4:4(YCbCr/RGB)	10	60i, 59.94i, 50i	O●	●
1920 x 1080	4:4:4(YCbCr/RGB)	12	60i, 59.94i, 50i	O●	●
1920 x 1080	4:2:2 (YCbCr)	8	60p, 59.94p, 50p, 48p, 47.97p, 30p, 29.97p, 25p, 24p, 23.98p	OA	A
1920 x 1080	4:2:2 (YCbCr)	10	60p, 59.94p, 50p, 48p, 47.97p, 30p, 29.97p, 25p, 24p, 23.98p	O●	●
1920 x 1080	4:2:2 (YCbCr)	12	60p, 59.94p, 50p, 48p, 47.97p, 30p, 29.97p, 25p, 24p, 23.98p	O●	●
1920 x 1080	4:4:4(YCbCr/RGB)	8	60p, 59.94p, 50p, 48p, 47.97p, 30p, 29.97p, 25p, 24p, 23.98p	OA	A
1920 x 1080	4:4:4(YCbCr/RGB)	10	60p, 59.94p, 50p, 48p, 47.97p, 30p, 29.97p, 25p, 24p, 23.98p	O●	●
1920 x 1080	4:4:4(YCbCr/RGB)	12	60p, 59.94p, 50p, 48p, 47.97p, 30p, 29.97p, 25p, 24p, 23.98p	O●	●
1920 x 1080	4:2:2 (YCbCr)	8	30PsF, 29.97PsF, 25PsF, 24PsF, 23.97PsF	OA	A
1920 x 1080	4:2:2 (YCbCr)	10	30PsF, 29.97PsF, 25PsF, 24PsF, 23.98PsF	O●	●
1920 x 1080	4:2:2 (YCbCr)	12	30PsF, 29.97PsF, 25PsF, 24PsF, 23.97PsF	O●	●
1920 x 1080	4:4:4(YCbCr/RGB)	8	30PsF, 29.97PsF, 25PsF, 24psF, 23.97PsF	OA	A
1920 x 1080	4:4:4(YCbCr/RGB)	10	30psF, 29.97psF, 25psF, 24PsF, 23.97PsF	O●	●
1920 x 1080	4:4:4(YCbCr/RGB)	12	30PsF, 29.97PsF, 25PsF, 24PsF, 23.97PsF	O●	●
2048 x 1080	4:2:2 (YCbCr)	8	60p, 59.94p, 50p, 48p, 47.97p, 30p, 29.97p, 25p, 24p, 23.98p	OA	A
2048 x 1080	4:2:2 (YCbCr)	10	60p, 59.94p, 50p, 48p, 47.97p, 30p, 29.97p, 25p, 24p, 23.98p	O●	●
2048 x 1080	4:2:2 (YCbCr)	12	60p, 59.94p, 50p, 48p, 47.97p, 30p, 29.97p, 25p, 24p, 23.98p	O●	●
2048 x 1080	4:4:4(YCbCr/RGB)	8	60p, 59.94p, 50p, 48p, 47.97p, 30p, 29.97p, 25p, 24p, 23.98p	OA	A
2048 x 1080	4:4:4(YCbCr/RGB)	10	60p, 59.94p, 50p, 48p, 47.97p, 30p, 29.97p, 25p, 24p, 23.98p	O●	●
2048 x 1080	4:4:4(YCbCr/RGB)	12	60p, 59.94p, 50p, 48p, 47.97p, 30p, 29.97p, 25p, 24p, 23.98p	O●	●
2048 x 1080	4:2:2(YCbCr)	8	30PsF, 29.97PsF, 25PsF, 24PsF, 23.97PsF	OA	A
2048 x 1080	4:2:2(YCbCr)	10	30PsF, 29.97PsF, 25PsF, 24PsF, 23.97PsF	O●	●
2048 x 1080	4:2:2(YCbCr)	12	30PsF, 29.97PsF, 25PsF, 24PsF, 23.97PsF	O●	●
2048 x 1080	4:4:4(YCbCr/RGB)	8	30PsF, 29.97PsF, 25PsF, 24PsF, 23.97PsF	OA	A
2048 x 1080	4:4:4(YCbCr/RGB)	10	30PsF, 29.97PsF, 25PsF, 24PsF, 23.97PsF	O●	●
2048 x 1080	4:4:4(YCbCr/RGB)	12	30PsF, 29.97PsF, 25PsF, 24PsF, 23.97PsF	O●	●

KEY

- - Generator with PHQXLO-GEN / PHQXPO-GEN option and Analyzer
- O - Optional
- O● - Optional Generator with PHQXLO-GEN / PHQXPO-GEN option and Analyzer
- A - Analyzer Only
- '-' - Not Available

* **Note:** Optional HDR formats require PHQXLO-HDR or PHQXPO-HDR

* Upcoming Software Release

Supported 4K/UHD Formats

The following SDI formats are optional on QxL/QxP

[PHQXLO-UHD / PHQXPO-UHD + PHQXL01-3G / PHQXP01-3G or PHQXL01E-3G / PHQXP01E-3G]

SMPTE Stnds. Link (Content)	Interface	Resolution	Sampling Structure	Pixel Depth	Frame/Field Rate	SDI HDR [†]	SDI SDR
ST 425-3 Annex B.1 (ST 2036-1)	Quad-link HD-SQ	3840 x 2160	4:2:2 (YCbCr)	10	30p, 29.97p, 25p, 24p, 23.98p	○●	○●
ST 425-3 Annex B.1 (ST 2048-1)	Quad-link HD-SQ	4096 x 2160	4:2:2 (YCbCr)	10	30p, 29.97p, 25p, 24p, 23.98p	○●	○●
ST 425-3 Annex B.2, (ST 2036-1)	Dual 3G-B-DS	3840 x 2160	4:2:2 (YCbCr)	10	30p, 29.97p, 25p, 24p, 23.98p	○●	○●
ST 425-3 Annex B.2, (ST 2048-1)	Dual 3G-B-DS	4096 x 2160	4:2:2 (YCbCr)	10	30p, 29.97p, 25p, 24p, 23.98p	○●	○●
ST 2081-10 M1 (ST 2036-1)	6G-2SI	3840 x 2160	4:2:2 (YCbCr)	10	30p, 29.97p, 25p, 24p, 23.98p	○●	○●
ST 2081-10 M1 (ST 2048-1)	6G-2SI	4096 x 2160	4:2:2 (YCbCr)	10	30p, 29.97p, 25p, 24p, 23.98p	○●	○●
ST 425-5 (ST 2036-1)	Quad-link 3G-A, B (1) 2SI	3840 x 2160	4:2:2 (YCbCr)	10	60p, 59.94p, 50p	○●	○●
ST 425-5 (ST 2048-1)	Quad-link 3G-A, B (1) 2SI	4096 x 2160	4:2:2 (YCbCr)	10	60p, 59.94p, 50p, 48p, 47.95p	○●	○●
ST 425-5 (ST 2036-1)	Quad-link 3G-A, B (2) 2SI	3840 x 2160	4:4:4 (YCbCr/RGB)	10	30p, 29.97p, 25p, 24p, 23.98p	○●	○●
ST 425-5 (ST 2048-1)	Quad-link 3G-A, B (2) 2SI	4096 x 2160	4:4:4 (YCbCr/RGB) 4:4:4:4 (YCbCrA/RGBA)	10	30p, 29.97p, 25p, 24p, 23.98p	○●	○●
ST 425-5 (ST 2036-1)	Quad-link 3G-A, B (3) 2SI	3840 x 2160	4:4:4 (YCbCr/RGB)	12	30p, 29.97p, 25p, 24p, 23.98p	○●	○●
ST 425-5 (ST 2048-1)	Quad-link 3G-A, B (3) 2SI	4096 x 2160	4:4:4 (YCbCr/RGB)	12	30p, 29.97p, 25p, 24p, 23.98p	○●	○●
ST 425-5 (ST 2036-1)	Quad-link 3G-A, B (4) 2SI	3840 x 2160	4:2:2 (YCbCr)	12	30p, 29.97p, 25p, 24p, 23.98p	○●	○●
ST 425-5 (ST 2048-1)	Quad-link 3G-A, B (4) 2SI	4096 x 2160	4:2:2 (YCbCr) 4:2:2:4 (YCbCrA)	12	30p, 29.97p, 25p, 24p, 23.98p	○●	○●
ST 425-5 Annex B (ST 2036-1)	Quad-link 3G-A, B (1) SQ	3840 x 2160	4:2:2 (YCbCr)	10	60p, 59.94p, 50p	○●	○●
ST 425-5 Annex B (ST 2048-1)	Quad-link 3G-A, B (1) SQ	4096 x 2160	4:2:2 (YCbCr)	10	60p, 59.94p, 50p, 48p, 47.95p	○●	○●
ST 425-5 Annex B (ST 2036-1)	Quad-link 3G-A, B (2) SQ	3840 x 2160	4:4:4 (YCbCr/RGB)	10	30p, 29.97p, 25p, 24p, 23.98p	○●	○●
ST 425-5 Annex B, (ST 2048-1)	Quad-link 3G-A, B (2) SQ	4096 x 2160	4:4:4 (YCbCr/RGB) 4:4:4:4 (YCbCrA/RGBA)	10	30p, 29.97p, 25p, 24p, 23.98p	○●	○●
ST 425-5 Annex B (ST 2036-1)	Quad-link 3G-A, B (3) SQ	3840 x 2160	4:4:4 (YCbCr/RGB)	12	30p, 29.97p, 25p, 24p, 23.98p	○●	○●
ST 425-5 Annex B, (ST 2048-1)	Quad-link 3G-A, B (3) SQ	4096 x 2160	4:4:4 (YCbCr/RGB)	12	30p, 29.97p, 25p, 24p, 23.98p	○●	○●
ST 425-5 Annex B (ST 2036-1)	Quad-link 3G-A, B (4) SQ	3840 x 2160	4:2:2 (YCbCr)	12	30p, 29.97p, 25p, 24p, 23.98p	○●	○●
ST 425-5 Annex B (ST 2048-1)	Quad-link 3G-A, B (4) SQ	4096 x 2160	4:2:2 (YCbCr) 4:2:2:4 (YCbCrA)	12	30p, 29.97p, 25p, 24p, 23.98p	○●	○●
ST 2081-11 M1, ST 425-5 (ST 2036-1)	Dual-link 6G-2SI (I)	3840 x 2160	4:2:2 (YCbCr)	10	60p, 59.94p, 50p	○●	○●
ST 2081-11 M1, ST 425-5 (ST 2048-1)	Dual-link 6G-2SI (I)	4096 x 2160	4:2:2 (YCbCr)	10	60p, 59.94p, 50p, 48p, 47.95p	○●	○●
ST 2081-11 M1, ST 425-5 (ST 2036-1)	Dual-link 6G-2SI (II)	3840 x 2160	4:4:4 (YCbCr/RGB)	10	30p, 29.97p, 25p, 24p, 23.98p	○●	○●
ST 2081-11 M1, ST 425-5 (ST 2048-1)	Dual-link 6G-2SI (II)	4096 x 2160	4:4:4 (YCbCr/RGB) 4:4:4:4 (YCbCrA/RGBA)	10	30p, 29.97p, 25p, 24p, 23.98p	○●	○●
ST 2081-11 M1 ST 425-5 (ST 2036-1)	Dual-link 6G-2SI (III)	3840 x 2160	4:4:4 (YCbCr/RGB)	12	30p, 29.97p, 25p, 24p, 23.98p	○●	○●
ST 2081-11 M1, ST 425-5 (ST 2048-1)	Dual-link 6G-2SI (III)	4096 x 2160	4:4:4 (YCbCr/RGB)	12	30p, 29.97p, 25p, 24p, 23.98p	○●	○●
ST 2081-11 M1 ST 425-5 (ST 2036-1)	Dual-link 6G-2SI (IV)	3840 x 2160	4:2:2 (YCbCr/RGB)	12	30p, 29.97p, 25p, 24p, 23.98p	○●	○●
ST 2081-11 M1 ST 425-5 (ST 2048-1)	Dual-link 6G-2SI (IV)	4096 x 2160	4:2:2 (YCbCr) 4:2:2:4 (YCbCrA)	12	30p, 29.97p, 25p, 24p, 23.98p	○●	○●
ST 2082-10 M1, ST 425-5 (ST 2036-1)	12G-2SI (I)	3840 x 2160	4:2:2 (YCbCr)	10	60p, 59.94p, 50p	○●	○●
ST 2082-10 M1, ST 425-5 (ST 2048-1)	12G-2SI (I)	4096 x 2160	4:2:2 (YCbCr)	10	60p, 59.94p, 50p, 48p, 47.95p	○●	○●
ST 2082-10 M1 ST 425-5 (ST 2036-1)	12G -2SI (II)	3840 x 2160	4:4:4 (YCbCr/RGB) 4:4:4:4 (YCbCrA/RGBA)	10	30p, 29.97p, 25p, 24p, 23.98p	○●	○●
ST 2082-10 M1 ST 425-5 (ST 2048-1)	12G -2SI (II)	4096 x 2160	4:4:4 (YCbCr/RGB) 4:4:4:4 (YCbCrA/RGBA)	10	30p, 29.97p, 25p, 24p, 23.98p	○●	○●
ST 2082-10 M1 ST 425-5 (ST 2036-1)	12G-2SI (III)	3840 x 2160	4:4:4 (YCbCr/RGB)	12	30p, 29.97p, 25p, 24p, 23.98p	○●	○●
ST 2082-10 M1 ST 425-5 (ST 2048-1)	12G-2SI (III)	4096 x 2160	4:4:4 (YCbCr/RGB)	12	30p, 29.97p, 25p, 24p, 23.98p	○●	○●
ST 2082-10 M1 ST 425-5 (ST 2036-1)	12G-2SI (IV)	3840 x 2160	4:2:2 (YCbCr) 4:2:2:4 (YCbCrA)	12	30p, 29.97p, 25p, 24p, 23.98p	○●	○●
ST 2082-10 M1 ST 425-5 (ST 2048-1)	12G-2SI (IV)	4096 x 2160	4:2:2 (YCbCr) 4:2:2:4 (YCbCrA)	12	30p, 29.97p, 25p, 24p, 23.98p	○●	○●

KEY

○ - Optional

○● - Optional Generator with PHQXLO-GEN / PHQXPO-GEN option and Analyzer

[†] **Note:** Optional HDR formats require PHQXLO-HDR / PHQXPO-HDR

Supported 4K/UHD IP Formats

The following 4K/UHD ST 2110-20 formats are optional with:
PHQXLO-IP-25G and PHQXLO-UHD or
PHQXPO-IP-25G and PHQXPO-UHD.

Resolution	Sampling Structure	Pixel Depth	Frame/Field Rate	2110 HDR†	2110 SDR
3840 x 2160	4:2:2 (YCbCr)	8	60p, 59.94p, 50p, 48p, 47.97p, 30p, 29.97p, 25p, 24p, 23.98p	OA	A
3840 x 2160	4:2:2 (YCbCr)	10	60p, 59.94p, 50p, 48p, 47.97p, 30p, 29.97p, 25p, 24p, 23.98p	O●	●
3840 x 2160	4:2:2 (YCbCr)	12	60p, 59.94p, 50p, 48p, 47.97p, 30p, 29.97p, 25p, 24p, 23.98p	O●	●
3840 x 2160	4:4:4(YCbCr/RGB)	8	30p, 29.97p, 25p, 24p, 23.98p	OA	A
3840 x 2160	4:4:4(YCbCr/RGB)	10	30p, 29.97p, 25p, 24p, 23.98p	O●	●
3840 x 2160	4:4:4(YCbCr/RGB)	12	30p, 29.97p, 25p, 24p, 23.98p	O●	●
4096 x 2160	4:2:2(YCbCr)	8	60p, 59.94p, 50p, 48p, 47.97p, 30p, 29.97p, 25p, 24p, 23.98p	OA	A
4096 x 2160	4:2:2 (YCbCr)	10	60p, 59.94p, 50p, 48p, 47.95p, 30p, 29.97p, 25p, 24p, 23.98p	O●	●
4096 x 2160	4:2:2 (YCbCr)	12	60p, 59.94p, 50p, 48p, 47.95p, 30p, 29.97p, 25p, 24p, 23.98p	O●	●
4096 x 2160	4:4:4(YCbCr/RGB)	8	30p, 29.97p, 25p, 24p, 23.98p	OA	A
4096 x 2160	4:4:4(YCbCr/RGB)	10	30p, 29.97p, 25p, 24p, 23.98p	O●	●
4096 x 2160	4:4:4(YCbCr/RGB)	12	30p, 29.97p, 25p, 24p, 23.98p	O●	●

The following 4K/UHD ST 2110-20 extended formats are optional with:
PHQXLO-IP-25G, PHQXLO-UHD and PHQXLO-EUHD or
PHQXPO-IP-25G, PHQXPO-UHD and PHQXPO-EUHD.

Resolution	Sampling Structure	Pixel Depth	Frame/Field Rate	2110 HDR†	2110 SDR
3840 x 2160	RGB:444	8	60p, 59.94p, 50p, 48p, 47.97p	OA	OA
3840 x 2160	RGB:444	10	60p, 59.94p, 50p, 48p, 47.97p	O●	O●
3840 x 2160	RGB:444	12	60p, 59.94p, 50p, 48p, 47.97p	O●	O●
3840 x 2160	YCbCr:444	8	60p, 59.94p, 50p, 48p, 47.97p	OA	OA
3840 x 2160	YCbCr:444	10	60p, 59.94p, 50p, 48p, 47.97p	O●	O●
3840 x 2160	YCbCr:444	12	60p, 59.94p, 50p, 48p, 47.97p	O●	O●

4K Formats

4096 x 2160	RGB:444	8	60p, 59.94p, 50p, 48p, 47.97p	OA	OA
4096 x 2160	RGB:444	10	60p, 59.94p, 50p, 48p, 47.97p	O●	O●
4096 x 2160	RGB:444	12	60p, 59.94p, 50p, 48p, 47.97p	O●	O●
4096 x 2160	YCbCr:444	8	60p, 59.94p, 50p, 48p, 47.97p	OA	OA
4096 x 2160	YCbCr:444	10	60p, 59.94p, 50p, 48p, 47.97p	O●	O●
4096 x 2160	YCbCr:444	12	60p, 59.94p, 50p, 48p, 47.97p	O●	O●

KEY

- - Generator with PHQXLO-GEN / PHQXPO-GEN option and Analyzer
- O - Optional
- O● - Optional Generator with PHQXLO-GEN / PHQXPO-GEN option and Analyzer
- A - Analyzer Only
- OA - Optional Analyzer

† **Note:** Optional HDR formats require PHQXLO-HDR / PHQXPO-HDR

QxL Dimensions and Installation

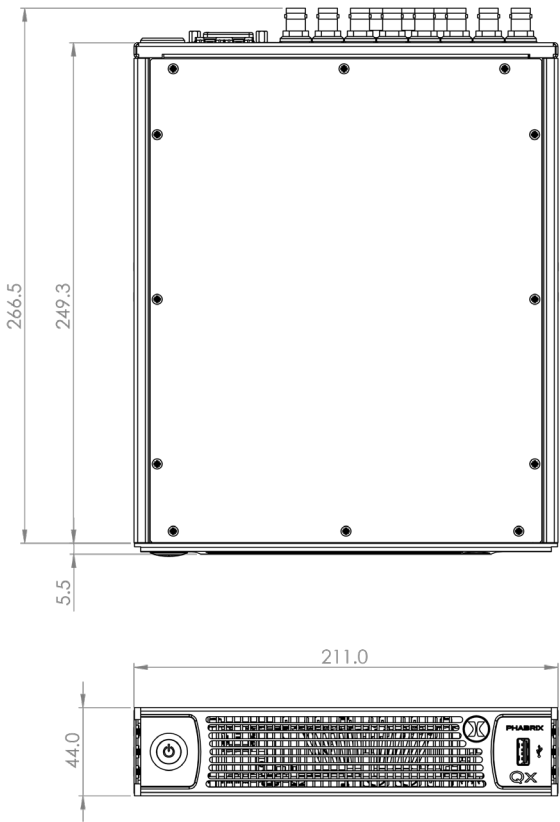

Desktop

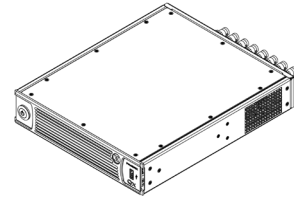

Single Rack mount tray with cover PHQXK1

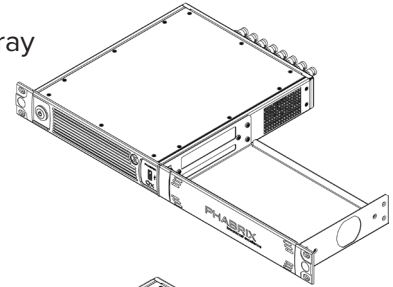

Dual Rack mount PHQXK2

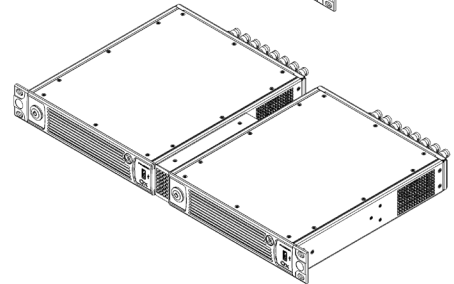

QxP Dimensions

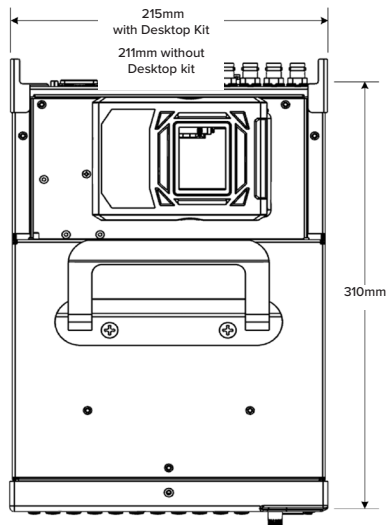

3U 19-inch rackmount kit
PHQXK7 - 1 x QxP Chassis
PHQXK8 - 2 x QxP Chassis

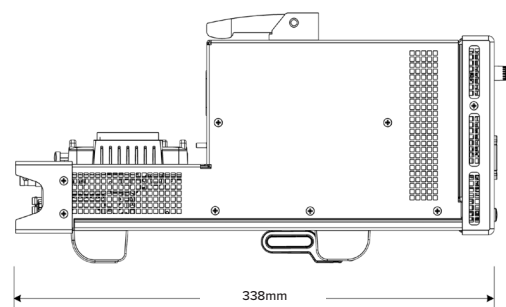
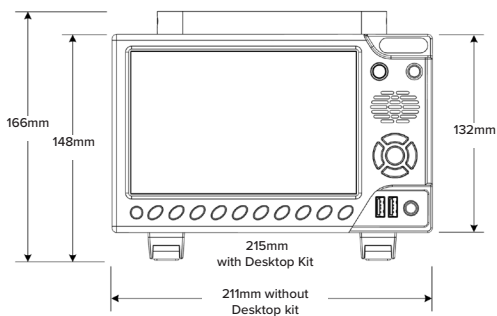
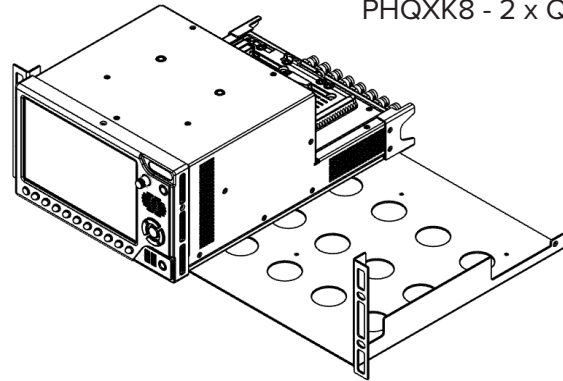



PHABRIX®
A Leader Company

For more information about IP, SDI,
4K/UHD and HDR contact:

www.phabrix.com



This brochure is to be used for informational use only and is subject to change without notice and should not be construed as commitment by PHABRIX. PHABRIX assumes no responsibility or liability for errors or inaccuracies that may appear in this brochure. Please visit www.phabrix.com for latest product information
May 2023