

UNI-T®

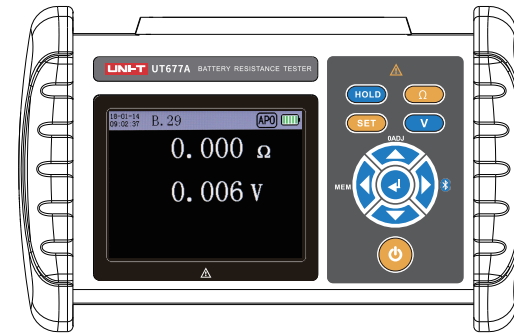

UT677A

Operating Manual

UNI-T®

UNI-TREND TECHNOLOGY (CHINA) CO., LTD.

No.6, Gong Ye Bei 1st Road,
Songshan Lake National High-Tech Industrial
Development Zone, Dongguan City,
Guangdong Province, China
Tel: (86-769) 8572 3888
<http://www.uni-trend.com>
Made in China



BATTERY RESISTANCE TESTER



P/N:110401111108X
2022/04/13 REV.0

CONTENT



CONTENT	- 1 -
I. Safety rules and precautions	- 2 -
II. Introduction	- 2 -
III. Range and accuracy	- 3 -
3.1 Resistance measurement accuracy	- 3 -
3.2 Voltage measurement accuracy	- 3 -
3.3 Temperature measurement accuracy	- 3 -
IV. Technical Specification	- 3 -
V. Structure	- 5 -
VI. Interface display	- 5 -
VII. Measuring principle	- 6 -
7.1 Principle of AC 4-terminal test method	- 6 -
7.2 Principle of voltage measurement	- 6 -
7.3 Principle of temperature measurement	- 6 -
VIII. Operation Method	- 7 -
8.1 Power on/off and automatic shutdown	- 7 -
8.2 Test interface operation	- 7 -
8.3 Setting menu interface operation	- 7 -
8.4 Measurement procedure	- 9 -
8.5 Data storage	- 9 -
8.6 Data access and deletion	- 9 -
8.7 Communication with PC	- 10 -
8.8 Communicate with smartphone or tablet	- 10 -
IX. Maintenance and service	- 10 -
9.1 Battery	- 11 -
9.2 Repair, inspection and cleaning	- 11 -
9.3 Common problem	- 12 -
X. Packing List	- 12 -
Appendix	- 12 -
Appendix 1 Influence of Eddy Current	- 12 -
Appendix 2 Extending the test lead and the influence of induced voltage	- 13 -

I. Safety rules and precautions

Thank you for purchasing our company's universal rechargeable battery internal resistance tester. In order to better use this product, please be sure to:

——Read this user manual in detail.

——Strictly follow the safety rules and precautions listed in this manual.

- ✧ Please pay attention to the +/- polarity of the battery and do not insert it backwards.
- ✧ Do not measure the battery voltage to exceed the upper limit of the meter.
- ✧ The meter displays the symbol "" for low battery voltage, and it should be charged in time, otherwise it will cause measurement errors.
- ✧ When not in use for a long time, fully charge it every three months to ensure that the battery can still be used.
- ✧ This instrument according to IEC61010 safety specifications for design, production, inspection.
- ✧ During measurement, to avoid errors please do not use high-frequency signal generators such as mobile phones near the meter.
- ✧ Pay attention to the label text and symbols on the instrument.
- ✧ Do not place or store the meter for a long time in a place with high temperature, humidity, condensation, or under direct sunlight.
- ✧ Pay attention to the measurement range and use environment specified by this instrument.
- ✧ The use, disassembly, calibration, and maintenance of this instrument must be operated by authorized personnel.
- ✧ Due to the reason of this instrument, if it is dangerous to continue to use it, it should be stopped immediately and sealed up immediately. It is handled by an authorized organization.
- ✧ For the safety warning signs "" in the instrument and the manual, the user must strictly follow the contents of this manual for safe operation.
- ✧ In any case, special attention should be paid to safety when using this instrument.

II. Introduction

General rechargeable battery internal resistance tester, abbreviated as battery internal resistance tester, is a measuring instrument used to measure the internal resistance, voltage and temperature of rechargeable batteries such as lead storage batteries and lithium batteries to determine the health of the battery. It can also be used as a meter to measure the ESR parameters of electrolytic capacitors (for reference only). This meter uses the AC 4-terminal test method to measure the internal resistance of the battery, and can measure the correct measurement value without being affected by the contact resistance between the test wire, terminal and battery electrode. It also has functions such as data storage, data access, alarm, and automatic shutdown. The whole machine is high-grade and beautiful, with wide measuring range, high resolution, convenient operation, easy to carry, accurate, reliable, stable performance, and strong anti-interference ability. It is an indispensable instrument for battery production, battery installation, equipment production, equipment maintenance and other scenarios.

General rechargeable battery internal resistance tester is controlled by a microprocessor, the internal 16-bit ADC can accurately detect battery internal resistance, voltage and temperature. It is characterized by measuring without stopping the UPS system, using AC low-resistance measurement and noise reduction technology, without stopping the normal operation of the device under test, and measuring under the running state, which greatly shortens the test time. At the same time, it has the functions of data storage, histogram display, data upload, computer, mobile phone, tablet and other smart devices Bluetooth connection for wireless measurement

and data access.

III. Range and accuracy

Accuracy guarantee conditions	Accuracy guarantee period: 1 year Accuracy guarantee period after calibration: 1 year Accuracy guaranteed temperature and humidity range: 23°C±5°C, below 80%RH Warm-up time: not required
Temperature characteristics	Add test accuracy 0.1/°C within the operating temperature range (except 18°C~28°C)
Excitation signal accuracy	Measuring current accuracy: ±25% Measuring current frequency: 1.000KHz ± 20Hz (Using multi-stage noise reduction technology to effectively filter out noise interference of different frequencies or near the same frequency)

3.1 Resistance measurement accuracy

Range	Maximum display	Resolution	Test accuracy	Measuring current
3 mΩ	3.100 mΩ	1 uΩ	±1 % fs. ±20 dgt. ±0.5 % fs. ±15 dgt.	200 mA
30 mΩ	31.00 mΩ	10 uΩ		200 mA
300 mΩ	310.0 mΩ	100 uΩ		20 mA
3 Ω	3.100 Ω	1 mΩ		2 mA

3.2 Voltage measurement accuracy

Range	Maximum display	Resolution	Test accuracy
7 V	±7.100 V	1 mV	±0.2 % fs. ±10 dgt.
70 V	±71.00 V	10 mV	

3.3 Temperature measurement accuracy

Range	Maximum display	Resolution	Test accuracy
-10.0°C~60.0°C	60.0°C	0.1°C	±1.0°C

Note: The above accuracy guarantee is limited to the factory standard test leads. When using non-standard test leads or extension cables, this accuracy table is also applicable after zero adjustment.

IV. Technical Specification

Function	Battery internal resistance measurement, battery voltage measurement, temperature measurement
-----------------	---

Accuracy guaranteed temperature and humidity	23°C±5°C, Below 75%rh
Power supply	DC 3.7V lithium battery
Resistance resolution	1 u Ω
Voltage resolution	1 mV
Temperature resolution	0.1°C
Measuring range	Internal resistance measurement: 0.000mΩ~3.100 Ω (4 ranges configuration)
	Voltage measurement: 0.000V~±71.00V (consisting of 2 ranges)
	Temperature measurement: -10.0°C~60.0°C (single range configuration)
Maximum input voltage	DC 70V (between + measurement terminal and-measurement terminal), no AC input
Measurement method	Internal resistance measurement: 1KHz AC 4-terminal test method, open-circuit terminal voltage 3V max Measuring current: 2.0mA~200mA (different measuring currents in different ranges) Temperature measurement: NTC temperature sensor (10KΩ at 26°C) A/D conversion method: successive approximation type Display update frequency: 5 times/second
Response time	200ms
Measure time	About 2 seconds
LCD Size	70.1mm×52.6mm /3.5 inches (320*240 resolution 16-bit true color screen)
Instrument size	190mm×121mm×51mm
USB interface	With a USB interface, the stored data can be uploaded to the computer, saved and printed.
Bluetooth connection	Yes
Hold and store function	Manual retention and storage, automatic retention and storage
Measurement judgment function	Pre-set PASS, WARNING, FAIL judgment thresholds
Battery voltage	The battery level is displayed in 5 bars, reminding to charge in time when the battery voltage is low
Automatic shut-down	No operation when power on, it will power off automatically after about 15 minutes (can be turned off in the settings)
Power consumption	300mA MIN / 500mA MAX
Weight	Meter: 480g (With battery)

Working temperature and humidity	-10°C~40°C; below 80%RH
Storage temperature and humidity	-20°C~60°C; below 70%RH
Insulation resistance	Above 20MΩ (500V between circuit and case)
Withstand voltage	AC 3700V/RMS (between circuit and case)
External magnetic field	<40A/m
External electric field	<1V/m
Standard	IEC 61010

V. Structure

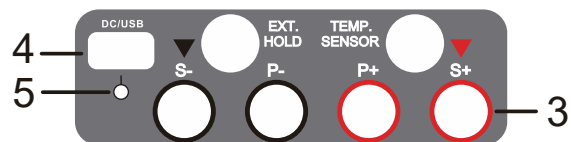



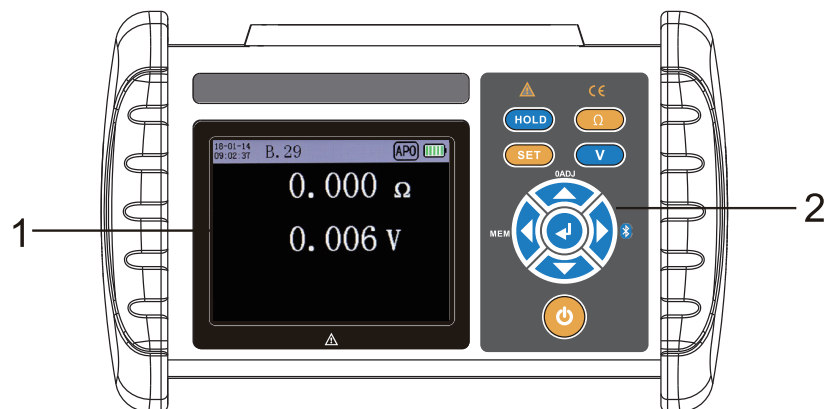



1. Screen
2. Button
3. Wiring port
4. USB/charging port
5. Charging indicator



VI. Interface display

Interface icon and symbol description

	Indicates the remaining power and charging status of the meter battery.
	Indicates that the current instrument has turned on the automatic shutdown function, which is turned on by default.
	Indicates that the current instrument has turned on Bluetooth data, and it is turned off by default.
	Indicates that the instrument has automatically maintained data.
	Indicates that the instrument has manually retained data.
A.21	Indicates that the currently used memory is A, and there are 21 sets of data in A memory.

FULL	If a single memory is full of 500 groups and continues to measure, the screen will display "FULL" and no more data will be stored.
	Indicates that the current measurement result is judged as FAIL failed.
	Indicates that the current measurement result is judged as a WARNING.
	Indicates that the current measurement result is judged as PASS passed.
	Indicates that the current measurement result has subtracted the initial line resistance.
	Indicates that the software filtering function has been turned on, and the digital change is slower than the normal mode, and it is closed by default.
	Indicates that the instrument has turned on the automatic shift function, which is turned on by default.
	Indicates that the current measured voltage has exceeded the safety voltage of the human body, please pay attention to safety.

VII. Measuring principle

7.1 Principle of AC 4-terminal test method

An AC current I with a frequency of 1KHz flows between the positive and negative electrodes of the battery, and the AC voltage difference V between the positive and negative electrodes of the battery is measured, and the internal resistance of the battery is calculated according to the formula $R=V/I$. In order to ensure the measurement accuracy, the two current electrodes (S), the two voltage poles (P) should be in contact with the positive and negative poles of the battery independently, and the correct measurement value can be obtained without wire resistance or contact resistance.

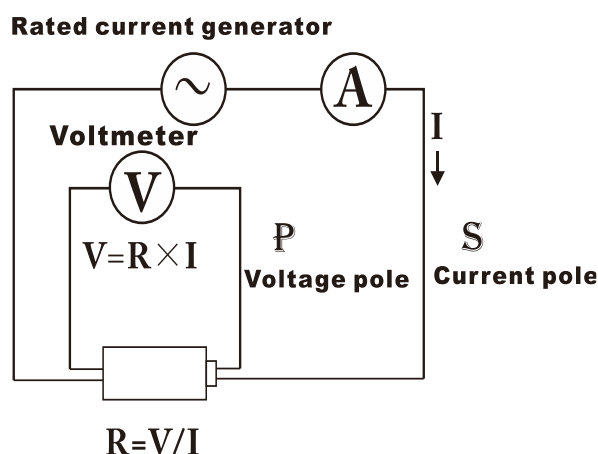

7.2 Principle of voltage measurement

After the sampling resistor divides the pressure and the noise is filtered out, the ADC samples and calculates and corrects to get the measured value through the program.



7.3 Principle of temperature measurement

The voltage divider network is composed of an NTC temperature sensor and R_x , R_x is a

constant, but NTC changes its resistance with temperature changes, and the actual temperature value is obtained by measuring the partial pressure voltage and bringing it into the NTC temperature conversion formula.









VIII. Operation Method

8.1 Power on /off and automatic shutdown

- Press  to power on /off.
- If the automatic shutdown function is turned on, and no key is pressed within 15 minutes after starting up, the meter will automatically shut down to save power. If any key is pressed during the 15-minute timer, it will be extended by another 15 minutes. This function can be turned off in the settings, the factory default is turned on, and  will be displayed when turned on.



8.2 Test interface operation

In the test interface, you can view the current instrument time, measured value, and instrument status information. The functions of the operation buttons are as follows:

	Keep data
	Enter the settings menu
	Resistance measurement shift
	Voltage measurement shift
	Zero or cancel zero
	Turn automatic gear shift on or off
	Enter data reading mode
	Turn Bluetooth on or off
	Turn software filtering on or off





8.3 Setting menu interface operation

Press SET on the test interface to enter the setting directory interface. In the setting directory interface, you can select the items to be set and view the basic information of the instrument.

	Select the item to be set
	Choose to enter



1) Threshold setting

The threshold setting interface can set the thresholds for judging the test results FAIL, WARNING and PASS. Setting an appropriate threshold can improve the efficiency of judgment and test.

	Switch settings
	Enter or exit the current setting item
	Digital displacement
	Addition and subtraction value
	return





2) Alarm settings

The alarm setting interface can set the buzzer prompt mode when the test is completed.

	Select the alarm function
	Save and return
	Return



3) Storage settings

The storage setting interface can be set to maintain, storage mode, memory selection, there are a total of ABCDEFGHIJ ten storage options, if the current memory is full of 500 sets of data, the memory is full (FULL symbol) when storing data, you need to manually set other memory or Only after deleting the current memory data can the new measurement data be stored.

	Select function
	Change settings or select memory
	Choose another storage
	Return





4) Shifting method

Shift mode setting interface can choose manual shift or automatic shift measurement mode. The gear shift mode can also be quickly changed by pressing the ▼ button on the test interface. The icon  on the test interface indicates that the machine has turned on the automatic gear shift function.

	Select function
	Save and return
	Return





5) Clock setting

The clock setting interface can set the time of the instrument. The time display format of this instrument is XX (year)-XX (month)-XX (day) XX (hour): XX (minute): XX (second), or through our company. The supporting software is connected to the computer or mobile phone to synchronize the time of the instrument with one button.

Arrow keys	Select the item to be set
	Set selection items
	Change the value of the selected value
	Check other values
	Effective current setting time
	Return

6) Energy saving settings

The energy-saving setting interface can set the display brightness of the instrument and turn on and off the automatic shutdown function.

	Set selection items
	Change the backlight brightness
	Turn automatic shutdown on or off
	Return

7) About the instrument

You can view the basic information of the current instrument on this page, and press the SET key to return to the setup menu interface.

8.4 Measurement procedure

Internal resistance measurement:

- 1) Connect the test line to the meter, and connect the indication mark (small arrow) of the test line and the indication mark (small arrow) on the machine according to the corresponding color.
- 2) Set the instrument parameters, refer to 8.3.1 and 8.3.2.
- 3) If you use a test line other than the standard configuration, short-circuit the four-wire clamp of the test line, and then press the key  to adjust the zero calibration.
- 4) Clamp the test wire to the electrode of the battery and start the test.
- 5) Wait for the value to stabilize to read the test result.

Voltage measurement:

This meter can also be used as a DC voltmeter. You only need to connect the two red and black ports in the middle to measure the DC voltage. Be careful not to measure the AC voltage or the DC voltage that does not exceed 70V.

Temperature measurement:

Insert the temperature sensor into the TEMP.SENSOR interface, the display interface can display the temperature, and the sensor will not be displayed if it is not connected.



8.5 Data storage

The data storage function needs to turn on the "Keep Storage" function in the settings (please refer to section 8.3.3), and it is turned on by default at the factory. It will automatically number and store a set of data each time manual HOLD or automatic HOLD. This meter has 10 data memories. Numbers A~J can be selected in the settings. When all memories are full, it can store 5000 data records.





It should be noted that when a memory continues to measure after 500 sets are stored, the HOLD data is no longer saved in the memory, and the user needs to manually switch to another memory or delete the memory data before saving.

Memory number	Store records/items
A	500
B	500
C	500
D	500
E	500
F	500
G	500
H	500
I	500
J	500

8.6 Data access and deletion

On the test page, press the key  to enter the reader selection interface, follow the prompts on the page to operate the instrument to select the reader to enter the histogram interface, press the key  on the reader selection interface to delete the current reader data, and you can choose whether to delete it according to the prompts.

As shown in Figure 8-1, each page of the histogram interface can display 10 measurement

records, which can visually analyze the internal resistance of the batch of batteries. You can use the  or  to move the reading cursor left and right. The item selected by the cursor can read the specific information of battery internal resistance, voltage, temperature and test time. You can also use the  or  to scroll through pages.

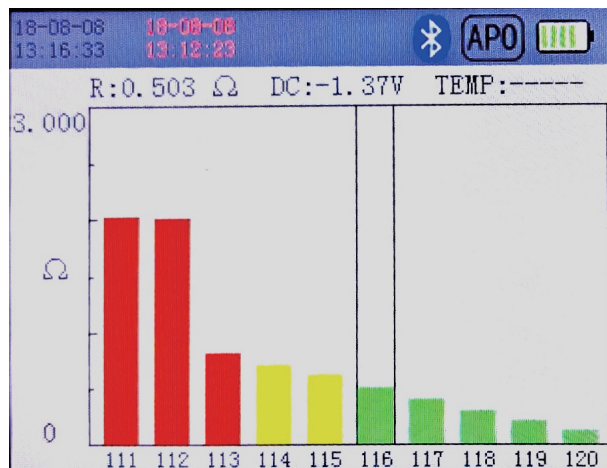

Figure 8-1 Histogram interface

8.7 Communication with PC

Please confirm before use:

1. The USB driver has been installed.
2. EXCEL software is installed in the computer.
3. The host computer software in the CD has been installed.

Use the attached USB cable to connect the instrument to the computer. After opening the software, it will automatically search for the COM port and automatically connect. During this period, it may take a few seconds to ten seconds. After the connection is successful, it can read real-time measurement values, read historical measurement records, synchronize the computer time to the meter and other functions.

8.8 Communicate with smartphone or tablet

Please confirm before use:



1. The phone or tablet system version is Android 5.0 or higher.
2. The "Battery Internal Resistance Tester" APP is installed in the smart device.

In the measurement interface of the meter, press  to turn on the Bluetooth function. The smart phone must also turn on the Bluetooth, and then open the APP. Search for "BRT" (abbreviation of Battery Resistance Tester) and connect. After the connection is successful, functions such as wireless measurement and data browsing can be realized.

IX Maintenance and service

9.1 Battery

- 1) When the battery voltage is too low, the battery symbol "" will flash, and it will be forced to shut down after one minute to protect the battery. Please charge it in time to ensure measurement accuracy.

- 2) Charging is about 5 hours from  to  electric charge. Whether the battery is fully charged depends on the charging indicator. The red light means charging, and the green light means it is fully charged.
- 3) When the battery is fully charged, it can be used continuously for 4 to 8 hours, and the screen brightness and different load power consumption are also different; assuming that the 3Ω range is used all the time and the screen brightness is adjusted to the lowest level, the maximum output current is about 8 hours.
- 4) When the boot screen flashes, the screen goes black. It may be that the battery power is not enough to boot. Please charge it fully before starting the measurement.
- 5) The battery life of the new meter can be charged and discharged about 500 times. When the battery is not durable, you can contact the meter dealer to replace it. Do not replace it yourself.

9.2 Repair, inspection and cleaning

Warning

Please do not modify, disassemble or repair. Otherwise, it may cause fire, electric shock or personal injury. If you disassemble or remodel it yourself, you will be deemed to have given up the one-year free warranty service.

1) Calibration

The calibration cycle varies depending on the customer's usage conditions or environment. It is recommended to determine the calibration cycle according to the customer's use condition or environment, and entrust our company to perform calibration on a regular basis.

2) Clean

When cleaning the instrument, please use a soft cloth dipped in a small amount of water or neutral detergent, and then wipe it gently. Please gently wipe the display area with a dry soft cloth.

Please do not use gasoline, alcohol, acetone, ether, methyl ketone, thinner and detergent containing gasoline. Otherwise it will cause the instrument to be deformed or discolored.

3) Transport

In order to avoid secondary injury caused by impact during transportation, double packaging must be carried out. We do not guarantee the damage caused by transportation.

When returning for repair, please write down the fault content and the return address, contact person, telephone and other necessary information in paper with the instrument and send it back to us.

9.3 Common problem

Question	Answer
Why is the time of the meter inaccurate?	The internal clock system is powered by the battery of the meter, not a button battery. Therefore, the clock system needs to be fully charged to work normally. If it is not used for a long time, it should be charged once every 3 months.
Why does it keep displaying "-----" during measurement?	Please check whether the test line is well connected, and whether the interface is fully plugged in. Generally, "-----" will be displayed when the loop is not connected.
What does it mean to show OL?	The measurement is out of range.

What capacity (Ah) battery internal resistance and voltage can be measured?	This meter uses AC signals for measurement, and DC current does not flow into the meter. Therefore, there is no restriction on the capacity (Ah) of the battery under test.
---	---

X. Packing List

Meter	1 pcs
Test lead	1 set
USB cable	1 pcs
Power adapter	1 pcs
Manual	1 pcs
Instrument box	1 pcs

Note: The monitoring software can be downloaded from Uni-trend official website.

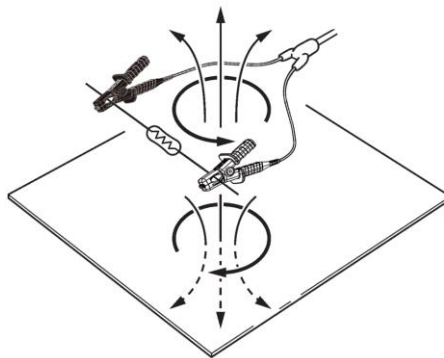

Appendix

Appendix 1 Influence of Eddy Current

The AC current generated by this instrument induces eddy currents on nearby metal plates. Affected by this eddy current, an induced voltage will be induced on the test line. Since the induced voltage and the AC current (reference signal) differ by 180 degrees in phase angle, it cannot be eliminated by synchronous detection, which leads to measurement errors. The influence of eddy current is a phenomenon unique to resistance meters for AC measurement. In order to avoid this effect, do not place metal plates near the test line (where it splits into two strands), and avoid close to metal plates.

Appendix 2 Extending the test lead and the influence of induced voltage

The quality and structure of the test cable have a certain impact on the measurement results. If you need to extend the test cable, please use the test cable recommended by our company.

How to reduce induced voltage

Since this meter uses AC to measure small resistance, it is susceptible to the influence of induced voltage. The induced voltage mentioned here refers to the voltage that the current generated by this instrument affects the signal system through the electromagnetic coupling formed inside the wire.

Since the induced voltage and the AC current (reference signal) have a 90-degree phase angle, when the level is small, it can be completely eliminated by the synchronous detection circuit, but when the level is large, it will cause signal distortion and fail to perform correct synchronous detection. The extension of the test line will increase the induced voltage. Therefore, to reduce the level of the induced voltage, the length of the test line must be shortened as much as possible. Especially shortening the bifurcation into two parts, the effect is better. Even if a standard test lead is used, but in the $3\text{m}\Omega$ range, if the wire configuration changes significantly during the zero adjustment and the range, the measured value will be affected by the induced voltage and produce approximately 20dgt. fluctuations.

The content of this user manual cannot be used as a reason for using the product for special purposes.

The company is not responsible for other losses caused by use.

The company reserves the right to modify the contents of the user manual. If there are changes, no further notice will be given.