

UNI-T®



UT81C Operating Manual

Scope Digital Multimeter



P/N:110401103423
DATE:2018.06.26
REV.2

UNI-T®

**Model UT81C
OPERATING MANUAL**

Table of Contents

Chapter	Title	Page
1	Before You Start	6
	Overview	6
	Unpacking Inspection	7
	Safety Information	8
	Rules For Safe Operation	8
	International Electrical Symbols	10
2	Using The Testing Tool	11
	Reading the screen	11
	The Meter Structure	12
	Functional Buttons	13
3	Making Measurements	15
	A. Scope Mode	15
	i. Setting up the Sleep Mode, Contrast, Beep	15
	ii. ACV, DCV, Hz, ACV and DCA Range	17
	iii. Trigger function	19
	iv. Waveform data save and recall	19
	B. Digital Multimeter Mode	20
	i. Measuring Voltages	20
	ii. Measuring Currents	22
	iii. Measuring Resistance	27
	iv. Testing Diodes	29
	v. Testing for Continuity	31
	vi. Measuring Frequency / Duty Cycle	33

Table of Contents

Chapter	Title	Page
	vii. Measuring Capacitance	35
4	Using Software	37
5	Maintenance The Test Tool	38
	A. General Service	38
	B. Replacing the Fuses	39
	C. Replacing the Battery	40
6	Specifications	41
	Safety and Compliances	41
	Physical Specifications	42
	General Specifications (Digital Multimeter)	43
	General Specifications (Scope)	43
	Feature Summary	44
	Basic Specifications (Digital Multimeter)	44
	Basic Specifications (Scope)	45
	Detailed Accuracy Specifications	45
	A. DC Voltage	46
	B. AC Voltage	46
	C. DC Current	47
	D. AC Current	48
	E. Resistance	49
	F. Diode Test	49
	G. Continuity Test	50

		Table of Contents
Chapter	Title	Page
	H. Frequency and Duty Cycle %	50
	I. Capacitance	51

		List of Tables
Table	Title	Page
1-1	Unpacking Inspection	7
1-2	International Electrical Symbols	10
2-1	Reading the Screen	11
2-2	Functional Buttons	13

List of Tables

Figure	Title	Page
2-1	Meter Structure -----	12
2-2	Functional Buttons -----	13
3-1	Waveform Display -----	17
3-2	Voltages Measurement -----	21
3-3	μ A Range Measurement -----	23
3-4	mA Range Measurement -----	24
3-5	10A Range Measurement -----	25
3-6	Resistance Measurement -----	27
3-7	Diode Test -----	29
3-8	Continuity Test -----	31
3-9	Frequency / Duty Cycle Measurement -----	33
3-10	Capacitance Measurement -----	35
5-1	Fuse Replacement -----	39
5-2	Battery Replacement -----	40

Chapter 1 Before You Start

Overview

This Operating Manual covers information on safety and cautions. Please read the relevant information carefully and observe all the **Warnings** and **Notes** strictly.



Warning

To avoid electric shock or personal injury, read the “Safety Information” and “Rules for Safe Operation” carefully before using the Meter.

Scope Digital Multimeter **UT81C** (hereafter referred to as “the Meter”) is a 3999 counts and 3 3/4 digits adopting digital control technique with both waveform and multimeter all in one.

Scope mode is a complete intelligent measurement system including signal input, sampling, data process, auto search and waveform save and recall. It has

bandwidth UT81C:16MHz real-time sample rate 80MS/s with peak rate sampling process can catch up pulse industrial signal. It can measure AC/DC engine, transducer, circuit, control, UPS and industrial equipments. It is an ideal tools in professional repairing industries.

Digital Multimeter mode can measure AC voltage and current, DC voltage and current, Resistance, Capacitance, Frequency, Duty Cycle, Diodes and Continuity.

Unpacking Inspection

Open the package case and take out the Meter. Check the items shown on Table 1-1 carefully to see any missing or damaged part:

Table 1-1. Unpacking Inspection

Item	Description	Qty
1	English Operating Manual	1 piece
2	USB interface cable	1 piece
3	CD-ROM (Installation Guide & Computer Interface Software)	1 piece
4	Test Lead	1 pair
5	Alligator Clip	1 piece
6	Power Adaptor	1 piece
7	1.5V Batteries (R6)	4 pieces
8	Carrying bag	1 piece
9	Scope Probe (available at extra cost)	1 piece
10	BNC probe (available at extra cost)	1 piece

In the event you find any missing or damage, please contact your dealer immediately.

Safety Information

This Meter complies with the standards IEC61010 safety measurement requirement: in pollution degree 2, overvoltage category (CAT. II 1000V, CAT.III 600V) and double insulation.

CAT.II: Local level, appliance, PORTABLE EQUIPMENT etc., with smaller transient overvoltages than CAT. III
CAT. III: Distribution level, fixed installation, with smaller transient overvoltage than CAT. IV

Use the Meter only as specified in this operating manual, otherwise the protection provided by the Meter may be impaired.

In this manual, a **Warning** identifies conditions and actions that may pose hazards to the user, or may damage the Meter or the equipment under test.

A **Note** identifies the information that user should pay attention to.

International electrical symbols used on the Meter and in this Operating Manual are explained on page 10.

Rules For Safe Operation

Warning

To avoid possible electric shock or personal injury, and to avoid possible damage to the Meter or to the equipment under test, adhere to the following rules:

- **Before using the Meter inspect the case. Do not use the Meter if it is damaged or the case (or part of the case) is removed. Look for cracks or missing plastic. Pay attention to the insulation around the connectors.**
- **Inspect the test leads for damaged insulation or exposed metal. Check the test leads for continuity. Replace damaged test leads with identical model number or electrical specifications before using the Meter.**
- **Do not apply more than the 1000V rms between any terminal and grounding to avoid electric**

shock or damages to the Meter.

- 1 The rotary switch should be placed in the right position and no any changeover of range shall be made during measurement is conducted to prevent damage of the Meter.
- 1 When the Meter working at an effective voltage over 60V in DC or 42V rms in AC, special care should be taken for there is danger of electric shock.
- 1 Use the proper terminals, function, and range for your measurements.
- 1 Do not use or store the Meter in an environment of high temperature, humidity, explosive, inflammable and strong magnetic field. The performance of the Meter may deteriorate after dampened.
- 1 When using the test leads, keep your fingers behind the finger guards.
- 1 Disconnect circuit power and discharge all high-voltage capacitors before testing resistance, continuity, diodes.
- 1 Before measuring current, check the Meter's fuses and turn off power to the circuit before

connecting the Meter to the circuit.











- 1 Replace the battery as soon as the battery indicator  appears. With a low battery, the Meter might produce false readings that can lead to electric shock and personal injury.
- 1 When servicing the Meter, use only the same model number or identical electrical specifications replacement parts.
- 1 The internal circuit of the Meter shall not be altered at will to avoid damage of the Meter and any accident.
- 1 Soft cloth and mild detergent should be used to clean the surface of the Meter when servicing. No abrasive and solvent should be used to prevent the surface of the Meter from corrosion, damage and accident.
- 1 The Meter is suitable for indoor use.
- 1 Turn the Meter off when it is not in use and take out the battery when not using for a long time.
- 1 Constantly check the battery as it may leak when it has been using for some time, replace the battery as soon as leaking appears. A leaking battery will damage the Meter.

- 1 Under the influence of Radiated Radio-Frequency Electromagnetic Field phenomenon, the captioned model have a 20% measurement error, it will be back to normal when the interference is removed.

International Electrical Symbols

Symbols used on the Meter and in this manual are explained in Table1-2.

Table 1-2. International Electrical Symbols

	AC or DC
	DC Measurement
	AC Measurement
	Continuity Test
	Diode
	Grounding
	Double Insulated
	Warning. Refer to the Operating Manual
	Deficiency of Built-In Battery
	Conforms to Standards of European Union

Chapter 2 Using the Testing Tool

Reading the Screen

The screen displays the menu that provides the following choices available:

Table 2-1. Reading the Screen

Display	Description
Contrast	The degree of contrast
Auto Off	Sleep mode time
BK Light	Display backlight
BEEP	Beeper on and off
ENTER	Confirm
▲	Increase
▼	Decrease
MOVE ▲	Waveform moves up
MOVE ▼	Waveform moves down
RANG▲	Increase a range

Table 2-1. Reading the Screen

Display	Description
RANG▼	Decrease a range
BASE ▲	Increase a time base
BASE ▼	Decrease a time base
BASE >	Waveform moves right
BASE <	Waveform moves left
TRIG ▲	Trigger moves up
TRIG ▼	Trigger moves down
SLOP	Trigger slope adjustment
AUTO	Auto trigger mode
NORM	Normal trigger mode
SHOT	Single trigger mode

The Meter Structure

The Figure 2-1 shows the Meter structure.

1. USB Terminals
2. LCD Display
3. Functional Buttons
4. Rotary Switch
5. Power adaptor Input Terminals
6. 10A Input Terminal
7. mA μ A Input Terminals
8. COM Input Terminal
9. Other Input Terminals

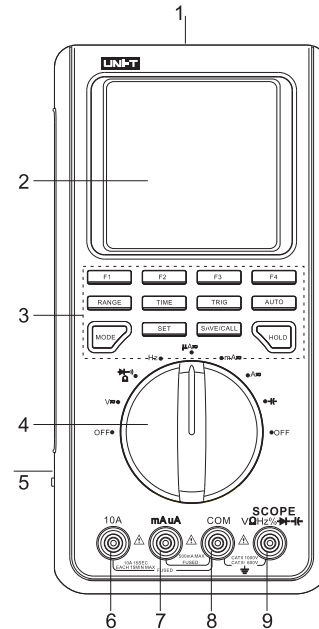

Figure 2-1. Meter Structure

Functional Buttons

The buttons activate features that augment the function selected with the rotary switch. The buttons are shown in Table 2-2.

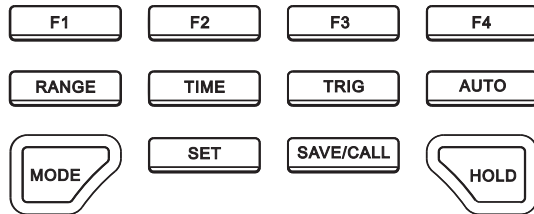

Figure 2-2. Functional Buttons

Table 2-2. Functional Buttons

Buttons	Description
F1, F2, F3 and F4	Software functional buttons, details please refer to the below.
Range	Under scope mode, Press Range button to switch between DC and AC measurement
Time	Under scope mode, press Time button to set the X-axis of time base.
Trig	Under scope mode, press Trig button to change the trigger mode.
Auto	In multimeter mode: Press Auto button to enter autoranging mode when measuring resistance, voltage and current. This button is invalid when measuring capacitance, diode, continuity buzzer and capacitance. In scope mode: Press Auto button to set the amplitude and time base to auto.

Table 2-2. Functional Buttons

Buttons	Description
Mode	To switch between waveform display (scope mode) and digital reading (multimeter mode). This button is only valid when under voltage, frequency, currents mode.
Set	Press Set button to set the auto power off, backlight, contrast and beep
Save/Call	Under scope mode, press Save/Cal to store and recall data.
Hold	Press Hold button to enter or exit hold mode.

Chapter 3 Making Measurement

Introduction

Chapter 3 explains how to make measurements.

You could turn the Meter off by turning to **OFF** position or set up the sleep mode from 1-30 minutes. Please must ensure the Meter is not under sleep mode if you turn the Meter on but without display.

To avoid false readings, which could lead to possible electric shock or personal injury, replace the battery as soon as the battery indicator “” appears.

A. Scope Mode

- The LCD top right part display: RUN, HLD, REV
- The LCD top right corner has battery icon to indicate when the battery is lower than 5V.
- Under scope mode, both reading and waveform will be displayed.

i. Setting up Sleep Mode, Contrast, Beep

Based on the working environment to set up sleep mode, contrast, beep

Press **Set** button to set the auto power off, display backlight, contrast and beep

Auto off	Bk Light	Contrast	Beep
F1	F2	F3	F4

F1: Set auto power off time

Auto off	▲	15	▼	ENTER
F1	F2	F3	F4	

The time level is from OFF, 1 to 30 minutes. Press F4 to confirm, save and return. Press functional button to exit and the setting remains unchanged.

F2: Set the Display Backlight

BK Light ▲ **15** ▼ **ENTER**

F1 F2 F3 F4

The brightness level from 0 to 31. Press F4 to confirm, save and return. Press functional buttons to exit, the setting is kept, but will not save. The setting will be lost after power off.

F3: Set the LCD contrast

Contrast ▲ **15** ▼ **ENTER**

F1 F2 F3 F4

The contrast level from 0 to 31. Press F4 to confirm, save and return. Press functional buttons to exit, the setting is kept, but will not save. The setting will be lost after power off.

F4: Set the beeps features, it can only be used under resistance, diode and continuity measurement.

Beep **ON** **OFF** **ENTER**

F1 F2 F3 F4

F2 : to turn the beep on

F3 : to turn the beep off

F4 : to confirm , save and return

Press functional buttons to exit, the setting is kept, but will not save. The setting will be lost after power off.

Model UT81C: OPERATING MANUAL

ii. ACV, DCV, Hz, ACA and DCA range

Turn the rotary switch to ACV, DCV, Hz, ACA or DCA range, the Meter displays digital reading (Multimeter mode). Press **Mode** to switch to waveform display (scope mode) as below Figure 4. When entering scope mode, time base is auto trace, the amplitude is manual set, you may need to re-set them. You could set the trigger level as well if it is needed. Details of measurement operation of ACV, DC, Hz, ACA or DCA can be seen from B. Digital Multimeter Mode:

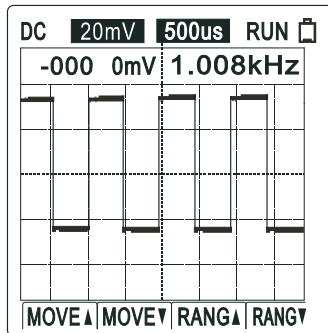

Figure 3-1. Waveform Display

- Press **Range** to switch between DC and AC measurement.
- When the frequency and amplitude of a waveform is unknown, press **Auto** :
 - When the amplitude is set to auto, the amplitude indicator will be shown white text in black background. When the amplitude is set to manual, the amplitude indicator will be shown black text in white background.
 - When the time base is set to auto, the time base indicator will be shown white text in black background. When the time base is set to manual trace, the time base indicator will be shown black text in white background.
 - When the time base is between 20ms - 100ns, it is possible to set the auto. When the time base is between 50ms - 5s, the auto feature will be in valid.

- Y-axis adjustment: Press **Range** button under scope mode, the corresponding functional button:

Move ▲ **Move** ▼ **Rang** ▲ **Rang** ▼
F1 F2 F3 F4

F1: move up the waveform
F2: move down the waveform
F3: go up range
F4: go down a range

The auto set feature will be off when changing the measurement mode

- Press **Time** button under scope mode, the corresponding functional button:

Base ▲ **Base** ▼ **Base <** **Base >**
F1 F2 F3 F4

F1: increase the number of periods
F2: decrease the number of periods.
F3: trigger point move left
F4: trigger point right move

The auto set feature will be off when changing the measurement mode.

iii. Trigger function

Press **Trig** button under scope mode, the corresponding function buttons:

Trig ▲ Trig ▼ Auto/Norm/Shot Slop Rise/Fall
 F1 F2 F3 F4

- F1: move the trigger level up
- F2: move the trigger level down
- F3: select the trigger mode: auto, normal or single
- F4: slope adjustment: rise or fall

iv. Waveform data save and recall

Press **Save/Call** button under scope mode, the corresponding functional buttons:

Save/Call ▲ 1 ▼ Enter
 F1 F2 F3 F4

- F1: save or recall
- F2 and F3: select location (location from 0-9, total

10 location)

F4: confirm

- When saving the data, it will overwrite the current data in the location no matter that location has data or not.
- If you recall the location has no data, the meter will appear error message, you need to press **HOLD** button to continue measurement,
- If you recall the location has data, it will save the current setting and display the data, the LCD top left shows **REV** to indicate recalling mode is on. Press **HOLD** button to return to working mode and continue measurement. You could continue recalling under recall mode or save the data.
- Recall mode can be used under any scope mode. For example, it is possible to recall the waveform or data saved from voltage or frequency mode when the meter is under current measurement mode.
- Recall mode can be worked under any waveform mode. For example: the Meter is at current mode but recalling the waveform or data which are saved under voltage or frequency mode. The Meter must

be returned to working mode to carry out measurement.

Remarks:

In order to have more accurate waveform, user can buy an optional BNC probe and scope probe to decrease signal attenuates. The scope probe directly connect to the BNC probe.

When measuring voltage and frequency signal, connect the BNC black probe to the COM input terminal and the red probe to the voltage terminal.

When measuring current signal, connect BNC black probe to the COM terminal and the red probe to mA terminal.

Don't connect the BNC probe to the 10A terminal.

B. Digital Multimeter Mode

i. Measuring Voltages



To avoid harms to you or damages to the Meter from electric shock, please do not attempt to measure voltages higher than DC 1000V, AC 750V, although readings may be obtained.

To measure voltages, set up the Meter as Figure 3-2 and do the following:

1. Insert the red test lead into the **V** terminal and the black test lead into the **COM** terminal.
2. Set the rotary switch to **V** .
3. Connect test leads across with the object being measured.
4. The measured value shows on the display.
5. Press **MODE** button to toggle between Multimeter mode and Scope mode.
6. Press F1 to toggle between AC and DC voltage measurement.

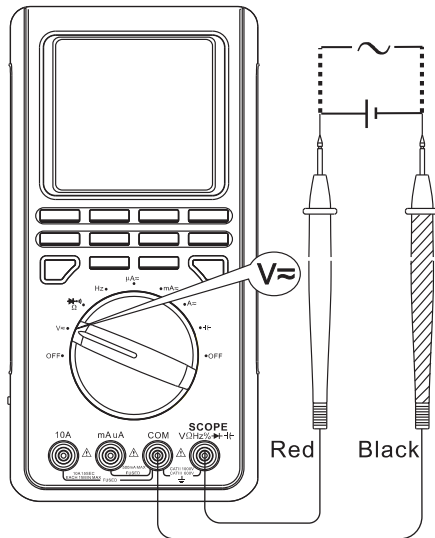

Figure 3-2. Voltages Measurement

When measuring voltage, the corresponding functional buttons

AC / DC	REL	Rang ▲	Rang ▼
F1	F2	F3	F4

- F1: toggle between AC or DC
- F2: relative mode (REL will be displayed at the right bottom of the LCD when it is on)
- F3: select a range up
- F4: select a range down

Note:

- After changing the measurement mode, the autoranging will be off automatically and the AUTO will be disappeared at the bottom left of the LCD.
- When voltage measurement has been completed, disconnect the connection between the testing leads and the circuit under test and remove testing leads away from the input terminals of the Meter.

II. Measuring Currents

Warning

If the fuse burns out during measurement, the Meter may be damaged or the operator himself may be hurt.

To avoid possible damage to the Meter or to the equipment under test, check the Meter's fuses before measuring current. Use proper terminals, function, and range for the measurement. Never place the testing leads in parallel with any circuit or component when the leads are plugged into the current terminals.

Turn off power to the circuit before test leads are connected in series to the return circuit to be tested.

Model UT81C: OPERATING MANUAL

- μA Range Measurement

To measure AC μA or DC μA currents, set up the Meter as Figure 3-3 and proceed as follows:

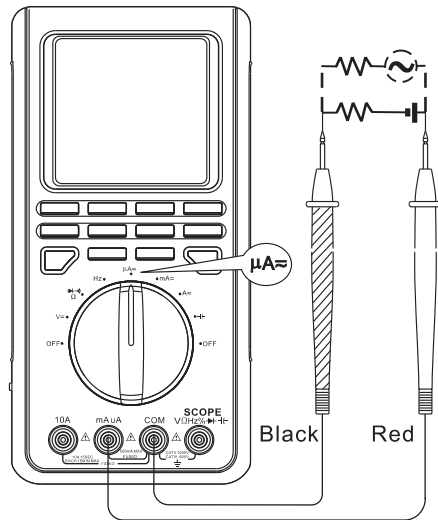

Figure 3-3. μA Range Measurement

1. Insert the red test lead into the μmA terminal and black test lead into the **COM** terminal.
2. Set the rotary switch to μA .
3. Connect the test lead in series with the return circuit to be tested.
4. The measured value shows on the display.
5. Press **MODE** button to toggle between Multimeter mode and Scope mode.
6. Press F1 to toggle between AC and DC current measurement.

● mA Range Measurement

To measure ACmA or DcmA currents, set up the Meter as Figure 3-4 and proceed as follows:

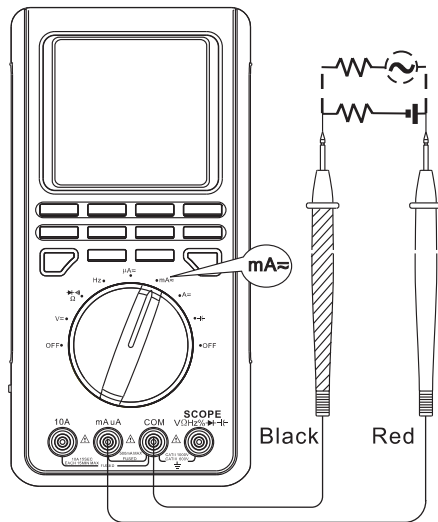

Figure 3-4. mA Range Measurement

1. Insert the red test lead into the μmA terminal and black test lead into the **COM** terminal.
2. Set the rotary switch to **mA**.
3. Connect the test lead in series with the return circuit to be tested.
4. The measured value shows on the display.
5. Press **MODE** button to toggle between Multimeter mode and Scope mode.
6. Press **F1** to toggle between AC and DC current measurement.

Model UT81C: OPERATING MANUAL

- 10A Range Measurement

To measure AC 10A or DC 10A currents, set up the Meter as Figure 3-5 and proceed as follows:

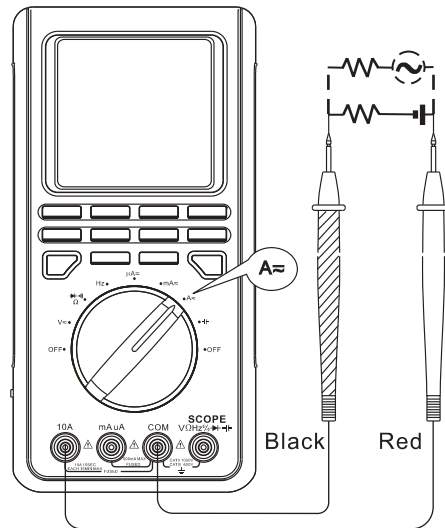

Figure 3-5. 10A Range Measurement

1. Insert the red test lead into the **10A** terminal and black test lead into the **COM** terminal.
2. Set the rotary switch to **A~**.
3. Connect the test lead in series with the return circuit to be tested.
4. The measured value shows on the display.
5. Press **MODE** button to toggle between Multimeter mode and Scope mode.
6. Press **F1** to toggle between AC and DC current measurement.

When measuring current, the corresponding functional buttons:



- F1: toggle between AC or DC
- F2: relative mode (REL will be displayed at the right bottom of the LCD when it is on)
- F3: select a range up
- F4: select a range down

Note

- After changing the measurement mode, the autoranging will be off automatically and the AUTO will be disappeared at the bottom left of the LCD.
- If the value to be measured is unknown, use the maximum measurement position and reduce the range step by step until a satisfactory reading is obtained.
- When the measured current is $\leq 5A$, continuous measurement is allowed.
- When the measured current is between 5A-10A, continuous measurement ≤ 10 seconds and interval more than 15 minutes.
- When current measurement has been completed, disconnect the connection between the testing leads and the circuit under test and remove testing leads away from the input terminals of the Meter.

iii. Measuring Resistance

Warning

To avoid possible damages to the Meter or to the devices under test, disconnect circuit power and discharge all the high-voltage capacitors before measuring resistance.

To measure resistance, set up the Meter as shown in Figure 3-6 and follow the following procedure:

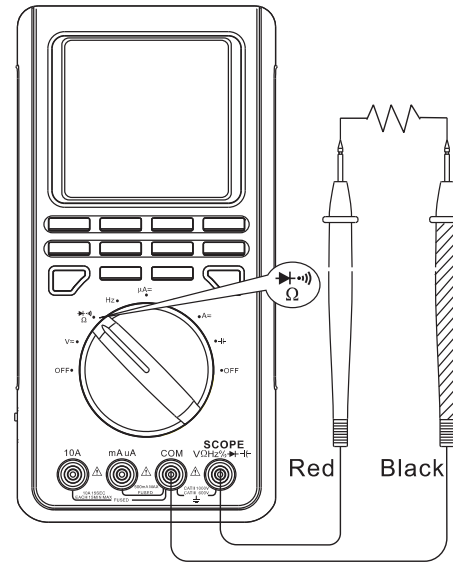

Figure 3-6. Resistance Measurement

1. Insert the red test lead into the Ω terminal and the black test lead into the COM terminal.
2. Set the rotary switch to $\Omega \cdot \text{)} \rightarrow$
3. Connect the test leads across with the object being measured.
4. The measured value shows on the display.

When measuring resistance, the corresponding functional buttons:



- F1: toggle to diode mode
F2: relative mode
F3: select to a range up
F4: select to a range down

Note

- When measuring low resistance, the test leads can add 0.1 Ω to 0.2 Ω of error to resistance measurement. To test the leads, touch the probe tips together and read the resistance of the leads. Take the reading obtained to subtract the resistance of the leads to get the final reading.
- For high-resistance measurement (>1M Ω) or low resistance measurement (<40 Ω), it is normal taking several seconds to obtain a stable reading.
- The LCD displays "OL" indicating open-circuit without input.
- When resistance measurement has been completed, disconnect the connection between the testing leads and the circuit under test and remove testing leads away from the input terminals.

iv. Testing Diodes

Warning

To avoid harms to you, please do not attempt to input voltages higher than 60V DC or 42V rms AC.

To avoid damages to the Meter or to the devices under test, disconnect circuit power and discharge all the high-voltage capacitors before testing diodes.

Use the diode test to check diodes, transistors, and other semiconductor devices. The diode test sends a current through the semiconductor junction, then measure the voltage drop across the junction. A good silicon junction drops between 0.5V and 0.8V

To test the diode out of a circuit, set up the Meter as Figure 3-7 and proceed as follows:

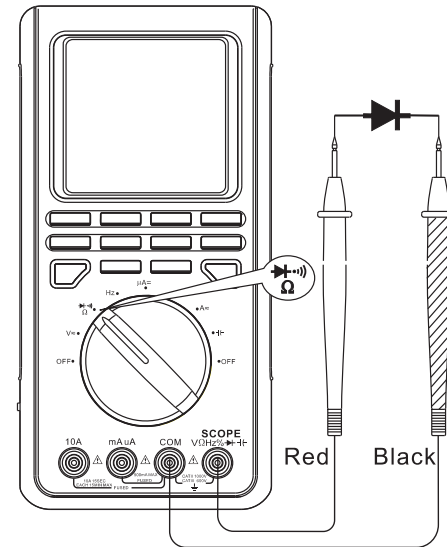

Figure 3-7. Diode Test

1. Insert the red test lead into the Ω terminal and the black test lead into the **COM** terminal.
2. Set the rotary switch to $\Omega \cdot \text{V}$ \rightarrow \rightarrow .
3. For forward voltage drop readings on any semiconductor component, place the red test lead on the component's anode and place the black test lead on the component's cathode. The red test lead polarity is "+" while the black test lead polarity is "-".

The measured value shows on the display.

When measuring diode, the corresponding functional buttons:

DIODE **REL**

F1

F2

F1: toggle to continuity buzzer

F2: relative mode

Note

- Connect the test leads to the proper terminals as said above to avoid error display.
- The LCD will display **OL** indicating either open circuit or wrong polarity connection.
- The unit of diode is volt (V), displaying the positive-connection voltage-drop value.
- When diode testing has been completed, disconnect the connection between the testing leads and the circuit under test and remove the test leads away from the input terminals.

v. *Testing for Continuity*

Warning

To avoid harms to you, please do not attempt to input voltage higher than 60V DC or 42V rms AC.

To avoid possible damages to the Meter or to the devices under test, disconnect circuit power and discharge all the high-voltage capacitors before measuring continuity.

To test for continuity, set up the Meter as Figure 3-8 and do the following:

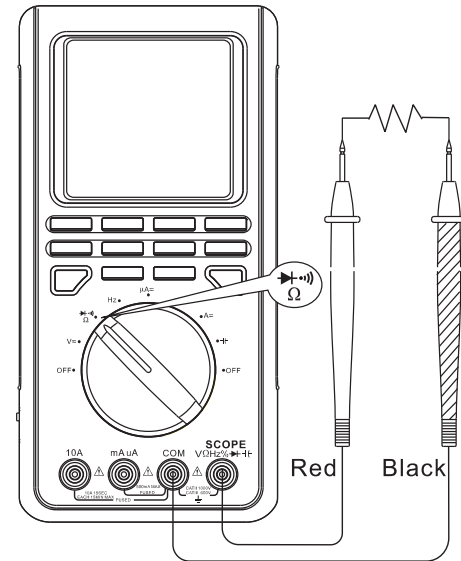

Figure 3-8. Continuity Test

1. Insert the red test lead into the W terminal and the black test lead into the **COM** terminal.
2. Set the rotary switch to $\Omega \cdot \mu \text{A}$.
3. Connect the test leads across with the object being tested.
4. The tested circuit overload resistance value shows on the display.
5. The beeper comes on continuously for open conditions, that is test resistance $<10W$.
6. The beeper does not sound when the test resistance is $>100W$

When measuring continuity buzzer, the corresponding functional buttons:



- F1: toggle to resistance measurement mode
F2: relative mode

Note

- When continuity testing has been completed, disconnect the connection between the testing leads and the circuit under test and remove the test leads away from the input terminals.

Model UT81C: OPERATING MANUAL

vi. Measuring Frequency / Duty Cycle



Warning

To avoid harms to you, please do not attempt to input voltage higher than 42V rms.

To measure frequency and duty cycle, connect the Meter as Figure 3-9 and do the following:

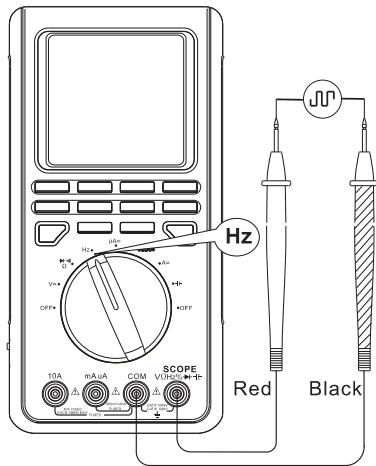

Figure 3-9. Measuring Frequency / Duty Cycle

1. Insert the red test lead into the **Hz** terminal and the black test lead into the **COM** terminal.
2. Set the rotary switch to Hz.
3. Connect the test leads across with the object being measured.
4. The measured value shows on the display.
5. Press **MODE** button to toggle between Multimeter mode and Scope mode.
6. Press F1 to toggle between frequency and duty cycle measurement.

When measuring frequency and duty cycle, the corresponding functional buttons:

Freq/Duty

F1

F1: toggle between frequency and duty cycle

Note

- The requirement of Input amplitude “a” is as follows:
When $\leq 1\text{MHz}$: $300\text{ mV} \leq a \leq 30\text{Vrms}$;
 $>1\text{MHz}$: $600\text{ mV} \leq a \leq 5\text{Vrms}$
- It is normal to have few seconds run time when switch from other functions to these functions.
- When Hz or duty cycle measurement has been completed, disconnect the connection between the testing leads and the circuit under test and remove the test leads away from the input terminals.

vii. Measuring Capacitance

Warning

To ensure accuracy, the Meter inside is discharged against the tested capacitor

To avoid damage to the Meter or to the equipment under test, disconnect circuit power and discharge all high-voltage capacitors before measuring capacitance.

To measure capacitance, set up the Meter as shown in Figure 3-10 and proceed as follows:

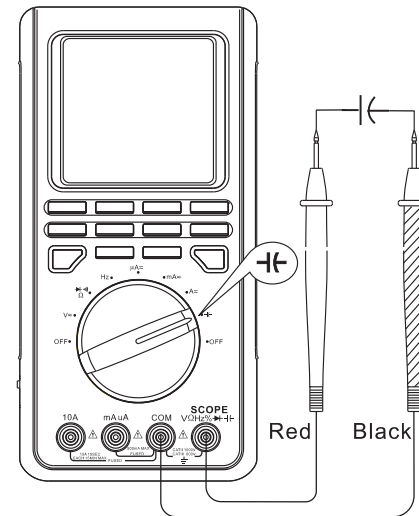

Figure 3-10. Measuring Capacitance

1. Insert the red test lead into **V** terminal and the black test lead into the COM terminal.
2. Set the rotary switch to **V** measurement mode, the Meter may display a fixed reading which is an internal distributed capacitor value. For testing less than 40nF capacitor, the tested value must subtract the internal distributed capacitor value to maintain the accuracy.
3. To improve the accuracy, press F2 REL with the test leads open to subtract the residual capacitance of the Meter and the test leads.
4. It is recommended to use as short as test lead carrying out measurement to reduce the effect of internal distributed capacitor.

When measuring capacitance, the corresponding functional buttons:

Capacity	REL
F1	F2

F2: relative mode

Note

- Capacitors larger than 10 μ F take longer time.
- If the tested capacitor has polarity, connect the red test lead to positive side and black test lead to negative side.
- When capacitance measurement has been completed, disconnect the connection between the testing leads and the circuit under test and remove the test leads away from the input terminals of the Meter.

Chapter 4 Using Software

When using the Software, please refer to the Installation Guide of the included CD-ROM.

Chapter 5 Maintaining The Test Tool

This chapter provides basic maintenance information including battery and fuse replacement instruction.

Warning

Do not attempt to repair or service your Meter unless you are qualified to do so and have the relevant calibration, performance test, and service information.

A. General Service

- 1 Periodically wipe the case with a damp cloth and mild detergent. Do not use abrasives or solvents.
- 1 To clean the terminals with cotton bar with detergent, as dirt or moisture in the terminals can affect readings.
- 1 Turn the Meter to **OFF** when it is not in use.
- 1 Take out the battery when it is not using for a long time.
- 1 Do not use or store the Meter in a place of humidity,

high temperature, explosive, inflammable and strong magnetic field.

B. Replacing the Fuses

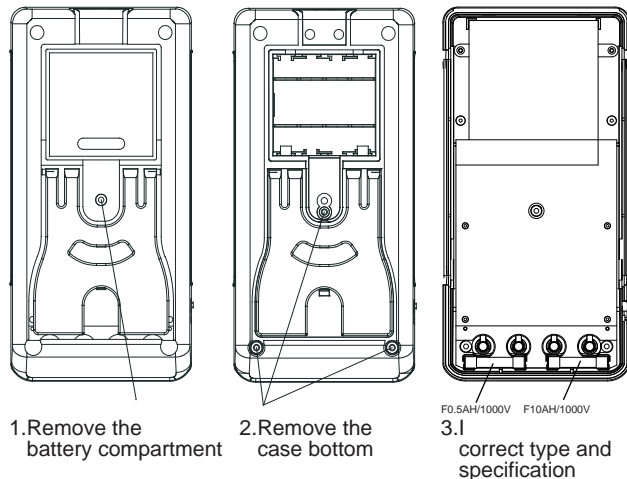

Figure 5-1. Fuse Replacement

Warning

To avoid electrical shock or arc blast, or personal injury or damage to the Meter, use specified fuses ONLY in accordance with the following procedure.

Follow Figure 5-1 and proceed as follows to replace the Meter's fuse:

- 1 Turn the rotary switch to **OFF** and remove all connections from the terminals.
- 1 Remove the screw from the battery compartment, and separate the battery compartment from the case bottom.
- 1 Remove the three screws from the case bottom, and separate the case bottom from the case top.
- 1 Remove the fuse by gently prying one end loose, then take out the fuse from its bracket.
- 1 Install **ONLY** replacement fuses with the identical type and specification as follows and make sure the fuse is fixed firmly in the bracket.
 - Fuse 1: F0.5AH/1000V, $\varnothing 6 \times 32$ mm
 - Fuse 2: F10AH/1000V, $\varnothing 6 \times 32$ mm
- 1 Rejoin the case bottom and case top, battery compartment and case bottom, and install the 5 screws.

Replacement of the fuses is seldom required. Burning of a fuse always results from improper operation.

C. Replacing the Battery

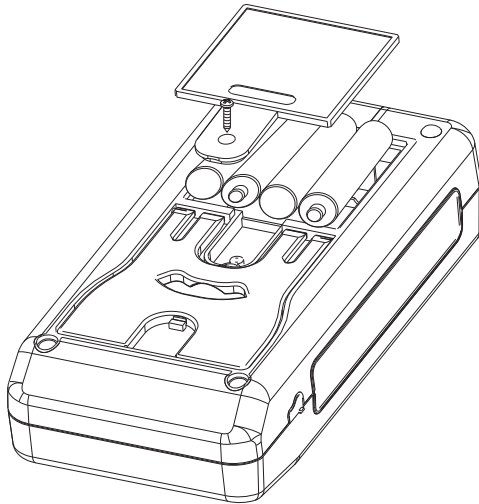



Figure 5-2. Battery Replacement

Warning

To avoid false readings, which could lead to possible electric shock or personal injury, replace the battery as soon as the battery indicator “” appears.



Make sure the test leads are disconnected from the circuit being tested before opening the case bottom.

Follow Figure 5-2 and proceed as follows to replace the battery:

- Turn the rotary switch to OFF and remove all connections from the terminals.
- Remove the screw from the battery compartment, and separate the battery compartment from the case bottom.
- Replace with 4 pieces new 1.5V (R6P) batteries.
- Rejoin the case bottom and battery compartment, and reinstall the screw.

Chapter 6 Specifications

Safety and Compliances

Maximum Voltage between any Terminal and Grounding	Refer to different range input protection voltage
Certification	CE
Compliances	IEC 61010 CAT. II 1000V, CAT.III 600V overvoltage and double insulation standard
 Fused Protection for mA input terminal:	F0.5AH/1000V, ø6x32mm
 Fused Protection for 10A input terminal:	F10AH/1000V, ø6x32mm

Physical Specifications

Display (LCD)	Digital: 3999 counts on display ; updates 2-3 times / second.
Operating Temperature	0°C~40°C (32°F~104°F)
Storage Temperature	-10°C~50°C (14°F~122°F)
Relative Humidity	≤ 75% @ 0°C~40°C; ≤ 0% @ -10°C~50°C.
Altitude	2000m;
Battery Type	1.5V (R6) x 4 Batteries or Power adaptor. Check carefully about the working voltage of power adaptor before use.
Electromagnetic Compatibility	1 In a radio field of 1 V/m below: Overall Accuracy = Specified Accuracy + 5% of Range 1 In a radio field of 1 V/m above: No assigned accuracy is specified.
Dimensions (H x W x L)	200 x 100 x 48mm.
Weight	Approx. 498g (including battery)

General Specifications (Digital Multimeter)

Range	When it is under Multimeter mode, you could select either auto or manual ranging.
Polarity	Auto, negative polarity displays “-“
Overloading	Display OL
Battery Deficiency	Display 

General Specifications (Scope)

Display	160 x 160 Monochrome
Auto setting	Auto set the Meter according to the tested signal size
Overloading	Display OL
Memory	10 screens and setups
USB	Optically isolated to ensure safety
Tilt Stand	Allowing viewing at a convenient position and angle.

Feature Summary

Display	160 x 160 Monochrome
Autorange	When it is under multimeter mode, the Meter automatically selects best range
Continuity	Beeper sounds for resistance readings below threshold.
Duty Cycle	Measure signal on or off time in %.
Battery Access Door	Battery replaceable.

Basic Specifications (Digital Multimeter)

Function	Ranges / Description
DC Voltage	0 to 1000V
AC Voltage	0 to 750V
Basic Accuracy	DC Voltage: 0.8% AC Voltage: 1%
DC Current	0 to 10A
AC Current	0 to 10A
Resistance	0 to 40MΩ
Capacitance	0 to 100μF
Frequency	0~10MHz

Basic Specifications (Scope)

Horizontal		Vertical	
	UT81C 80M per second	Bandwidth	UT81C:16MHz
Sampling rate		Channel	Single
Sampling rate / Scale	20 pixels	Coupling	DC
Updating rate	>5	Voltage resolution	8 Bits
Trigger types	Free Run / Normal / Single Shot	Input Impedance	10MΩ (excluding Multimeter part)
Timebase Range	UT81C 50ns/div~5 sec /div (1-2-5)	Accuracy	±(5%+1pix)
Timebase accuracy	±(0.1% + 1pix)	Maximum input voltage	1000Vp-p
		Voltage Sensitivity	20mV/div~500V/div (1-2-5)

Detailed Accuracy Specifications

Accuracy: ±([% of reading] + [number of least significant digits]), guarantee for 1 year.

Operating temperature: 18°C~28°C

Relative humidity: <75%RH

A. DC Voltage

Range	Resolution	Accuracy	Overload Protection	Input Impedance
400mV	100μV	±(0.8%+8)	1000V DC or AC	Around 10MΩ (excluding waveform)
4V	1mV			
40V	10mV			
400V	100mV			
1000V	1V	±(1%+8)		

B. AC Voltage

i. Under Multimeter mode

Range	Resolution	Accuracy	Overload Protection	Input Impedance
4V	1mV	±(1%+15)	1000V DC or AC	Around 10MΩ (excluding waveform)
40V	10mV			
400V	100mV			
750V	1V	±(1.2%+15)		

Remarks:

- Frequency Response: 40Hz ~ 400Hz
- Displays effective value of sine wave (mean value response).

ii. Under Scope mode

- The specification is same as **Bi Under Multimeter mode**.
- On the top right corner of the display shows the accuracy of the frequency which is around $\pm 2\%$. When the LCD displays 1-10 period waveform, the reading is valid, otherwise the Meter displays " -- "

C. DC Current

Range	Resolution	Accuracy	Overload Protection
400 μ A	0.1 μ A	$\pm(1\%+8)$	F0.5AH/1000V, $\varnothing 6 \times 32$ mm
4000 μ A	1 μ A		
40mA	10 μ A	$\pm(1.2\%+8)$	
400mA	100 μ A		
4A	1mA	$\pm(1.5\%+8)$	F10AH/1000V, $\varnothing 6 \times 32$ mm (Continuous measurement ≤ 10 seconds and interval more than 15 minutes.)
10A	10mA		

D. AC Current

i. Under Multimeter mode

Range	Resolution	Accuracy	Overload Protection
400μA	0.1μA	±(1.5%+8)	F0.5AH/1000V, ø6×32mm
4000μA	1μA		
40mA	10μA	±(2%+8)	
400mA	100μA		
4A	1mA	±(2.5%+5)	F10AH/1000V, ø6×32mm (Continuous measurement ≤10 seconds and interval more than 15 minutes.)
10A	10mA		

Remarks:

- Frequency Response: 40Hz~400Hz.
- Displays effective value of sine wave (mean value response).

ii. Under Scope mode

- The specification is same as **Di Under Multimeter mode.**

On the top right corner of the display shows the accuracy of the frequency which is around $\pm 2\%$. When the LCD displays 1-10 period waveform, the reading is valid, otherwise the Meter displays " ---- "

E. Resistance

Range	Resolution	Accuracy	Overload Protection
400 Ω	0.1 Ω	$\pm(1.2\%+5)$	250VDC or AC rms
4k Ω	1 Ω	$\pm(1\%+5)$	
40k Ω	10 Ω		
400k Ω	100 Ω		
4M Ω	1k Ω	$\pm(1.2\%+5)$	
40M Ω	10k Ω	$\pm(1.5\%+5)$	

F. Diode Test

Range	Resolution	Overload Protection	Remarks
	1mV	250V DC or AC	A good silicon junction drops between 0.5V and 0.8V.

G. Continuity Test Test

Range	Resolution	Overload Protection	Remarks
•)	0.1Ω	750V DC or AC	1 The buzzer sounds when the test resistance is $\leq 10\Omega$. 1 The buzzer does not sound when the test resistance is $>100\Omega$.

H. Frequency and Duty Cycle %

i. Under Multimeter mode

Range	Resolution	Accuracy	Overload Protection
10Hz~10MHz	0.001Hz	$\pm(0.1\%+3)$	250V DC or AC rms
0.1%~99.9%	0.1%	Reading for reference only	

Remarks:

- Input amplitude "a" as follows; (DC electric level is zero)
 When $\leq 1\text{MHz}$: $300\text{mV} \leq a \leq 30\text{Vrms}$;
 When $>1\text{MHz}$: $600\text{mV} \leq a \leq 5\text{Vrms}$

ii. Under Scope mode

- The specification is same as **Hi. Under Multimeter mode**, press **RANGE** button to toggle between frequency and duty cycle mode.
- On the top right corner of the display shows the waveform's RMS value, for reference only. When the LCD displays 1-10 period waveform cycle or the peak-peak difference value is greater than 1/3 div, the reading is valid, otherwise the Meter displays.

I. Capacitance

Range	Resolution	Accuracy	Overload Protection
40nF	10pF	Under REL mode: $\pm(3\%+10)$	250V DC or AC rms
400nF	100pF	$\pm(3\%+8)$	
4 μ F	1nF		
40 μ F	10nF		
100 μ F	100nF	$\pm(4\%+8)$	

**** END ****

This operating manual is subject to change without notice.

UNI-T®

UNI-TREND TECHNOLOGY (CHINA) CO., LTD.

No6, Gong Ye Bei 1st Road,
Songshan Lake National High-Tech Industrial
Development Zone, Dongguan City,
Guangdong Province, China
Tel: (86-769) 8572 3888
<http://www.uni-trend.com>